

Made in Italy

2021

PRODUCT  
CATALOGUE





# BBC underwater world



Made in Italy





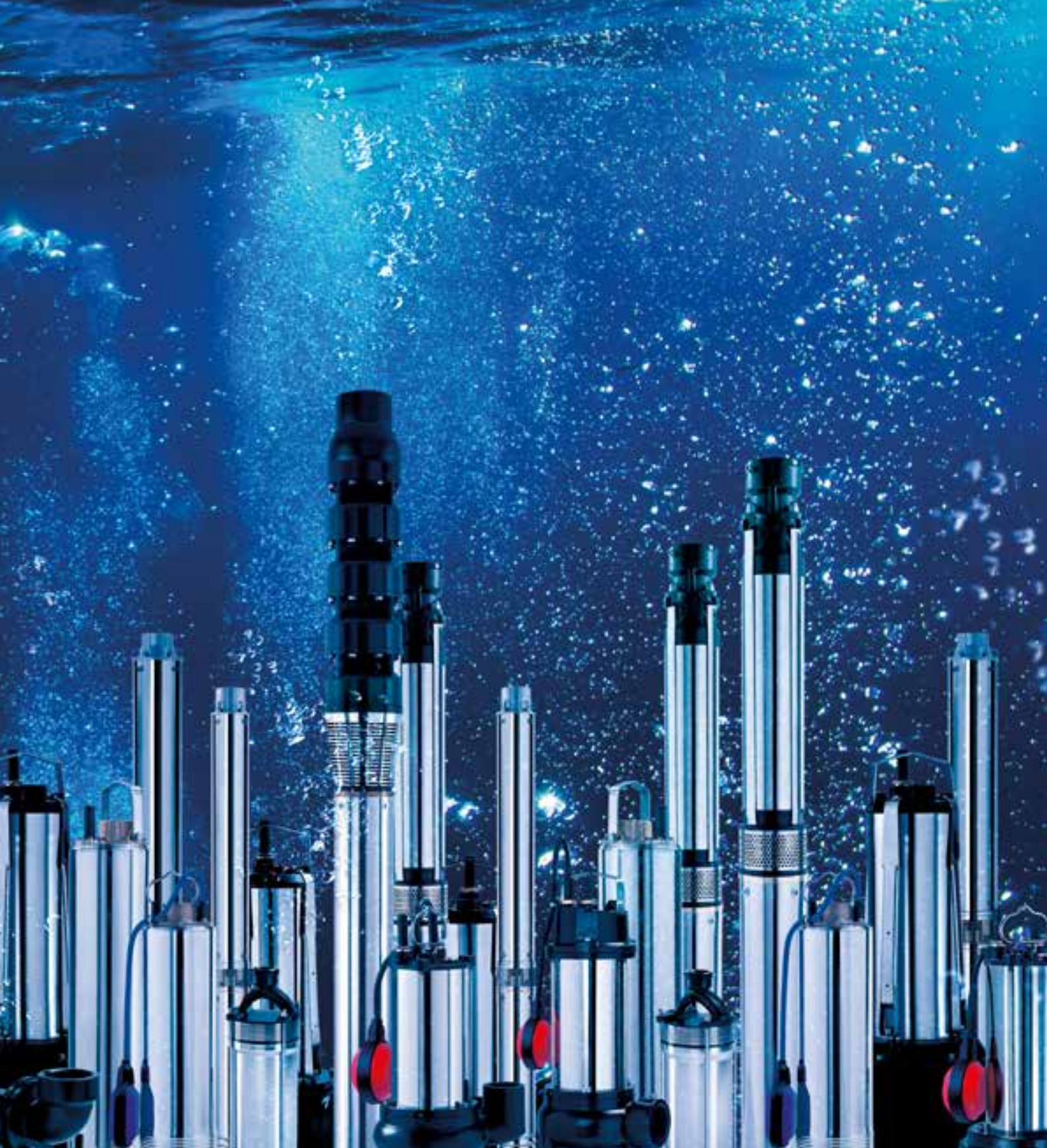

The aim of the Company, founded in **1959**, is to design, manufacture and deal with efficient and reliable electric pumps that can stand even the most severe applications. The experience achieved in this long period is daily exploited in the pursuit of materials, suppliers, new working and assembling methods so to preserve a high level of quality.

The balance between innovating and traditional principles together with the use of trustworthy components makes our products appreciated in the most different areas and markets.

An important achievement on the way both of growth and consolidation of our structure, has been, in 1997,

the certification of our Quality System according to **UNI EN ISO 9001** standards. Consequently, a deliberate acceptance of these international criteria is intended as a natural evolution towards a continuous enhancement.



# Clean water

p.6

**Electric submersible pumps  
TURBOSOM**  
for 6" boreholes



p.66

**Electric submersible pumps**  
for 8" boreholes



p.10

**Electric submersible pumps  
SR**  
for tanks and reservoirs



p.76

**External electric pumps  
CMO**  
horizontal multistage



p.34

**Electric submersible pumps  
IDROSOM**  
for 4" boreholes



p.80

**External electric pumps  
CV**  
vertical multistage



p.48

**Electric submersible pumps  
IDROSAND**  
for 6" boreholes



p.94

**Automatic  
booster sets**



# Photovoltaic

p.148

**Photovoltaic  
pumping stations  
ECOSOM**



p.154

**Photovoltaic  
pumping stations  
IDROSOLAR**





# Dirty water

## p.100

**NEW** Electric submersible pumps  
**DOMOSOM**

for domestic wastewater



## p.128

Electric submersible pumps  
**SEMISOM GR**

for sewage water with grinder



## p.104

Electric submersible pumps  
**SEMISOM**

for grey water



## p.132

Electric submersible pumps  
**SEMISOM /50 - /65**

for sewage water



## p.112

Electric submersible pumps  
**SEMISOM**

for sewage water



## p.140

Electric submersible pumps  
**SEMISOM /80**

for sewage water



## Related products

## p.160

Lifting station **SEMIBOX**

for sewage water



## p.162

Protection  
and control panels



## p.168

Accessories



## p.170

Pressure loss  
Selection of cables



# Clean water









# TURBOSOM 6"



# Electric submersible peripheral pumps TURBOSOM

for 6" boreholes



## APPLICATION

Single-stage electric submersible pumps for installations in domestic environments. Suitable to pump clean water from boreholes (with sand content not exceeding 20 g/m<sup>3</sup>). They are recommended to pressurize domestic water plants and for small irrigations.

## APPLICATION FEATURES

	TURBOSOM 57	TURBOSOM 77
IP rating	IP68	
Duty	Continuous S1	
Maximum immersion depth (m)	40	20
Max number of starts per hour	40	
Max temperature of the liquid pumped (°C)	50	
PH of the liquid pumped	6 - 10	
Maximum sand content (g/m <sup>3</sup> )	20	
Suitable for inverter drive	Three-phase versions only	
Suitable to operate horizontally		

## APPLICATION RANGE

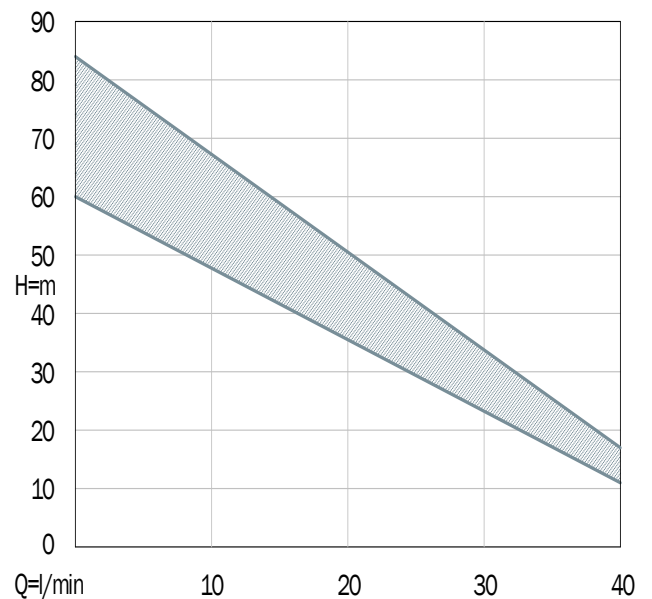

## CONSTRUCTION

Single-stage pump with peripheral impeller

Coolant filled, asynchronous, rewindable electric AC motor with short circuit rotor. Insulation Class F

Resin-insulated cable kit to prevent penetration of water inside the motor

## MATERIALS

Motor casing and tie-rods	Stainless Steel AISI304
Shaft	Stainless Steel AISI420B
Impeller, bolts and nuts	Brass OT58
Head, body and foot	Mechanical cast iron EN GJL-250
Seal rings	NBR rubber
Elastomers	NBR rubber
Cable	H07RN8-F Neoprene



# Electric submersible peripheral pumps TURBOSOM

for 6" boreholes

## PERFORMANCE DATA - 2 poles 50 Hz

Peripheral impeller 	Code	Version		P2				DNM (GAS)	Q m <sup>3</sup> /h l/min	Flow							Dimensions (mm)			Weight kg
				hp	kW	A	μF			0	0,36	0,72	1,08	1,5	1,8	2,4	A	B	C	
										0	6	12	18	25	30	40				
TURBOSOM 57	TM057	230 V	1-phase	0,75	0,55	3,8	16	1"	H (m)	60	54	48	40	31	25	11	334	236	136	12,6
	TT057	400 V	3-phase			1,6														
TURBOSOM 77	TM077	230 V	1-phase	1	0,75	6	20	1"	H (m)	84	75	66	56	44	35	17	349	251	136	14
	TT077	400 V	3-phase			2,3														

### SUPPLIED WITH

10 meters power cable



Control box containing capacitor and unipolar thermal protector switch (single-phase version)



### OPTIONS

20 meters power cable



30 meters power cable

### ACCESORIES

Code	Description
020811..	Three-phase electromechanical direct starter QT MT

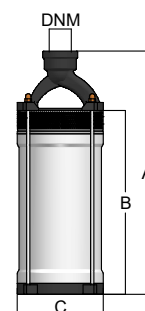

**PERFORMANCE CURVES - 2 poles 50 Hz**

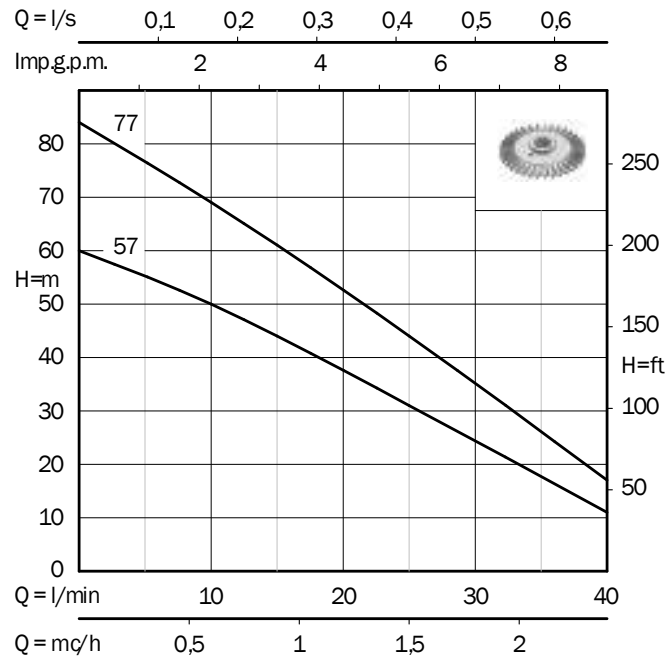



# SR



# Electric submersible pumps SR

## for tanks and reservoirs



### APPLICATION

Monobloc, multistage electric submersible pumps for installations in domestic, agricultural, civil and industrial environments. These electric pumps can suck liquid up to few centimetres from their bottom; they are consequently the ideal items to move clean water from tanks or rainwater harvesting reservoirs (in combination with the suction adaptor baseplate, available as accessory).

The series /80, /100, /140, /200 and /300 are certified to pump drinkable water.

The series /230, /330, /400 and /700 are designed for more professional and heavier applications; they can also pump water with a sand content up to 300 g/m<sup>3</sup>.

The series /80, powered with 24 V Direct Current, can be used in combination with the solar pumping stations ECOSOM.

### CONSTRUCTION

Series SR 100 - 140: AC asynchronous, rewindable electric dry motor with short circuit rotor with double mechanical seal and oil chamber in-between. Insulation Class F

Series SR 200 - 300: AC asynchronous, rewindable electric dry motor with short circuit rotor with double mechanical seal and oil chamber in-between. Insulation Class F; lubrication chamber for the ball bearing on the pump side

Series SR 230 - 330 - 400 - 700: Coolant filled, asynchronous, rewindable electric AC motor with short circuit rotor Insulation Class F

Series SR 80: 24V DC with permanent magnets motor. Insulation Class F

Resin-insulated cable kit to prevent penetration of water inside the motor

### APPLICATION RANGE

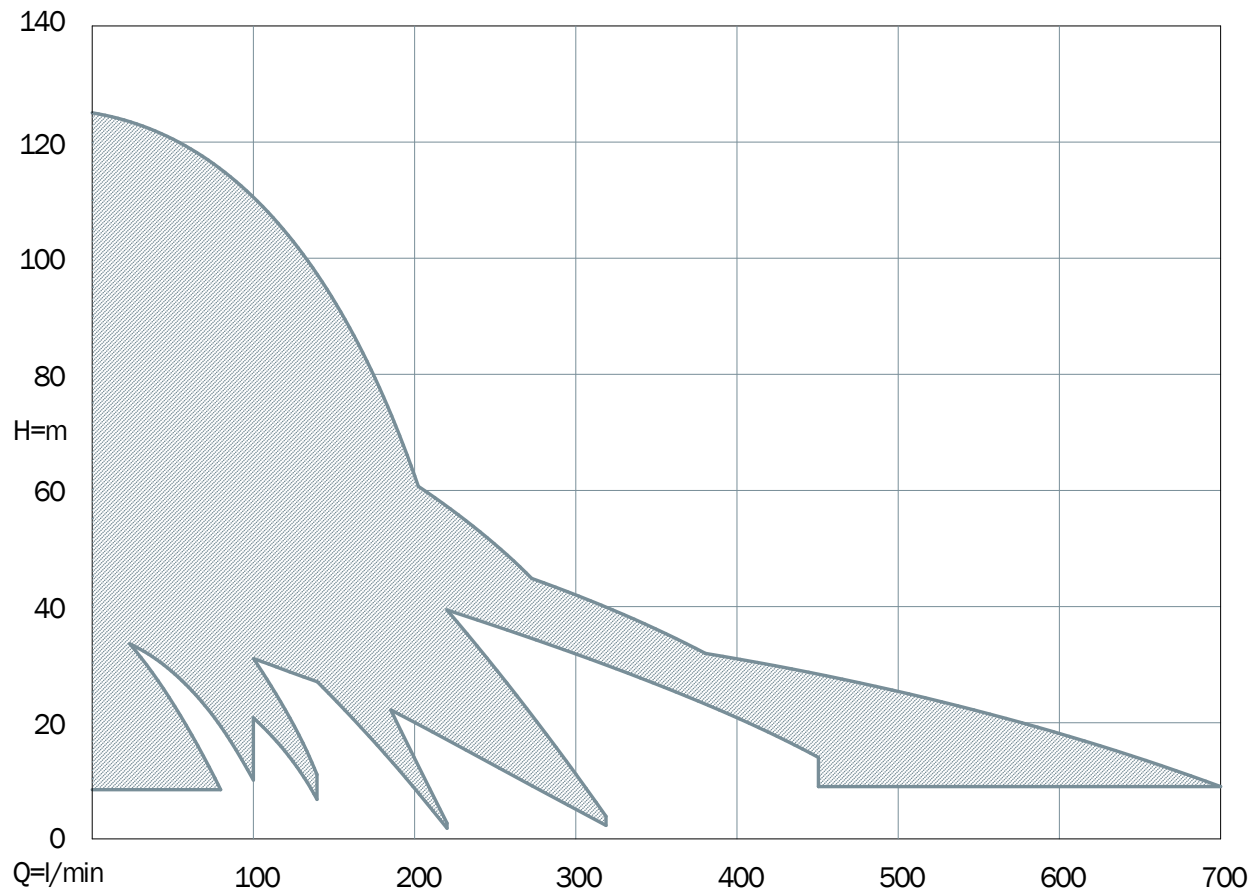



# Electric submersible pumps SR

for tanks and reservoirs



This important certification, released by an Agency accredited by the French Ministry of Health, attests that the electric pumps series SR -/100 /140 /200 /300 can be used to pump drinkable water.

## APPLICATION FEATURES

	SR		
	/100	/140	/80
IP rating	IP68		
Duty	Continuous S1		Limited use S2 (60 minutes)
Minimum level of the liquid to be pumped (mm)	100		
Maximum immersion depth (m)	30		
Max number of starts per hour	40		
Max temperature of the liquid pumped (°C)	50	45	
PH of the liquid pumped	6 - 10		
Maximum sand content (g/m <sup>3</sup> )	50		
Suitable for inverter drive	Three-phase versions only		
Not suitable to operate horizontally			

## MATERIALS

	SR		
	/100	/140	/80
Discharge, motor cover and central body	Brass OT58		
External casing, handle, motor casing, bolts and nuts	Stainless Steel AISI304		
Shaft	Stainless Steel AISI420B		
Impellers and diffusers	Noryl® reinforced with fibre-glass certified for drinkable water and Stainless Steel AISI304 wear rings		
Foot	Stainless Steel AISI304		
Mechanical seal	Silicon carbide and alumina		
Elastomers	NBR rubber		
Cable	PVC ACS AD8 (for permanent immersion in drinking water)		Twin Batt

## APPLICATION FEATURES

	SR					
	/200	/300	/230	/330	/400	/700
IP rating	IP68					
Duty	Continuous S1					
Minimum level of the liquid to be pumped (mm)	150		100		120	
Maximum immersion depth (m)	20		30			
Max number of starts per hour	40		30			
Max temperature of the liquid pumped (°C)	40					
PH of the liquid pumped	6 - 10					
Maximum sand content (g/m <sup>3</sup> )	50		200		300	
Suitable for inverter drive	Three-phase versions only					
Not suitable to operate horizontally						

## MATERIALS

	SR					
	/200	/300	/230	/330	/400	/700
Discharge, motor cover and central body	Brass OT58		Mechanical cast iron EN GJL-250			
External casing, handle, motor casing, bolts and nuts	Stainless Steel AISI304					
Shaft	Stainless Steel AISI420B		Stainless Steel AISI420B - AISI303			
Impellers and diffusers	Noryl® reinforced with fibre-glass certified for drinkable water and Stainless Steel AISI304 wear rings					
Body of the diffusers					Mechanical cast iron EN GJL-200	
Bearing of the diffusers					Anti-sand rubber	
Bearing of the shaft support			Desmopan® with rotating element in chromium-plated brass			
Foot	ABS		Mechanical cast iron EN GJL-250			
Mechanical Seal	Graphite and Alumina					
Elastomers	NBR rubber					
Cable	PVC ACS AD8 (for permanent immersion in drinking water)					



# Electric submersible pumps SR

for tanks and reservoirs



## PERFORMANCE DATA - 24 V Direct current

Radial Impeller 	P2		24 V DC			DNM (GAS)	Q	Flow										
	hp	kW	A					m <sup>3</sup> /h	0	0,36	0,6	1,2	1,8	2,4	3	3,6	4,2	4,8
							l/min	0	6	10	20	30	40	50	60	70	80	
<b>SERIES 80</b>																		
SR 4/80	0,75	0,55	28			1"¼	H (m)	40	38	37	34	30	26	21	17	11	7	

## PERFORMANCE DATA - 2 poles 50 Hz

Radial Impeller 	P2		1~230 V		3~400 V		DNM (GAS)	Q	Flow												
	hp	kW	A	µF	A	m <sup>3</sup> /h			0	1,2	2,4	3	3,6	4,2	4,8	5,4	6	6,6	7,2	7,8	8,4
							l/min	0	20	40	50	60	70	80	90	100	110	120	130	140	
<b>SERIES 100</b>																					
SR 3/100	0,7	0,5	4,2	16		1"¼	H (m)	35	33	30	28	25	22	18	14	9					
SR 4/100	0,9	0,65	5	16	2	1"¼		46	44	39	36	32	28	23	18	11					
SR 5/100	1,1	0,8	6,6	20	2,5	1"¼		58	55	49	46	40	36	29	23	15					
SR 6/100	1,3	0,95	7,3	25	2,9	1"¼		69	64	58	54	49	42	35	26	17					
SR 7/100	1,6	1,2	8,7	31,5	3,2	1"¼		80	75	68	62	56	48	40	30	20					
<b>SERIES 140</b>																					
SR 4/140	1	0,75	5,7	16	2,2	1"¼	H (m)	41	38	35	33	31	29	26	23	20	17	14	10	6	
SR 5/140	1,3	0,95	7,4	20	2,8	1"¼		51	48	44	41	38	35	32	29	25	21	17	13	8	
SR 6/140	1,6	1,2	8,3	25	3,2	1"¼		62	57	52	49	46	42	38	34	30	25	20	15	10	

**PERFORMANCE DATA - 2 poles 50 Hz**

Radial Impeller 	P2		1~230 V		3~400 V		DNM (GAS)	Q		Flow											
	hp	kW	A	µF	A	m³/h		0	1,2	3,6	6	8,4	11,4	13,2	14,4	15,6	16,8	18	19,2	24	27
								l/min	0	20	60	100	140	190	220	240	260	280	300	320	400
<b>SERIES 200</b>																					
SR 3/200	1,5	1,1	8	40	3	2"	H (m)	51	49	43	35	26	11	0,5							
SR 4/200	2	1,5	10	45	3,5	2"		68	65	57	47	35	15	1							
SR 5/200	3	2,2			5	2"		86	81	71	59	43	19	1,5							
<b>SERIES 230</b>																					
SR 11/230	4	3			8	2"	H (m)	103			91	79	55	39							
SR 13/230	5,5	4			10	2"		125			111	94	66	44							
<b>SERIES 300</b>																					
SR 2/300	1,5	1,1	8	40	3	2"	H (m)	36		33	30	26	19	16	13	10	7	4	1		
SR 3/300	2	1,5	10	45	3,5	2"		53		49	44	38	28,5	24	20	15	11	6,5	1,5		
SR 4/300	3	2,2			5	2"		71		64	58	51	38	32	26	20	15	8,5	2		
SR 5/300	4	3			7	2"		89		81	74	64	48	40	33	25	18	11	2,5		
<b>SERIES 330</b>																					
SR 9/330	5,5	4			10	2"	H (m)	89					67	58	53	47	41	34	27		
<b>SERIES 400</b>																					
SR 4/400	4	3			8	2"	H (m)	50					41	39	36	35	32	31	29	20	14
SR 5/400	5,5	4			10	2"		64						52	50	48	46	43	42	39	29
Semi-axial impeller 	P2		3~400 V			DNM (GAS)	Q		Flow												
	hp	kW	A	A	A		m³/h	0	1,2	3,6	6	8,4	13,2	15,6	18	19,2	24	27	33	36	42
								l/min	0	20	60	100	140	220	260	300	320	400	450	550	600
<b>SERIES 700</b>																					
SR 3/700	5,5	4		10		2"	H (m)	41						35	34,5	31	28	22	18	9	



# Electric submersible pumps SR series 80

for tanks and reservoirs

## PERFORMANCE DATA - 24 V Direct current

Radial Impeller 	Code	Version		P2		P1	A	Flow		DNM (GAS)	Dimensions (mm)			Weight kg
				hp	kW	kW		l/min	m		A	B	C	
SR 4/80	RF80/04/1	24 V	DC	0,75	0,55	0,67	28	6 - 30 - 80	38 - 30 - 7	1"¼	500	100	130	10,2

P1: Max. absorbed power - P2: Nominal power of the motor

### SUPPLIED WITH

5 meters power cable



### ACCESSORIES

Code	Description
03710037	Suction adaptor baseplate supplied with hose, non-return valve, strainer and float switch
02076100	Electromechanical direct starter Direct current QDC

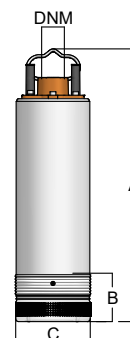
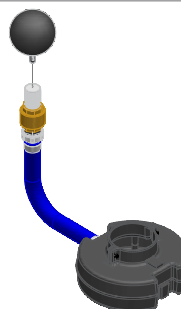

**PERFORMANCE CURVES - 24 V Direct current**

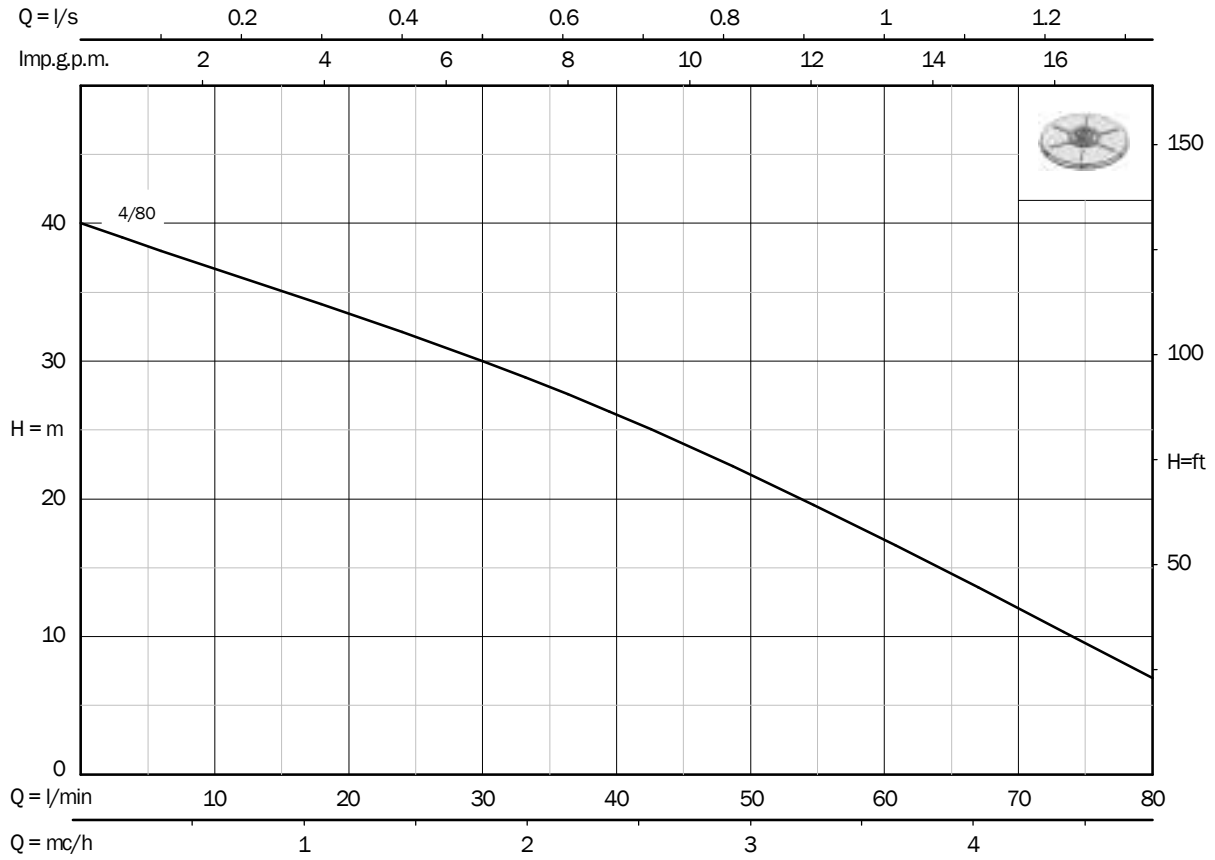
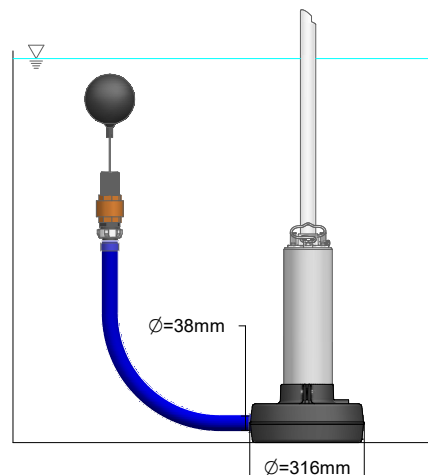

Illustration of how a suction adaptor baseplate can be installed





# Electric submersible pumps SR series 100

for tanks and reservoirs

## PERFORMANCE DATA - 2 poles 50 Hz

Radial Impeller 	Code	Version		P2		A	Flow		DNM (GAS)	Dimensions (mm)			Weight kg
				hp	kW		l/min	m		A	B	C	
SR 3/100	RM100/03/2	230 V	1-phase	0,7	0,5	4,2	20 - 50 - 100	33 - 28 - 9	1"¼	437	100	130	11,3
	RM100/03+G/2	230 V	1-phase+float										11,5
SR 4/100	RM100/04/2	230 V	1-phase	0,9	0,65	5	20 - 50 - 100	44 - 36 - 11	1"¼	461	100	130	11,5
	RM100/04+G/2	230 V	1-phase+float										11,7
	RT100/04/1	400 V	3-phase										2
SR 5/100	RM100/05/2	230 V	1-phase	1,1	0,8	6,6	20 - 50 - 100	55 - 46 - 15	1"¼	500	100	130	12,8
	RM100/05+G/2	230 V	1-phase+float										13
	RT100/05/1	400 V	3-phase										2,5
SR 6/100	RM100/06/2	230 V	1-phase	1,3	0,95	7,3	20 - 50 - 100	64 - 54 - 17	1"¼	544	100	130	14,5
	RM100/06+G/2	230 V	1-phase+float										14,7
	RT100/06/1	400 V	3-phase										2,9
SR 7/100	RM100/07/2	230 V	1-phase	1,6	1,2	8,7	20 - 50 - 100	75 - 62 - 20	1"¼	588	100	130	16,5
	RM100/07+G/2	230 V	1-phase+float										16,7
	RT100/07/1	400 V	3-phase										3,2

### SUPPLIED WITH

10 meters power cable



Capacitor (single-phase version)



Built-in thermal protection with manual reset (single-phase versions)



### OPTIONS

20 meters power cable

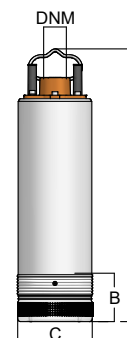

30 meters power cable

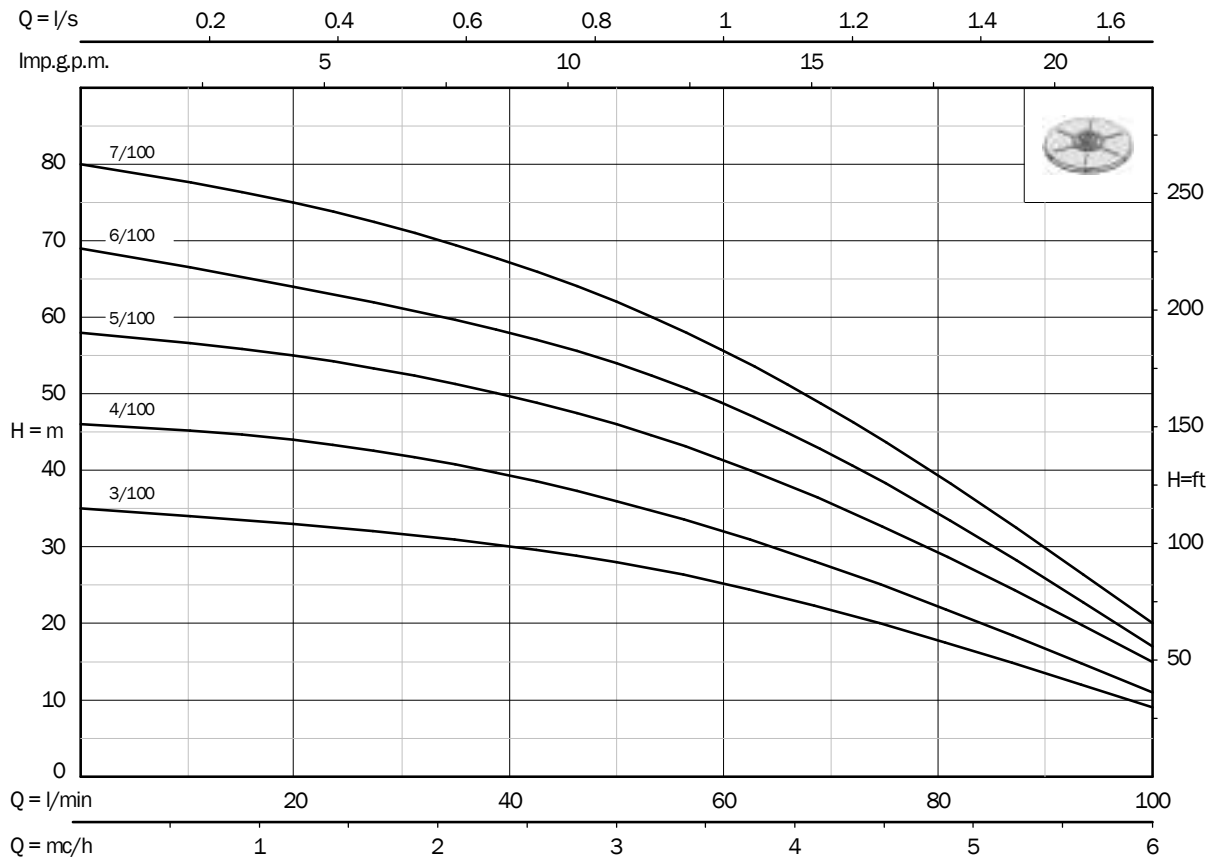

## PERFORMANCE CURVES - 2 poles 50 Hz

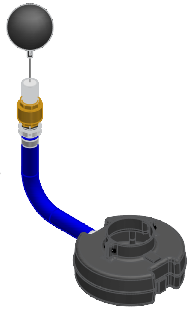

### ACCESSORIES

Code	Description
03710037	 <p>Suction adaptor baseplate supplied with hose, non-return valve, strainer and float switch</p>
020690..	 <p>Single-phase direct starter QM PT with bipolar, illuminated thermal protector switch with facility to wire the capacitor</p>
020811..	 <p>Three-phase electromechanical direct starter QT MT</p>

### Illustration of how a suction adaptor baseplate can be installed

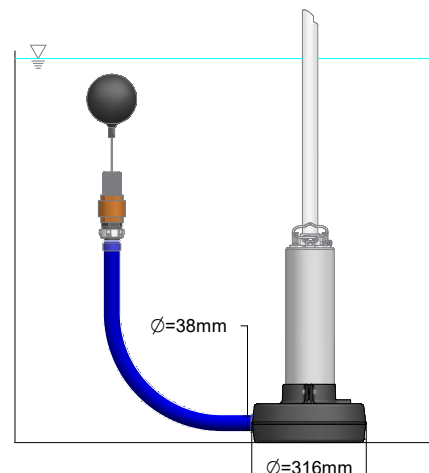



# Electric submersible pumps SR series 140

for tanks and reservoirs

## PERFORMANCE DATA - 2 poles 50 Hz

Radial Impeller 	Code	Version		P2		A	Flow		DNM (GAS)	Dimensions (mm)			Weight kg
				hp	kW		l/min	m		A	B	C	
SR 4/140	RM140/04/2	230 V	1-phase	1	0,75	5,7	20 - 90 - 140	38 - 23 - 6	1"1/4	461	100	130	11,6
	RM140/04+G/2	230 V	1-phase+float										11,8
	RT140/04/1	400 V	3-phase										2,2
SR 5/140	RM140/05/2	230 V	1-phase	1,3	0,95	7,4	20 - 90 - 140	48 - 29 - 8	1"1/4	500	100	130	13,2
	RM140/05+G/2	230 V	1-phase+float										13,4
	RT140/05/1	400 V	3-phase										2,8
SR 6/140	RM140/06/2	230 V	1-phase	1,6	1,2	8,3	20 - 90 - 140	57 - 34 - 10	1"1/4	544	100	130	14,6
	RM140/06+G/2	230 V	1-phase+float										14,8
	RT140/06/1	400 V	3-phase										3,2

### SUPPLIED WITH

10 meters power cable



Capacitor (single-phase version)



Built-in thermal protection with manual reset (single-phase versions)



### OPTIONS

20 meters power cable

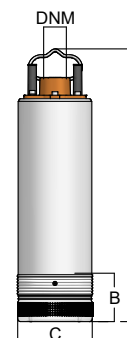

30 meters power cable

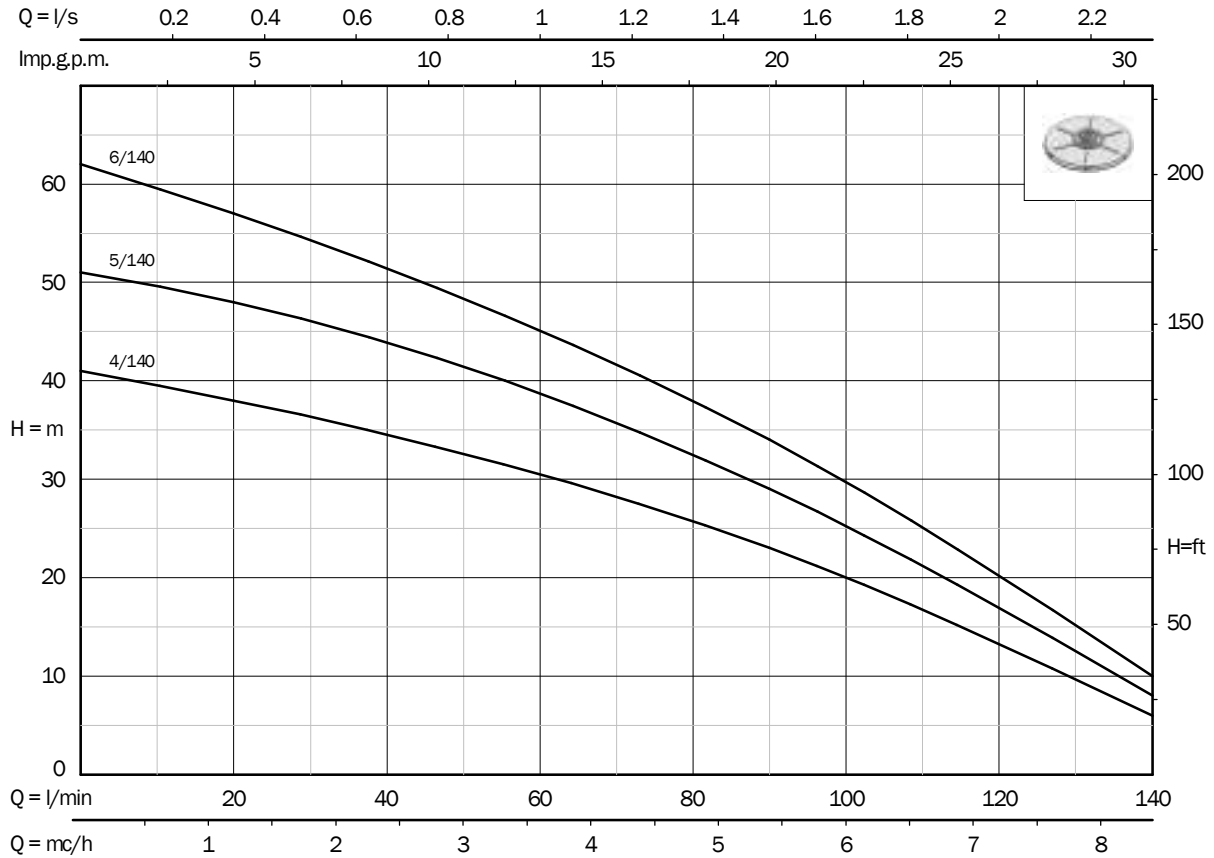

## PERFORMANCE CURVES - 2 poles 50 Hz

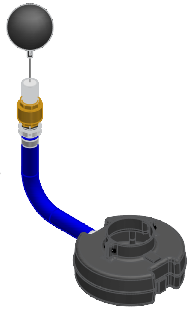

### ACCESSORIES

Code	Description
03710037	 <p>Suction adaptor baseplate supplied with hose, non-return valve, strainer and float switch</p>
020690..	 <p>Single-phase direct starter QM PT with bipolar, illuminated thermal protector switch with facility to wire the capacitor</p>
020811..	 <p>Three-phase electromechanical direct starter QT MT</p>

### Illustration of how a suction adaptor baseplate can be installed

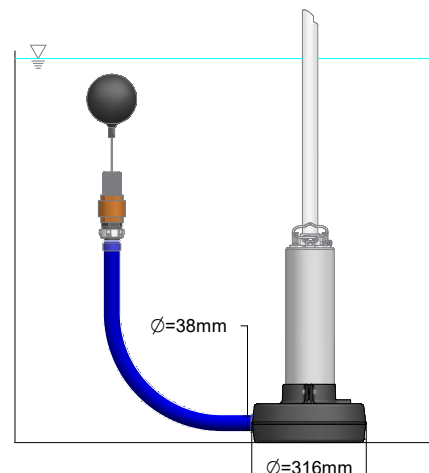

# Electric submersible pumps SR series 200

for tanks and reservoirs

## PERFORMANCE DATA - 2 poles 50 Hz

Radial Impeller 	Code	Version		P2		A	Flow		DNM (GAS)	Dimensions (mm)			Weight kg
				hp	kW		l/min	m		A	B	C	
SR 3/200	RM200/03	230 V	1-phase	1,5	1,1	8	20 - 140 - 220	49 - 26 - 0,5	2"	639	150	145	21,2
	RT200/03	400 V	3-phase			3							20,4
SR 4/200	RM200/04	230 V	1-phase	2	1,5	10	20 - 140 - 220	65 - 35 - 1	2"	700	150	145	24
	RT200/04	400 V	3-phase			3,5				675			20,8
SR 5/200	RT200/05	400 V	3-phase	3	2,2	5	20 - 140 - 220	81 - 43 - 1,5	2"	736	150	145	23,7

### SUPPLIED WITH



10 meters power cable



Capacitor (single-phase versions)



### ACCESSORI

Codice	Descrizione	
020690..	Single-phase direct starter QM PT with bipolar, illuminated thermal protector switch with facility to wire the capacitor	
020700..	Single-phase direct starter QM IT with bipolar, illuminated thermal protector switch with facility to wire the capacitor	
020811..	Three-phase electromechanical direct starter QT MT	

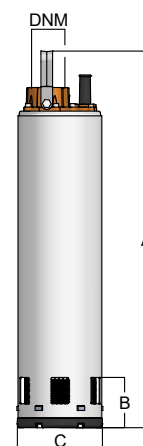



**PERFORMANCE CURVES - 2 poles 50 Hz**

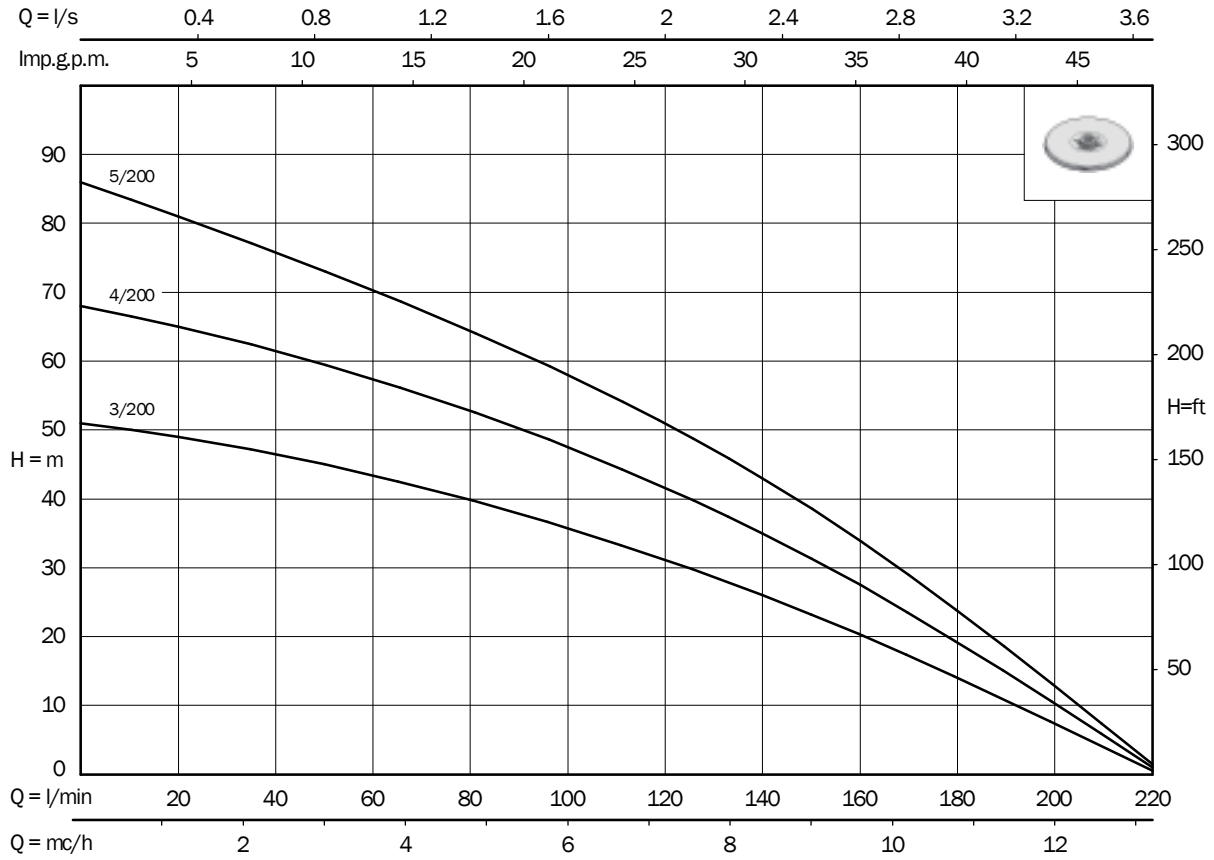

**ACCESSORIES**

Code	Description
020700..	Single-phase direct starter QM IT with bipolar, illuminated thermal protector switch with facility to wire the capacitor
020811..	Three-phase electromechanical direct starter QT MT

# Electric submersible pumps SR series 230

for tanks and reservoirs

## PERFORMANCE DATA - 2 poles 50 Hz

Radial Impeller 	Code	Version		P2		A	Flow		DNM (GAS)	Dimensions (mm)			Weight kg
				hp	kW		l/min	m		A	B	C	
SR 11/230	RT230/11	400 V	3-phase	4	3	8	100 - 180 - 220	91 - 61 - 39	2"	1375	100	142	37
SR 13/230	RT230/13	400 V	3-phase	5,5	4	10	100 - 180 - 220	111 - 72 - 44	2"	1496	100	142	42,4

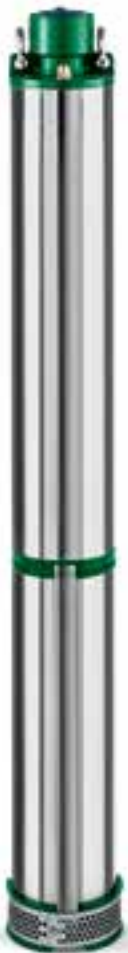



### SUPPLIED WITH

3 meters power cable



### ACCESSORIES

Code	Description
02081140	Three-phase Electromechanical direct starter QT MT 10 4 hp 
02081030	Three-phase Electromechanical direct starter AT 55 CL 5,5 hp 

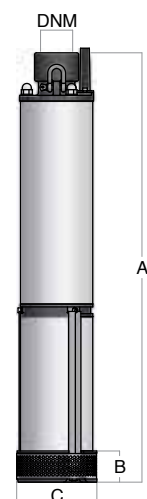

**PERFORMANCE CURVES - 2 poles 50 Hz**

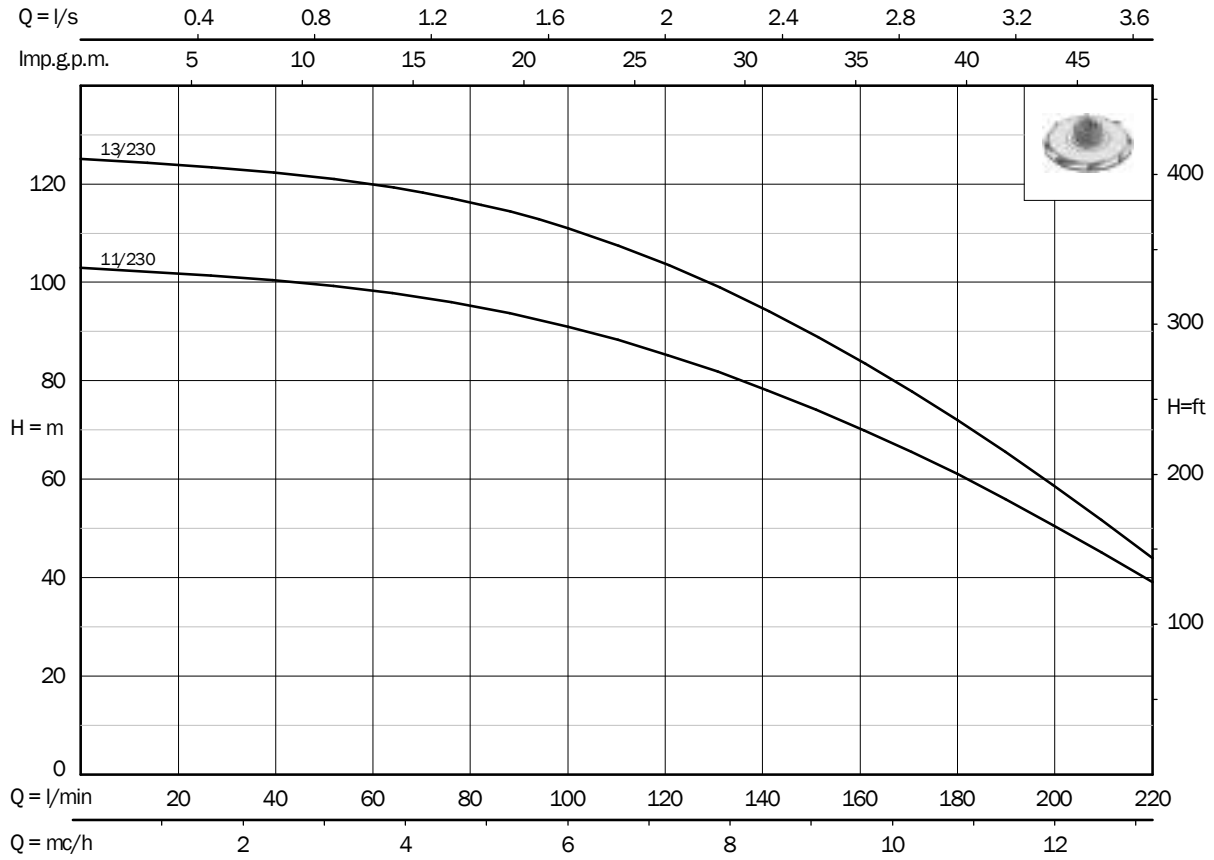



# Electric submersible pumps SR series 300

for tanks and reservoirs

## PERFORMANCE DATA - 2 poles 50 Hz

Radial Impeller 	Code	Version		P2		A	Flow		DNM (GAS)	Dimensions (mm)			Weight kg
				hp	kW		l/min	m		A	B	C	
SR 2/300	RM300/02	230 V	1-phase	1,5	1,1	8	60 - 220 - 320	33 - 16 - 1	2"	603	150	145	20
	RT300/02	400 V	3-phase			3							19,8
SR 3/300	RM300/03	230 V	1-phase	2	1,5	10	60 - 220 - 320	49 - 24 - 1,5	2"	664	150	145	23,3
	RT300/03	400 V	3-phase			3,5							20,3
SR 4/300	RT300/04	400 V	3-phase	3	2,2	5	60 - 220 - 320	64 - 32 - 2	2"	700	150	145	23,5
SR 5/300	RT300/05	400 V	3-phase	4	3	7	60 - 220 - 320	81 - 40 - 2,5	2"	776	150	145	27

### SUPPLIED WITH



10 meters power cable



Capacitor (single-phase versions)



### ACCESSORI

Codice	Descrizione	
020690..	Single-phase direct starter QM PT with bipolar, illuminated thermal protector switch with facility to wire the capacitor	
020700..	Single-phase direct starter QM IT with bipolar, illuminated thermal protector switch with facility to wire the capacitor	
020811..	Three-phase electromechanical direct starter QT MT	

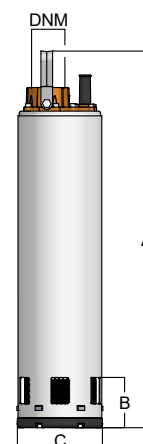

**PERFORMANCE CURVES - 2 poles 50 Hz**

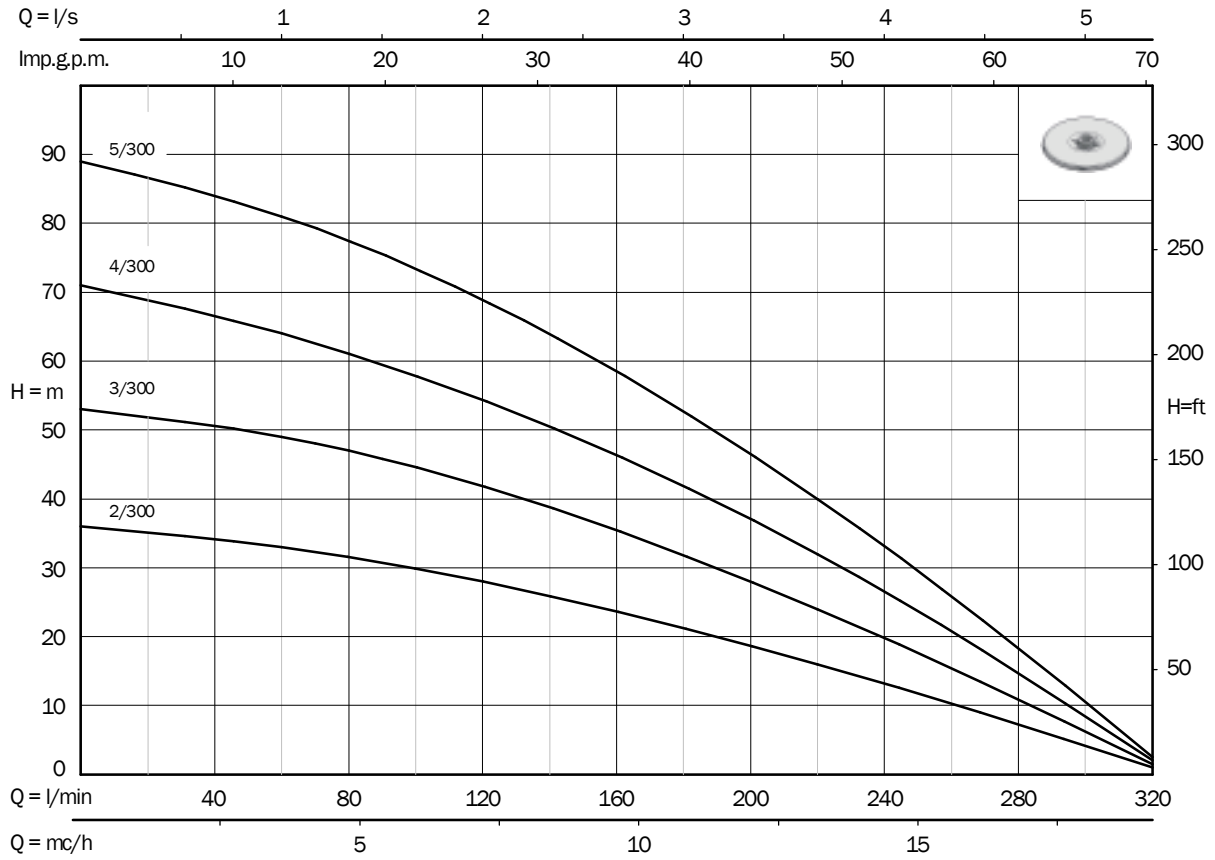

# Electric submersible pumps SR series 330

for tanks and reservoirs

## PERFORMANCE DATA - 2 poles 50 Hz

Radial Impeller 	Code	Version		P2		A	Flow		DNM (GAS)	Dimensions (mm)			Weight kg
				hp	kW		l/min	m		A	B	C	
SR 9/330	RT330/09	400 V	3-phase	5,5	4	10	180 - 260 - 320	68 - 47 - 27	2"	1352	100	142	39,4

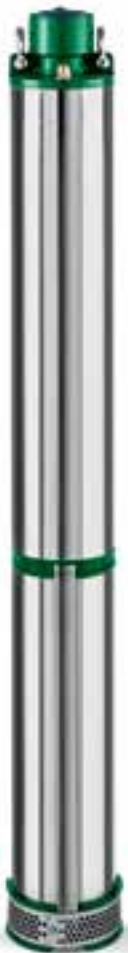

### SUPPLIED WITH

3 meters power cable



### ACCESSORIES

Code	Description
02081030	Three-phase Electromechanical direct starter AT 55 CL 5,5 hp

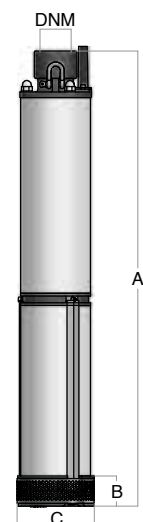

**PERFORMANCE CURVES - 2 poles 50 Hz**

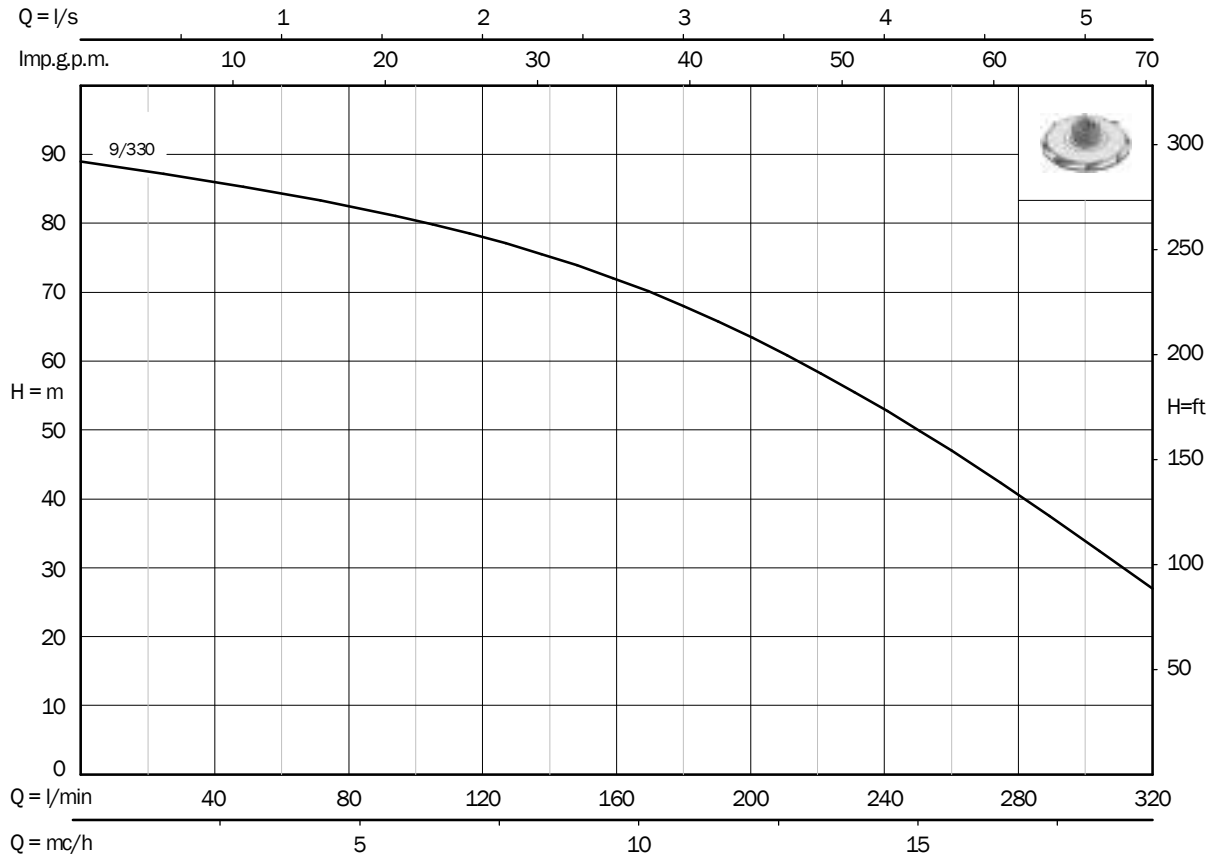



# Electric submersible pumps SR series 400

for tanks and reservoirs

## PERFORMANCE DATA - 2 poles 50 Hz

Radial Impeller 	Code	Version		P2		A	Flow		DNM (GAS)	Dimensions (mm)			Weight kg
				hp	kW		l/min	m		A	B	C	
SR 4/400	RT400/04	400 V	3-phase	4	3	8	190 - 300 - 450	41 - 31 - 14	2"	1185	100	142	39,5
SR 5/400	RT400/05	400 V	3-phase	5,5	4	10	190 - 300 - 450	52 - 42 - 20	2"	1284	100	142	44,4





### SUPPLIED WITH

3 meters power cable



### ACCESSORIES

Code	Description	
02081140	Three-phase Electromechanical direct starter QT MT 10 4 hp	
02081030	Three-phase Electromechanical direct starter AT 55 CL 5,5 hp	

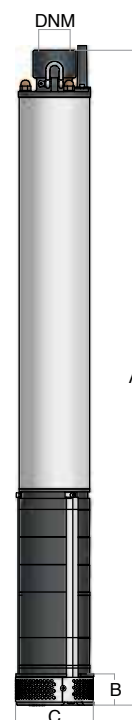

**PERFORMANCE CURVES - 2 poles 50 Hz**

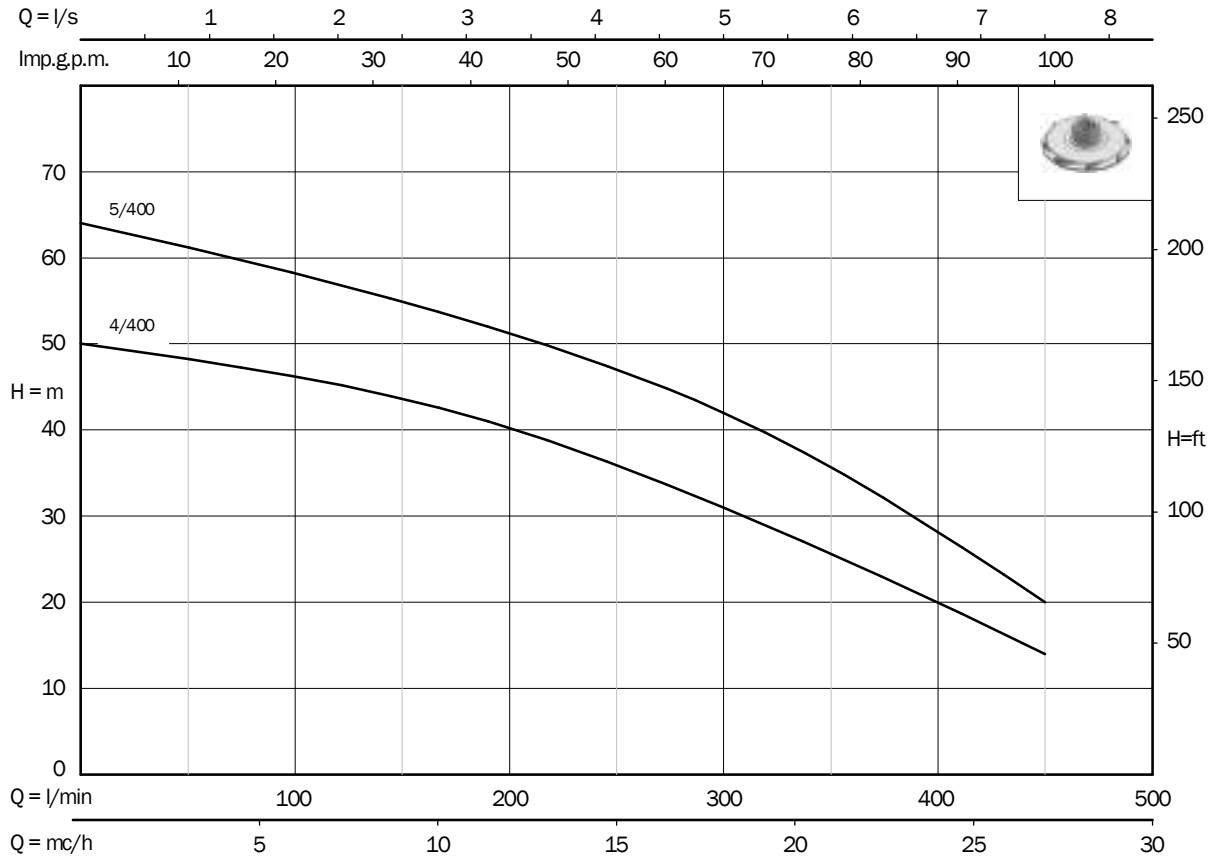

# Electric submersible pumps SR series 700

for tanks and reservoirs

## PERFORMANCE DATA - 2 poles 50 Hz

Semi-axial impeller 	Code	Version		P2		A	Flow		DNM (GAS)	Dimensions (mm)			Weight kg
				hp	kW		l/min	m		A	B	C	
SR 3/700	RT700/03	400 V	3-phase	5,5	4	10	300 - 500 - 700	35 - 25 - 9	2"	1262	120	142	38,9

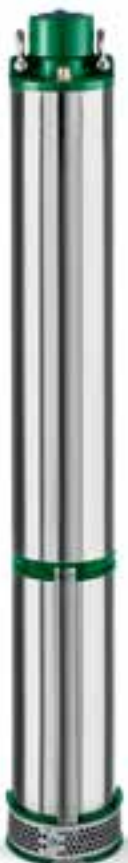

### SUPPLIED WITH

3 meters power cable



### ACCESSORIES

Code	Description
02081030	Three-phase Electromechanical direct starter AT 55 CL 5,5 hp



**PERFORMANCE CURVES - 2 poles 50 Hz**

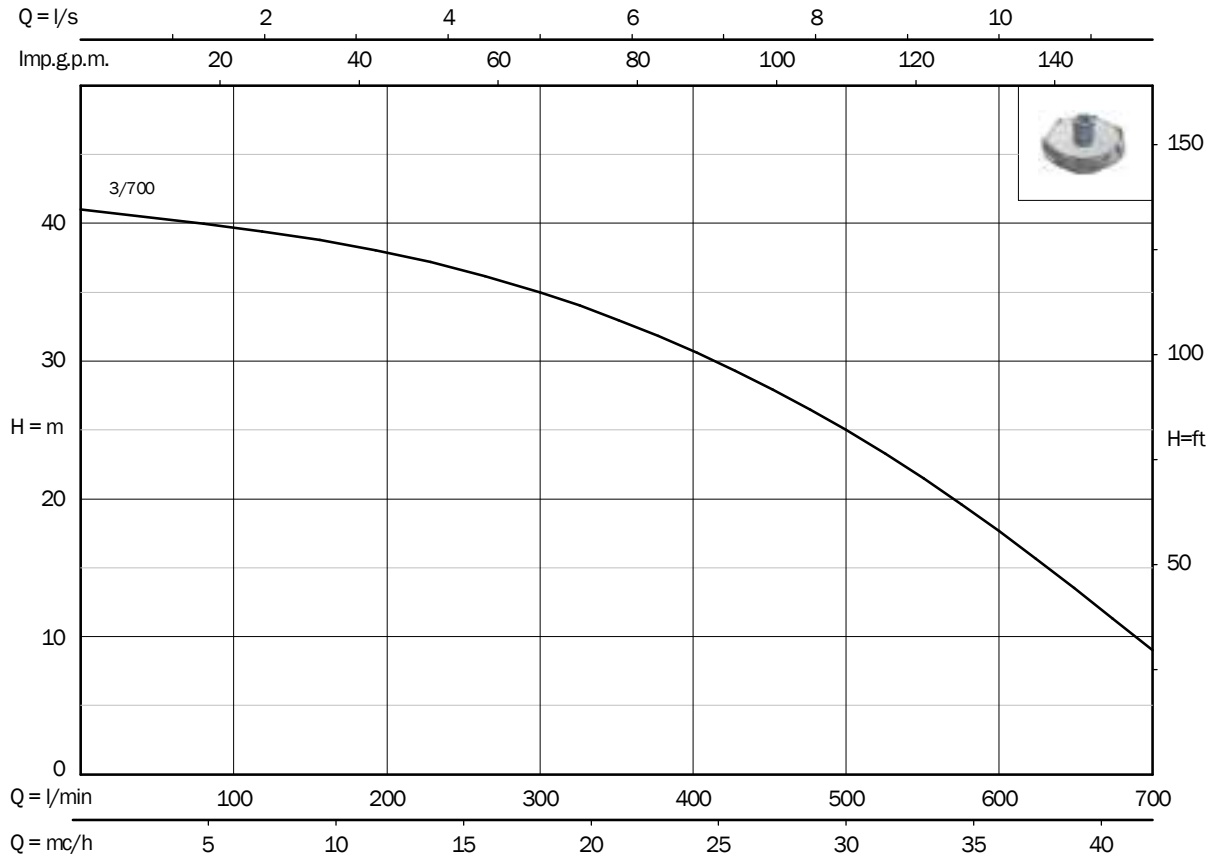



# IDROSOM 4"





# Electric submersible pumps IDROSOM

for 4" boreholes



## APPLICATION

Multistage electric submersible pumps for installations in domestic, agricultural, civil and industrial environments. Suitable to pump clean water from boreholes, tanks and reservoirs, they are designed to comply with the parameters of the European Directive ErP to ensure the best possible efficiency and reduce the consumption of energy to the lowest possible level. They are recommended to pressurize water plants in detached houses, block of flats, irrigation and fire-fighting systems.

## CONSTRUCTION

Eco-friendly design for water pumps. The submersible pumps Idrosom /60 and /100 successfully comply with the parameters of efficiency approved by the European commission on best technology available on the market (MEI Index  $\geq 0,7$ )

Coolant filled, asynchronous, rewindable electric AC motor with short circuit rotor. Insulation Class F

Resin-insulated cable kit to prevent penetration of water inside the motor ("S" series motors)

Shafts machined on ball bearings and mechanical seals location

Both shaft and coupling meet NEMA standards

## APPLICATION RANGE

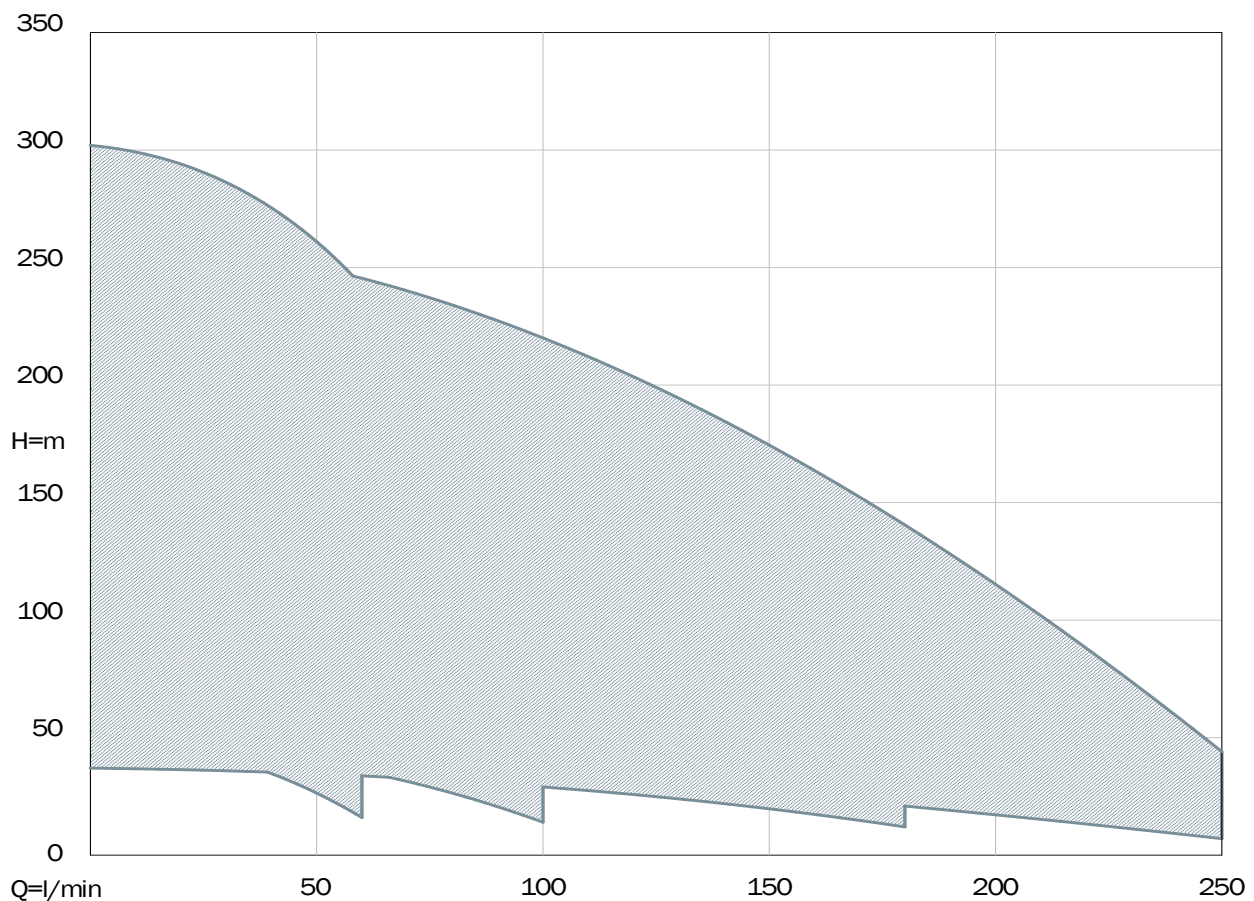

# Electric submersible pumps IDROSOM

for 4" boreholes



## ErP Directive

Eco-friendly design for water pumps. The submersible pumps Idrosom /60 and /100 successfully comply with the parameters of efficiency approved by the European commission on best technology available on the market (MEI Index  $\geq 0,7$ ).



## APPLICATION FEATURES - PUMP END

	IDROSOM			
	/60	/100	/180	/250
Minimum depth of the liquid to be pumped (m)	0,8			
Maximum temperature of the water to be pumped (°C)	60			
PH of the liquid pumped	6 - 10			
Maximum sand content (g/m <sup>3</sup> )	150			
Suitable to operate horizontally (included)	23/60	18/100	17/180	12/250

## MATERIALS - PUMP END

	IDROSOM			
	/60	/100	/180	/250
Head and suction body	Stainless Steel AISI304			
Casing, bolts and nuts	Stainless Steel AISI304			
Shaft	Stainless Steel AISI304			
Coupling	Stainless Steel AISI316			
Impellers and diffusers	Noryl® reinforced with fibre-glass, certified for drinking water			
Top bearing	Rubber with rotating element in Stainless Steel AISI316			

### APPLICATION FEATURES - MOTOR

	MOTOR	
	4" S series	4" E series
IP rating	IP68	
Duty	Continuous S1	
Maximum immersion depth (m)	150	
Maximum number of starts per hour	30	
Maximum temperature of the water pumped (°C)	35	
PH of the liquid pumped	6 - 10	
Suitable for inverter drive	Three-phase versions only	
Suitable to operate horizontally (Included)	5,5 hp	



### MATERIALS - MOTOR

	MOTOR	
	4" S series	4" E series
Casing	Stainless steel AISI304	
Shaft terminal	Stainless steel AISI303	Stainless steel AISI304
Upper body	Brass OT58	Nickel plated cast iron, with protection Stainless steel AISI304
Elastomers	NBR Rubber	
Mechanical seal	Graphite and alumina	
Cable	PVC ACS AD8 (for permanent immersion in drinking water)	Cross-linked rubber ACS AD8 (for permanent immersion in drinking water)



# Electric submersible pumps IDROSOM

for 4" boreholes

## PERFORMANCE DATA - PUMP ENDS - 2 poles 50 Hz

Radial impeller 	P2		DNM (GAS)	Q	Flow																
	hp	kW			m³/h	0	0,6	1,2	1,8	2,4	3	3,6	4,5	6	7,2	8,4	9,6	10,8	12	13,5	15
				l/min	0	10	20	30	40	50	60	75	100	120	140	160	180	200	225	250	
<b>SERIES 60</b>																					
IDROSOM 8/60	0,5	0,37	1"½	H (m)	49	48	45	41	35	27	16										
IDROSOM 12/60	0,75	0,55	1"½		74	73	69	62	52	40	24										
IDROSOM 15/60	1	0,75	1"½		92	90	85	78	66	50	30										
IDROSOM 23/60	1,5	1,1	1"½		140	137	130	119	101	77	45										
IDROSOM 30/60	2	1,5	1"½		184	179	169	155	132	100	59										
IDROSOM 43/60	3	2,2	1"½		263	257	243	222	189	144	84										
<b>SERIES 100</b>																					
IDROSOM 7/100	0,75	0,55	1"½	H (m)	45		44	43	41	39	36	29	14								
IDROSOM 9/100	1	0,75	1"½		57		55	54	53	50	46	38	18								
IDROSOM 14/100	1,5	1,1	1"½		88		86	85	82	78	72	60	28								
IDROSOM 18/100	2	1,5	1"½		113		110	107	104	99	91	76	36								
IDROSOM 27/100	3	2,2	1"½		170		167	163	156	148	137	112	53								
IDROSOM 36/100	4	3	1"½		226		220	215	208	197	182	151	71								
IDROSOM 48/100	5,5	4	1"½		302		295	288	277	261	242	200	96								
<b>SERIES 180</b>																					
IDROSOM 6/180	1	0,75	2"	H (m)	37					34	33	32	29	26	22	17	12				
IDROSOM 9/180	1,5	1,1	2"		55						50	49	48	44	38	32	26	18			
IDROSOM 12/180	2	1,5	2"		74						67	66	64	58	51	43	34	23			
IDROSOM 17/180	3	2,2	2"		104						96	94	91	82	72	61	48	33			
IDROSOM 24/180	4	3	2"		147						135	133	128	116	102	86	68	46			
IDROSOM 31/180	5,5	4	2"		190						174	171	165	149	131	111	87	59			
IDROSOM 42/180	7,5	5,5	2"		257						235	230	223	202	177	150	118	80			
<b>SERIES 250</b>																					
IDROSOM 6/250	1,5	1,1	2"	H (m)	40							35	33	32	29	26	23	19	14	7	
IDROSOM 8/250	2	1,5	2"		53								47	44	42	39	35	30	25	18	9
IDROSOM 12/250	3	2,2	2"		79								70	66	63	58	52	45	38	27	14
IDROSOM 17/250	4	3	2"		112								99	94	89	82	74	64	54	39	19
IDROSOM 22/250	5,5	4	2"		145								129	122	115	106	95	82	69	50	25
IDROSOM 30/250	7,5	5,5	2"		197								175	165	156	144	129	112	94	68	33
IDROSOM 40/250	10	7,5	2"		262								233	220	208	192	172	149	125	90	44

Motor and pump end can be supplied coupled exclusively with "S" series motors

**PERFORMANCE DATA - MOTORS - 2 poles 50 Hz**

	Code	Voltage	Number of phases	Capacitor	P2		Axial load	Rotation	Nominal current	Start current	Start Torque	Efficiency %	Power factor	Size of cable	Length of cable
					μF	hp	kW	F	η <sub>N</sub>	I <sub>N</sub>	I <sub>A</sub>	M <sub>A</sub>	η <sub>N</sub>		
		V	μF	hp	kW	N	min <sup>-1</sup>	A	A	Nm	η <sub>N</sub>	cos φ	mm <sup>2</sup>	m	
<b>"S" SERIES COOLANT FILLED SUBMERSIBLE MOTORS - for 4" boreholes</b>															
4M05	M4M05	230	1	20	0,5	0,37	2000	2870	3,6	12,5	1,1	52	0,89	4 x 1	2
4T05	M4T05	400	3					2900	1,8	9	6,1	57	0,5		
4M075	M4M075	230	1	25	0,75	0,55	2000	2800	4,4	12,5	1,1	60	0,93	4 x 1	2
4T075	M4T075	400	3					2850	2	9	6,1	64	0,7		
4M10	M4M10	230	1	31,5	1	0,75	2000	2810	6	17,4	1,42	59	0,93	4 x 1	2
4T10	M4T10	400	3					2805	2,3	9	6,1	66	0,75		
4M15	M4M15	230	1	40	1,5	1,1	2000	2800	8	22,9	2,2	65	0,92	4 x 1	2
4T15	M4T15	400	3					2800	3,2	12,8	12,1	68	0,74		
4M20	M4M20	230	1	50	2	1,5	2000	2820	11	37,4	2,3	67	0,9	4 x 1,5	2
4T20	M4T20	400	3					2815	4,2	13,6	16,3	71	0,76	4 x 1	
4M30	M4M30/2	230	1	60	3	2,2	2000	2830	15,7	48	3,3	68	0,91	4 x 1,5	2
4M30H	M4M30H	230	1	55			5000								
4T30	M4T30	400	3				2000								
4T30H	M4T30H	400	3				5000								
4T40	M4T40	400	3		4	3	5000	2815	8	35,2	27,9	72	0,73	4 x 1	2
4T55	M4T55	400	3		5,5	4	5000	2860	10	51,7	37,2	78	0,75	4 x 1,5	2
4T75	M4T75	400	3		7,5	5,5	5000	2840	12,5	67	48	80	0,85	4 x 1,5	4
4T100	M4T100	400	3		10	7,5	5000	2850	16,7	91	66,5	80	0,8	4 x 1,5	4
<b>"E" SERIES COOLANT FILLED SUBMERSIBLE MOTORS - for 4" boreholes</b>															
4M075	MYE4M075	230	1	25	0,75	0,55	2000	2810	4,7	16,5	1,3	57	0,88	4 x 1,5	1,7
4M10	MYE4M10	230	1	35				2825	5,9	18,9	1,72	62	0,9		
4T10	MYE4T10	400	3		1	0,75	2000	2825	2,5	9,4	5,1	63	0,77	4 x 1,5	1,7
4M15	MYE4M15	230	1	40	1,5	1,1	2000	2840	8,3	26,2	2,3	64	0,91		
4T15	MYE4T15	400	3					2825	3,4	15,5	9,64	68	0,69		
4M20	MYE4M20	230	1	60	2	1,5	2000	2845	10,7	35	3,27	66	0,93	4 x 1,5	1,7
4T20	MYE4T20	400	3					2835	4,8	18	10	71	0,63		

# Electric submersible pumps IDROSOM series 60

for 4" boreholes

## PERFORMANCE DATA - 2 poles 50 Hz

Radial impeller 	Pump Code	Motor		Version		P2		A	Flow		DNM (GAS)	Dimensions (mm)			Cable m	Weight kg
		Code	Series			hp	kW		l/min	m		A	B	C		
IDROSOM 8/60	P60/08	M4M05	S	230 V	1-phase	0,5	0,37	3,6	10 - 30 - 60	48 - 41 - 16	1"½	746	346	95	2	12
		M4T05	S	400 V	3-phase			1,8								12,1
IDROSOM 12/60	P60/12	M4M075	S	230 V	1-phase	0,75	0,55	4,4	10 - 30 - 60	73 - 62 - 24	1"½	837	346	95	2	12,6
		MYE4M075	E		1-phase			4,7								11,3
		M4T075	S	400 V	3-phase			2								12,7
IDROSOM 15/60	P60/15	M4M10	S	230 V	1-phase	1	0,75	6	10 - 30 - 60	90 - 78 - 30	1"½	935	376	95	2	14,4
		MYE4M10	E		1-phase			5,9								12,9
		M4T10	S	400 V	3-phase			2,3								13,1
		MYE4T10	E		3-phase			2,5								12,9
IDROSOM 23/60	P60/23	M4M15	S	230 V	1-phase	1,5	1,1	8	10 - 30 - 60	137 - 119 - 45	1"½	1145	406	95	2	16,9
		MYE4M15	E		1-phase			8,3								15,9
		M4T15	S	400 V	3-phase			3,2								15,5
		MYE4T15	E		3-phase			3,4								15
IDROSOM 30/60	P60/30	M4M20	S	230 V	1-phase	2	1,5	11	10 - 30 - 60	179 - 155 - 59	1"½	1396	456	95	2	20,4
		MYE4M20	E		1-phase			10,7								18,6
		M4T20	S	400 V	3-phase			4,2								18,1
		MYE4T20	E		3-phase			4,8								17,2
IDROSOM 43/60	P60/43	M4M30H	S	230 V	1-phase	3	2,2	15,7	10 - 30 - 60	257 - 222 - 84	1"½	1782	531	95	2	24,5
		M4T30H	S	400 V	3-phase			5,7								25,5

Motor and pump end can be supplied coupled exclusively with "S" series motors



### SUPPLIED WITH

Capacitor  
(for single-phase versions, "S" series)



### OPTIONS

10 meters cable

20 meters cable

30 meters cable



Available up to 1.1 kW single-phase and three-phase up to 3 kW

### ACCESSORIES

Code

Description

05405031

Non-return threaded valve 1"½ GAS

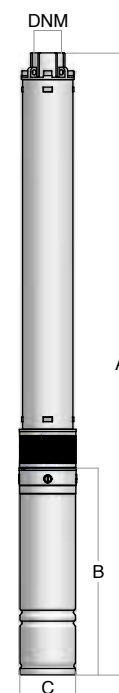

**PERFORMANCE CURVES - 2 poles 50 Hz**

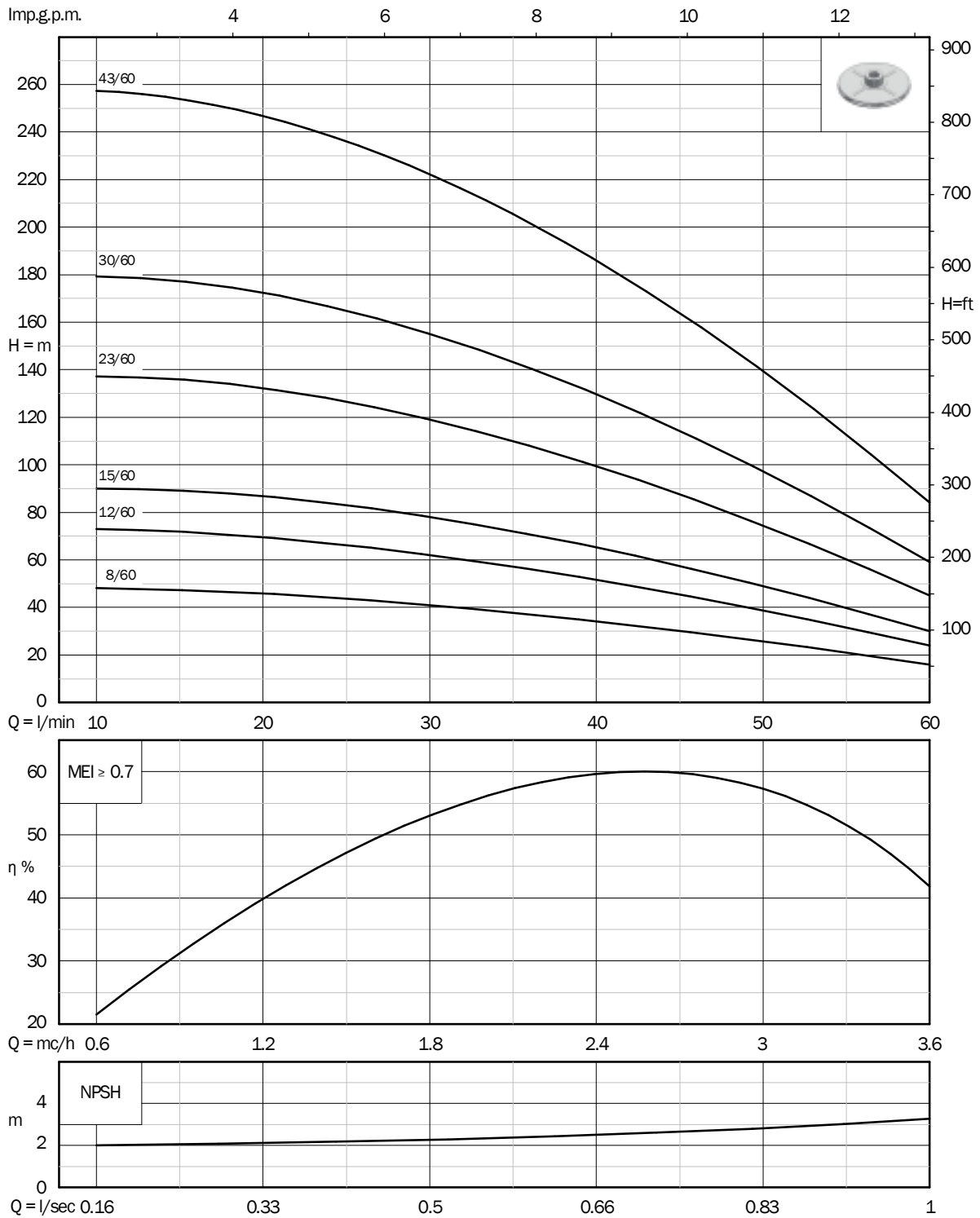

# Electric submersible pumps IDROSOM series 100

for 4" boreholes

## PERFORMANCE DATA - 2 poles 50 Hz

Radial impeller 	Pump Code	Motor		Version		P2		A	Flow		DNM (GAS)	Dimensions (mm)			Cable	Weight		
		Code	Series			hp	kW		l/min	m		A	B	C				
				230 V	1-phase			0,75							0,55	4,4	20 - 60 - 100	44 - 36 - 14
IDROSOM 7/100	P100/07	M4M075	S	230 V	1-phase	0,75	0,55	4,4	20 - 60 - 100	44 - 36 - 14	1"½	748	346	95	2	11,9		
		MYE4M075	E	400 V	3-phase			4,7				733	331				1,7	10,6
		M4T075	S	400 V	3-phase			2				748	346				2	12
IDROSOM 9/100	P100/09	M4M10	S	230 V	1-phase	1	0,75	6	20 - 60 - 100	55 - 46 - 18	1"½	830	376	95	2	13,6		
		MYE4M10	E	400 V	3-phase			5,9				810	356				1,7	12,1
		M4T10	S	400 V	3-phase			2,3				800	346				2	12,4
		MYE4T10	E	400 V	3-phase			2,5				810	356				1,7	12,2
IDROSOM 14/100	P100/14	M4M15	S	230 V	1-phase	1,5	1,1	8	20 - 60 - 100	86 - 72 - 28	1"½	990	406	95	2	15,8		
		MYE4M15	E	400 V	3-phase			8,3				970	386				1,7	14,8
		M4T15	S	400 V	3-phase			3,2				960	376				2	14,4
		MYE4T15	E	400 V	3-phase			3,4				955	371				1,7	13,9
IDROSOM 18/100	P100/18	M4M20	S	230 V	1-phase	2	1,5	11	20 - 60 - 100	110 - 91 - 36	1"½	1144	456	95	2	18,6		
		MYE4M20	E	400 V	3-phase			10,7				1124	436				1,7	16,8
		M4T20	S	400 V	3-phase			4,2				1346	406				2	16,4
		MYE4T20	E	400 V	3-phase			4,8				1326	386				1,7	15,5
IDROSOM 27/100	P100/27	M4M30/2	S	230 V	1-phase	3	2,2	15,7	20 - 60 - 100	167 - 137 - 53	1"½	1470	506	95	2	23		
		M4T30	S	400 V	3-phase			5,7				1420	456			20,3		
IDROSOM 36/100	P100/36	M4T40	S	400 V	3-phase	4	3	8	20 - 60 - 100	220 - 182 - 71	1"½	1729	531	95	2	24,6		
IDROSOM 48/100	P100/48	M4T55	S	400 V	3-phase	5,5	4	10	20 - 60 - 100	295 - 242 - 96	1"½	2167	587	95	2	30,4		

Motor and pump end can be supplied coupled exclusively with "S" series motors



### SUPPLIED WITH

Capacitor  
(for single-phase versions, "S" series)



### OPTIONS

10 meters cable

20 meters cable

30 meters cable



Available up to 1.1 kW single-phase and three-phase up to 3 kW

### ACCESSORIES

Code

Description

05405031

Non-return threaded valve 1"½ GAS

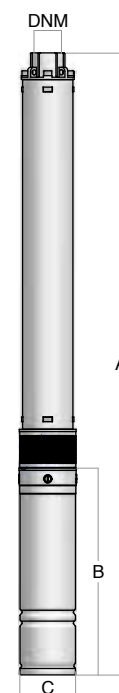



**PERFORMANCE CURVES - 2 poles 50 Hz**

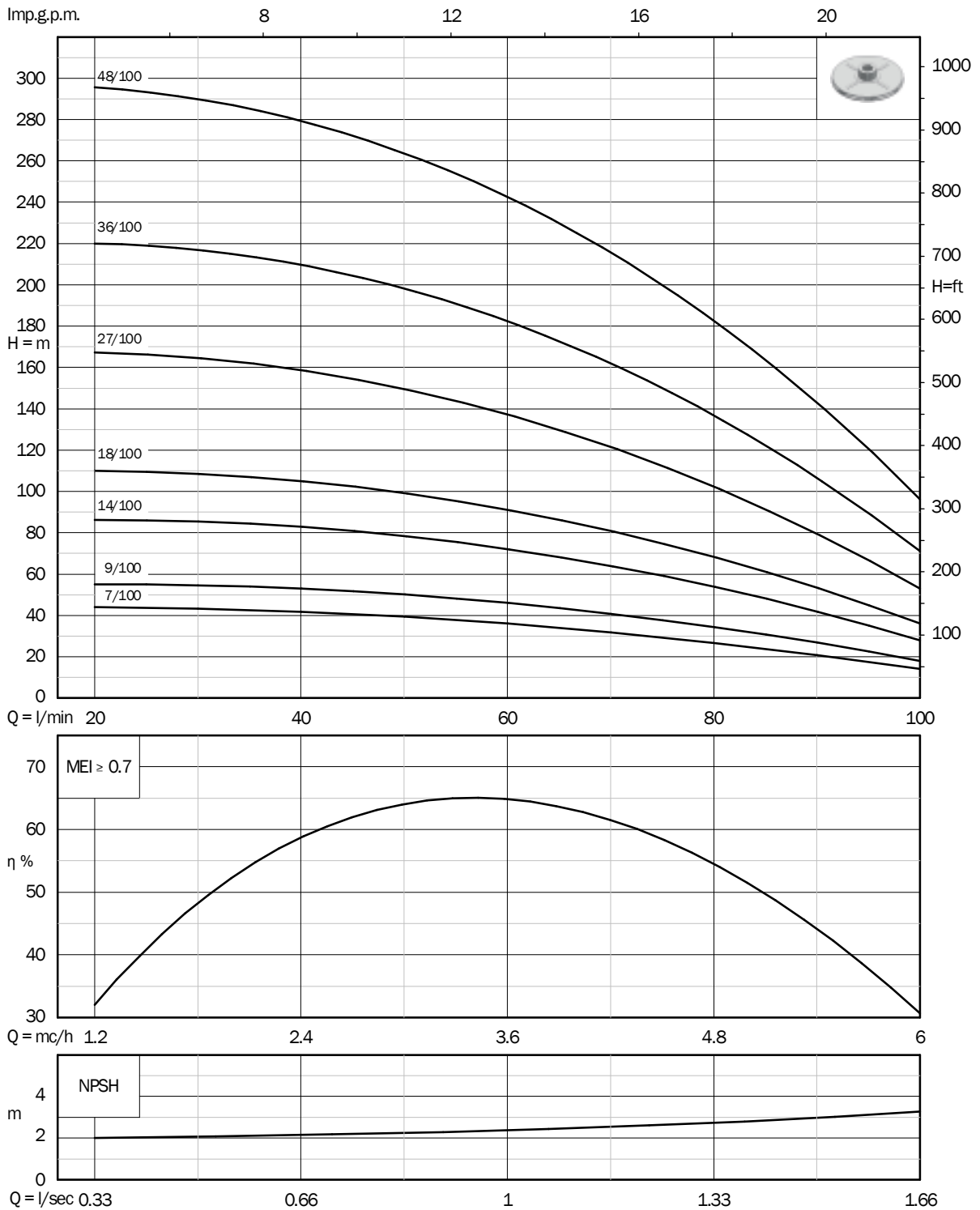

# Electric submersible pumps IDROSOM series 180

for 4" boreholes

## PERFORMANCE DATA - 2 poles 50 Hz

Radial impeller 	Pump Code	Motor		Versione		P2		A	Flow		DNM (GAS)	Dimensions (mm)			Cable	Weight
		Code	Series			hp	kW		l/min	m		A	B	C		
				230 V	1-phase			400 V							3-phase	
IDROSOM 6/180	P180/06/1	M4M10	S	230 V	1-phase	1	0,75	6	50 - 120 - 180	34 - 26 - 12	2"	817	376	95	2	13,5
		MYE4M10	E					5,9				797	356			
		M4T10	S	400 V	3-phase			2,3				787	346			
		MYE4T10	E					2,5				797	356			
IDROSOM 9/180	P180/09/1	M4M15	S	230 V	1-phase	1,5	1,1	8	50 - 120 - 180	50 - 38 - 18	2"	951	406	95	2	15,5
		MYE4M15	E					8,3				931	386			
		M4T15	S	400 V	3-phase			3,2				921	376			
		MYE4T15	E					3,4				916	371			
IDROSOM 12/180	P180/12/1	M4M20	S	230 V	1-phase	2	1,5	11	50 - 120 - 180	67 - 51 - 23	2"	1104	456	95	2	18,3
		MYE4M20	E					10,7				1084	436			
		M4T20	S	400 V	3-phase			4,2				1054	406			
		MYE4T20	E					4,8				1034	386			
IDROSOM 17/180	P180/17/1	M4M30/2	S	230 V	1-phase	3	2,2	15,7	50 - 120 - 180	96 - 72 - 33	2"	1370	506	95	2	21,4
		M4T30	S	400 V	3-phase			5,7				1320	456			19,7
IDROSOM 24/180	P180/24/1	M4T40	S	400 V	3-phase	4	3	8	50 - 120 - 180	135 - 102 - 46	2"	1637	531	95	2	
IDROSOM 31/180	P180/31/1	M4T55	S	400 V	3-phase	5,5	4	10	50 - 120 - 180	174 - 131 - 59	2"	1978	587	95	2	29,4
IDROSOM 42/180	P180/42/1	M4T75	S	400 V	3-phase	7,5	5,5	12,5	50 - 120 - 180	235 - 177 - 80	2"	2448	677	95	4	36,4

Motor and pump end can be supplied coupled exclusively with "S" series motors



### SUPPLIED WITH

Capacitor  
(for single-phase versions, "S" series)



### OPTIONS

10 meters cable

20 meters cable

30 meters cable



Available up to 1.1 kW single-phase and three-phase up to 3 kW

### ACCESSORIES

Code

Description

05405035

Non-return threaded valve 2" GAS

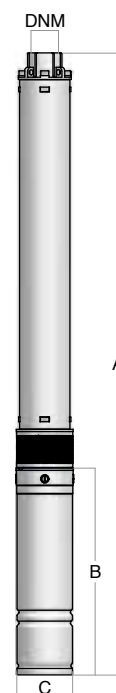

**PERFORMANCE CURVES - 2 poles 50 Hz**

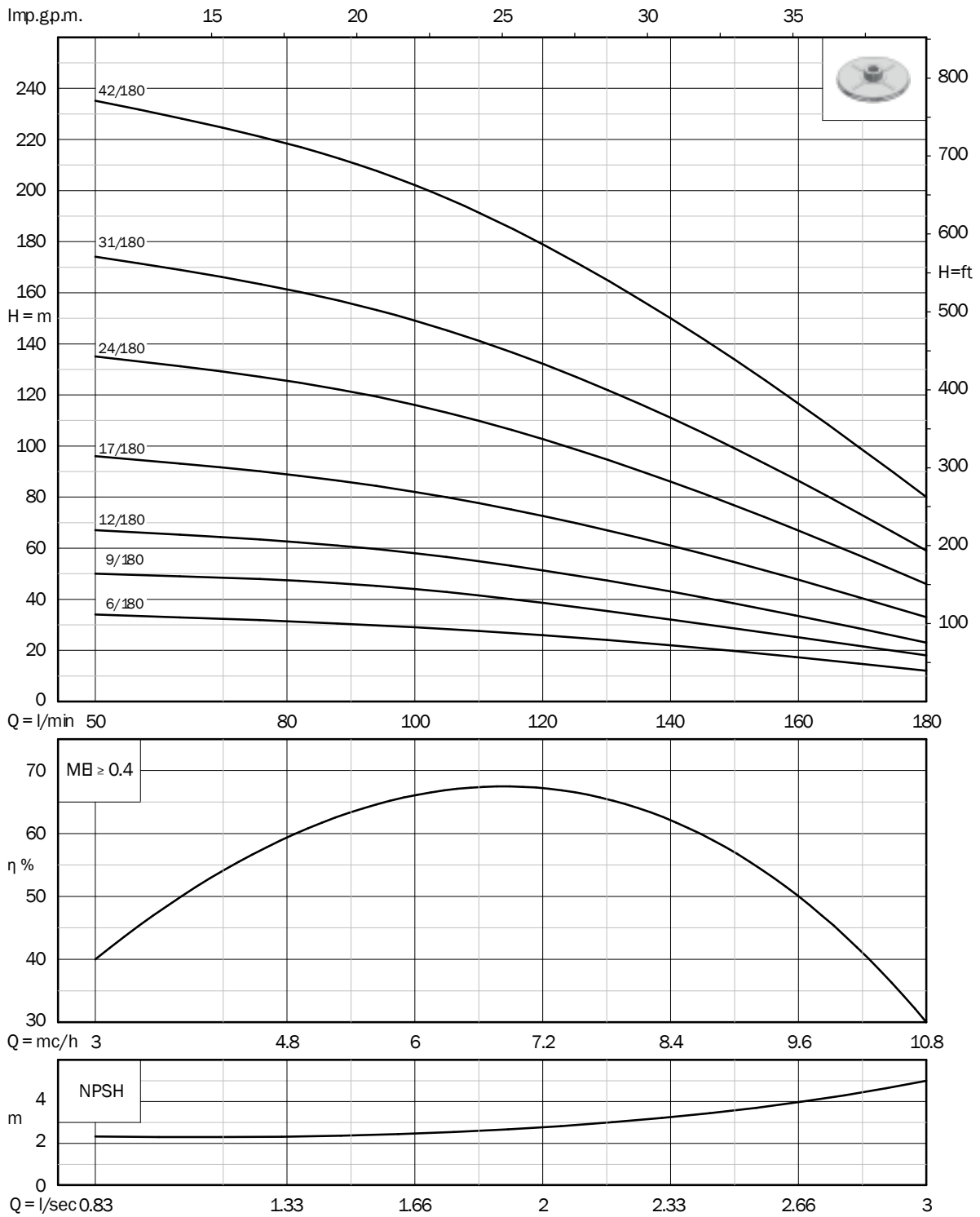

# Electric submersible pumps IDROSOM series 250

for 4" boreholes

## PERFORMANCE DATA - 2 poles 50 Hz

Radial impeller 	Pump Code	Motor		Version		P2		A	Flow		DNM (GAS)	Dimensions (mm)			Cable	Weight		
		Code	Series			hp	kW		l/min	m		A	B	C				
				230 V	1-phase			1,5							1,1	8	75 - 160 - 250	35 - 26 - 7
IDROSOM 6/250	P250/06	M4M15	S	230 V	1-phase	1,5	1,1	8	75 - 160 - 250	35 - 26 - 7	2"	876	406	95	2	15		
		MYE4M15	E					8,3				856	386				1,7	14
		M4T15	S	400 V	3-phase			3,2				846	376				2	13,6
		MYE4T15	E					3,4				841	371				1,7	13,1
IDROSOM 8/250	P250/08	M4M20	S	230 V	1-phase	2	1,5	11	75 - 160 - 250	47 - 35 - 9	2"	1005	456	95	2	17,7		
		MYE4M20	E					10,7				985	436				1,7	15,9
		M4T20	S	400 V	3-phase			4,2				955	406				2	15,4
		MYE4T20	E					4,8				935	386				1,7	14,5
IDROSOM 12/250	P250/12	M4M30/2	S	230 V	1-phase	3	2,2	15,7	75 - 160 - 250	70 - 52 - 14	2"	1213	506	95	2	20,2		
		M4T30	S	400 V	3-phase			5,7				1163	456			18,5		
IDROSOM 17/250	P250/17	M4T40	S	400 V	3-phase	4	3	8	75 - 160 - 250	99 - 74 - 19	2"	1479	531	95	2	22,8		
IDROSOM 22/250	P250/22	M4T55	S	400 V	3-phase	5,5	4	10	75 - 160 - 250	129 - 95 - 25	2"	1732	587	95	2	27,2		
IDROSOM 30/250	P250/30	M4T75	S	400 V	3-phase	7,5	5,5	12,5	75 - 160 - 250	175 - 129 - 33	2"	2180	677	95	4	34,7		
IDROSOM 40/250	P250/40	M4T100	S	400 V	3-phase	10	7,5	16,7	75 - 160 - 250	233 - 172 - 44	2"	2655	757	95	4	40,5		

Motor and pump end can be supplied coupled exclusively with "S" series motors



### SUPPLIED WITH

Capacitor  
(for single-phase versions, "S" series)



### OPTIONS

10 meters cable

20 meters cable

30 meters cable



Available up to 1.1 kW single-phase and three-phase up to 3 kW

### ACCESSORIES

Code

Description

05405035

Non-return threaded valve 2" GAS

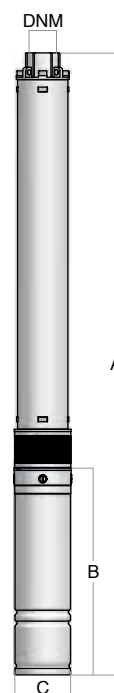

**PERFORMANCE CURVES - 2 poles 50 Hz**

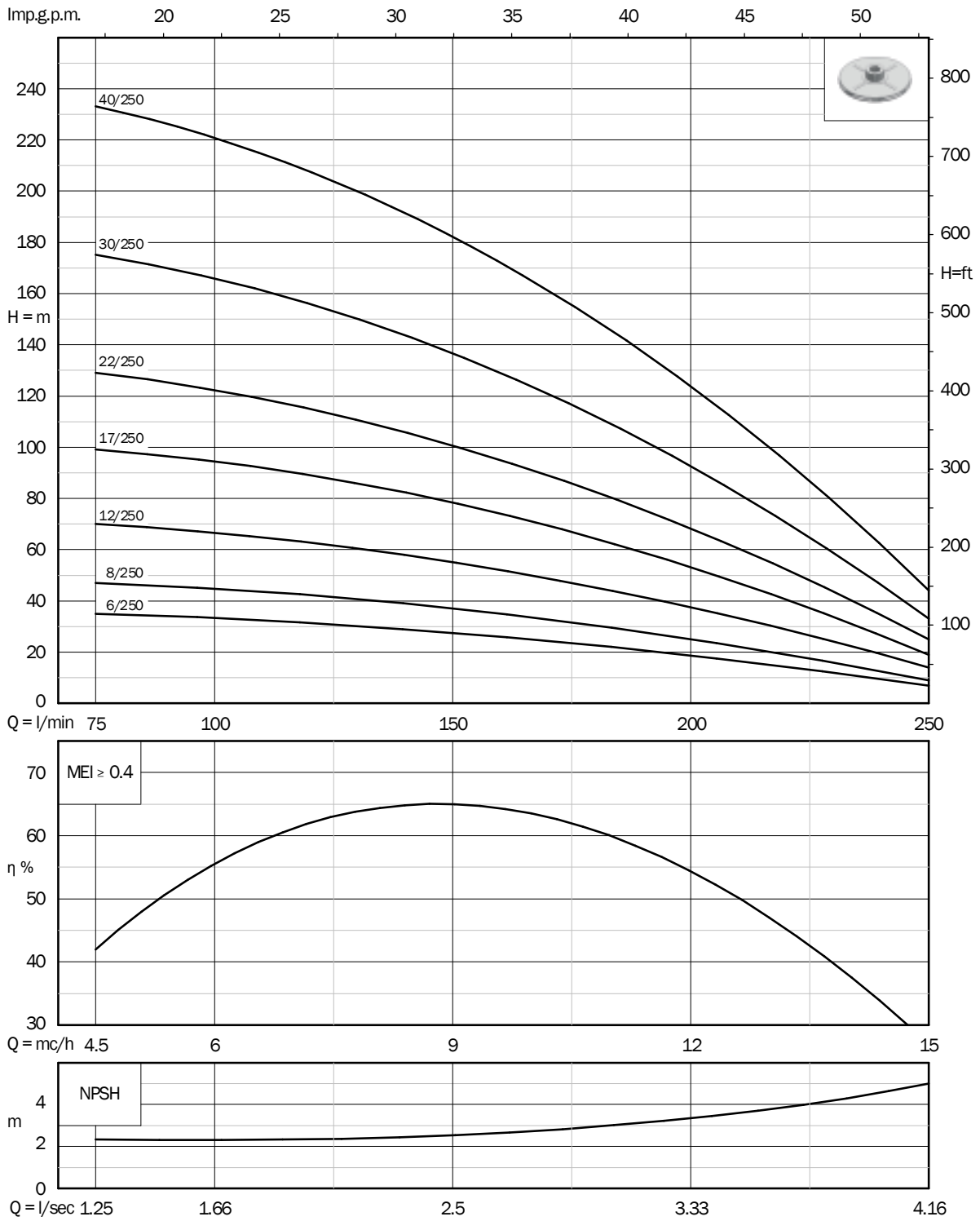



# IDROSAND 6"





# Electric submersible pumps IDROSAND

for 6" boreholes



## APPLICATION

Multistage electric submersible pumps for installations in agricultural, civil and industrial environments.

Suitable to pump clean water from boreholes, tanks and reservoirs.

They are recommended to pressurize water plants in block of flats, irrigation and fire-fighting systems.

The series IDROSAND (/230 /330 /530) are designed to comply with the parameters of the European Directive Erp to ensure the best possible efficiency and reduce the consumption of energy to the lowest possible level.

The series IDROSAND+ (/400 /700 /900), designed for more professional and heavier applications, are reliable and efficient even in case of water with high sand content (up to 450 g/m<sup>3</sup> of water pumped).

## CONSTRUCTION

Coolant filled, asynchronous, rewindable electric AC motor with short circuit rotor. Insulation Class F. (4" motors).

Water filled, asynchronous, rewindable electric AC motor with short circuit rotor. Insulation Class Y. (6" motors).

Shafts machined on support bushes and mechanical seals location

Both shaft and coupling meet NEMA standards

## APPLICATION RANGE

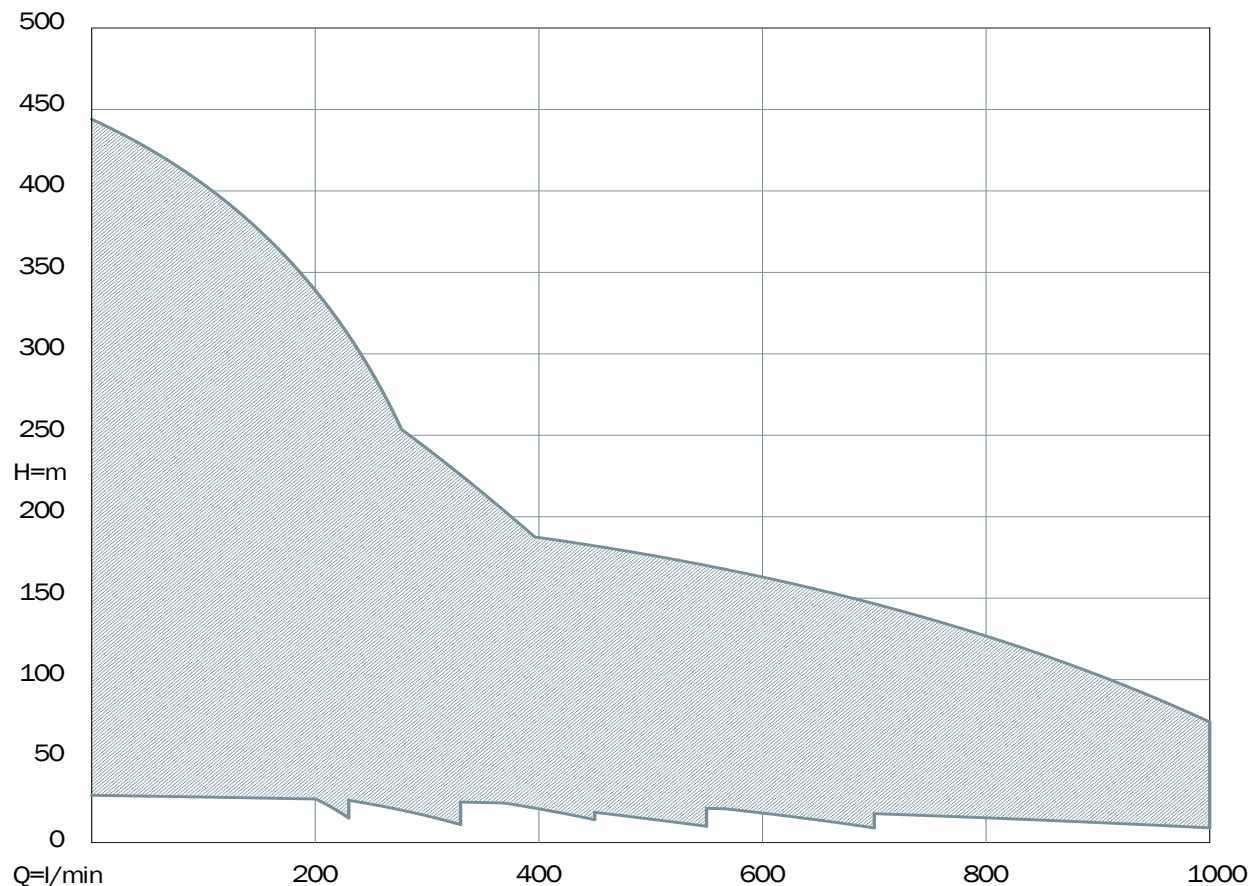

# Electric submersible pumps IDROSAND

for 6" boreholes



The electric pumps **IDROSAND** are designed to operate in the most arduous conditions, offering reliability even in applications with high sand content (**IDROSAND+** up to 450 g/m<sup>3</sup>).

## APPLICATION FEATURES - PUMP END

	IDROSAND			IDROSAND+		
	/230	/330	/530	/400	/700	/900
Minimum depth of the liquid to be pumped (m)	0,8					
Maximum temperature of the water to be pumped (°C)	60					
PH of the liquid pumped	6 - 10					
Maximum sand content (g/m <sup>3</sup> )	200			300	450	
Suitable to operate horizontally (included)	24/230	23/330	17/530	15/400	13/700	8/900

## MATERIALS - PUMP END

	IDROSAND			IDROSAND+		
	/230	/330	/530	/400	/700	/900
Head and suction body	Mechanical cast iron EN GJL-200					
Casing / Diffuser body	Stainless steel AISI304		Mechanical cast iron EN GJL-200	Stainless steel AISI304		
Tie-rods	Stainless steel AISI304		Steel	Stainless steel AISI304		
Shaft	Stainless steel AISI420B					
Coupling	Stainless steel AISI416B					
Impellers and diffusers	Noryl® reinforced with fibre-glass, certified for drinking water and AISI 304 stainless steel wear rings					
Diffuser bush				Anti-sand rubber		
Top bush	Desmopan® with rotating element in chromium-plated brass					
Check valve	Stainless steel AISI304					



### APPLICATION FEATURES - MOTOR

	MOTOR	
	4" S series	6"
IP rating	IP68	
Duty	Continuous S1	
Maximum immersion depth (m)	150	200
Maximum number of starts per hour	30	20
Maximum temperature of the water pumped (°C)	35	30
PH of the liquid pumped	6 - 10	
Suitable for inverter drive	All	
Suitable to operate horizontally (Included)	5,5 hp	All

### MATERIALS - MOTOR

	MOTOR	
	4" S series	6"
Casing	Stainless Steel AISI304	
Shaft Terminal	Stainless Steel AISI303	Stainless Steel AISI420B
Upper body	Brass OT58	Mechanical cast iron with electrophoresis paint EN GJL-250 or brass OT58
Elastomers	NBR rubber	
Mechanical seal	Graphite and alumina	
Foot		ABS
Cable	PVC ACS AD8 (for permanent immersion in drinking water)	



# Electric submersible pumps IDROSAND

for 6" boreholes

## PERFORMANCE DATA - PUMP ENDS - 2 poles 50 Hz

Radial impeller 	P2		DNM (GAS)	Q m³/h	Flow															
	hp	kW			0	5,4	7,2	9	10,2	12	13,8	15	16,8	18	19,8	21,6	24	27	30	33
					l/min	0	90	120	150	170	200	230	250	280	300	330	360	400	450	500
<b>SERIES 230</b>																				
IDROSAND 6/230	2	1,5	2"	H (m)	56	51	48	40	35	26	15									
IDROSAND 8/230	3	2,2	2"		75	67	61	52	45	34	20									
IDROSAND 9/230	3	2,2	2"		84	75	69	59	52	39	24									
IDROSAND 11/230	4	3	2"		103	93	86	74	66	51	33									
IDROSAND 14/230	5,5	4	2"		138	125	117	99	87	67	43									
IDROSAND 17/230	7,5	5,5	2"		164	150	139	118	103	80	52									
IDROSAND 20/230	7,5	5,5	2"		190	174	160	141	124	95	62									
IDROSAND 24/230	10	7,5	2"		234	207	191	166	147	114	77									
IDROSAND 28/230	10	7,5	2"		273	250	229	199	176	133	88									
IDROSAND 34/230	12,5	9,2	2"		334	307	282	241	212	162	106									
IDROSAND 40/230	15	11	2"		396	361	337	288	255	197	132									
<b>SERIES 330</b>																				
IDROSAND 4/330	2	1,5	2"	H (m)	39			34	32	29	26	24	19	16	11					
IDROSAND 5/330	3	2,2	2"		49			42	40	37	32	29	24	20	14					
IDROSAND 6/330	3	2,2	2"		58			48	46	43	38	34	28	23	16					
IDROSAND 7/330	4	3	2"		68			57	55	51	45	41	34	29	20					
IDROSAND 9/330	5,5	4	2"		89			74	71	64	56	50	41	34	24					
IDROSAND 10/330	5,5	4	2"		102			86	82	75	66	60	50	42	29					
IDROSAND 12/330	7,5	5,5	2"		121			101	96	87	77	69	57	48	33					
IDROSAND 14/330	7,5	5,5	2"		138			116	110	100	88	80	65	54	37					
IDROSAND 16/330	10	7,5	2"		160			134	127	116	104	94	78	65	46					
IDROSAND 19/330	10	7,5	2"		190			160	153	140	125	113	94	80	56					
IDROSAND 23/330	12,5	9,2	2"		233			198	190	175	157	143	119	101	72					
IDROSAND 28/330	15	11	2"		287			247	236	218	196	179	150	128	93					
IDROSAND 32/330	20	15	2"		326			285	274	252	226	205	172	148	108					
IDROSAND 36/330	20	15	2"		374			323	311	287	256	233	194	167	123					
IDROSAND 43/330	25	18,5	2"	444			383	367	339	304	276	231	198	145						
<b>SERIES 400</b>																				
IDROSAND+ 4/400	4	3	3"	H (m)	50			42	39	37	35,5	33	31	28	25	20	14			
IDROSAND+ 5/400	5,5	4	3"		64			53	51	49	47	44	42	38	35	29	20			
IDROSAND+ 6/400	5,5	4	3"		75			65	62	59	56	52	50	46	41	34	25			
IDROSAND+ 7/400	7,5	5,5	3"		90			76	73	69	66	62	59	54	48	40	29			
IDROSAND+ 8/400	10	7,5	3"		105			88	84	80	77	73	69	63	56	47	34			
IDROSAND+ 10/400	10	7,5	3"		130			110	105	100	97	90	86	78	70	58	42			
IDROSAND+ 12/400	12,5	9,2	3"		152			130	125	119	114	107	102	93	84	70	50			
IDROSAND+ 15/400	15	11	3"		190			160	155	148	142	132	126	116	104	87	63			
IDROSAND+ 20/400	20	15	3"		254			215	208	199	191	178	170	155	139	115	84			
IDROSAND+ 25/400	25	18,5	3"		312			268	259	247	237	221	210	192	172	143	104			
<b>SERIES 530</b>																				
IDROSAND 4/530	4	3	3"	H (m)	43				36		35	34	33	32	30	27	22	16	10	
IDROSAND 6/530	5,5	4	3"		64				53		52	50	49	48	45	40	33	24	16	
IDROSAND 8/530	7,5	5,5	3"		86				70	69	68	66	65	64	61	53	43	33	21	
IDROSAND 11/530	10	7,5	3"		118				97	95	94	92	90	87	83	73	60	44	29	
IDROSAND 14/530	12,5	9,2	3"		150				123	120	119	116	114	111	106	94	76	56	37	
IDROSAND 17/530	15	11	3"		182				149	146	145	141	139	135	129	113	93	69	45	
IDROSAND 22/530	20	15	3"		236				193	189	186	182	179	175	167	147	120	89	59	
IDROSAND 28/530	25	18,5	3"		300				246	240	237	232	228	223	213	187	152	113	75	
IDROSAND 33/530	30	22	3"		354				290	283	280	273	269	263	251	221	180	133	88	

Electric pumps supplied with 4" 'S' series motors up to 4 kW



## PERFORMANCE DATA - PUMP ENDS - 2 poles 50 Hz

Semi-axial impeller 	P2		DNM (GAS)	Q	Flow											
	hp	kW		m <sup>3</sup> /h	0	21	24	27	30	33	36	39	42	48	54	60
				l/min	0	350	400	450	500	550	600	650	700	800	900	1000
<b>SERIES 700</b>																
IDROSAND+ 3/700	5,5	4	3"	H (m)	41	34	31	28	25	22	18	14	9			
IDROSAND+ 5/700	7,5	5,5	3"		68	56	51	46	41	35	28	21	14			
IDROSAND+ 6/700	10	7,5	3"		84	65	59	54	48	42	34	27	17			
IDROSAND+ 8/700	12,5	9,2	3"		113	89	83	76	69	60	50	40	29			
IDROSAND+ 10/700	15	11	3"		141	112	104	96	86	75	62	50	36			
IDROSAND+ 13/700	20	15	3"		183	146	136	125	111	96	80	63	45			
IDROSAND+ 16/700	25	18,5	3"		223	177	164	150	134	116	96	75	54			
IDROSAND+ 19/700	30	22	3"		270	210	195	179	159	137	114	89	63			
<b>SERIES 900</b>																
IDROSAND+ 2/900	5,5	4	3"	H (m)	29		24	23	22	21	20	19	18	16	13	9
IDROSAND+ 3/900	7,5	5,5	3"		41		37	36	35	33,5	32	30	28	24	19	13
IDROSAND+ 4/900	10	7,5	3"		56		50	48	46	44	42	40	38	33	26	18
IDROSAND+ 5/900	12,5	9,2	3"		70		63	61	59	56	54	51	48	42	33	23
IDROSAND+ 6/900	15	11	3"		86		76	73,5	71	68	65	62	59	51	41	29
IDROSAND+ 8/900	20	15	3"		114		101	98	95	91	87	83	78	68	55	38
IDROSAND+ 10/900	25	18,5	3"		143		127	123	119	114	109	104	98	85	68	48
IDROSAND+ 12/900	30	22	3"		170		152	147	142	137	131	125	118	103	83	58
IDROSAND+ 15/900	40	30	3"		210		190	183	177	170	163	156	147	127	102	74

Electric pumps supplied with 4" 'S' series motors up to 4 kW

## PERFORMANCE DATA - MOTORS - 2 poles 50 Hz

Code	Voltage	Number of phases	P2		Axial load	Rotation	Nominal current	Start current	Start Torque	Efficiency %	Power factor	Size of cable	Length of cable	
			hp	kW	F	$\eta_N$	$I_N$	$I_A$	$M_A$	$\eta_N$	cos $\phi$			
			V	N	min <sup>-1</sup>	A	A	Nm	mm <sup>2</sup>			m		
<b>WATER FILLED SUBMERSIBLE MOTORS for 6" boreholes</b>														
6TA55	M6TA55/2	400	3	5,5	4	8000	2900	10,6	55	34	81	0,7	4 x 4	3
6TA75	M6TA75/2	400	3	7,5	5,5	8000	2840	12,8	55	34	81	0,77	4 x 4	3
6TA10	M6TA10/2	400	3	10	7,5	8000	2830	17	73	51	80	0,79	4 x 4	3
6TA125	M6TA125/2	400	3	12,5	9,2	8000	2830	21,5	90	69	80	0,78	4 x 4	3
6TA15	M6TA15/2	400	3	15	11	8000	2850	24,8	110	80	81	0,79	4 x 4	3
6TAH15	M6TA15H/2	400	3	15	11	18000	2850	24,8	110	80	81	0,79	4 x 4	3
6TA20	M6TA20/2	400	3	20	15	18000	2880	30,7	140	63	85	0,8	4 x 4	3
6TA25	M6TA25/2	400	3	25	18,5	18000	2870	39,6	160	74	85	0,8	4 x 6	3
6TA30	M6TA30/2	400	3	30	22	18000	2900	46	180	97	86	0,8	4 x 6	3
6TA35	M6TA35/2	400	3	35	26	18000	2910	55,5	270	130	88	0,76	4 x 6	3
6TA40	M6TA40/2	400	3	40	30	18000	2900	62	270	130	87	0,8	4 x 6	3
6TA50	M6TA50/2	400	3	50	37	18000	2900	81,8	360	155	87	0,8	4 x 6	3

# Electric submersible pumps IDROSAND series 230

for 6" boreholes

## PERFORMANCE DATA - 2 poles 50 Hz

Radial impeller 	Pump Code	Motor Code	Version		P2		A	Flow		DNM (GAS)	Dimensions (mm)			Cable m	Weight kg
					hp	kW		l/min	m		A	B	C		
IDROSAND 6/230	P230/06	M4M20	230 V	1-phase	2	1,5	11	90 - 150 - 230	51 - 40 - 15	2"	1142	456	146	2	31
		M4T20	400 V	3-phase			4,2				1092	406	146		
IDROSAND 8/230	P230/08	M4M30/2	230 V	1-phase	3	2,2	15,7	90 - 150 - 230	67 - 52 - 20	2"	1264	506	146	2	34
		M4T30	400 V	3-phase			5,7				1214	456	146		
IDROSAND 9/230	P230/09	M4M30/2	230 V	1-phase	3	2,2	15,7	90 - 150 - 230	75 - 59 - 24	2"	1300	506	146	2	37,3
		M4T30	400 V	3-phase			5,7				1250	456	146		
IDROSAND 11/230	P230/11	M4T40	400 V	3-phase	4	3	8	90 - 150 - 230	93 - 74 - 33	2"	1397	531	146	2	36,8
IDROSAND 14/230	P230/14	M4T55	400 V	3-phase	5,5	4	10	90 - 150 - 230	125 - 99 - 43	2"	1561	587	146	2	41,9
IDROSAND 17/230	P230/17	M6TA75/2	400 V	3-phase	7,5	5,5	12,8	90 - 150 - 230	150 - 118 - 52	2"	1754	672	146	3	66
IDROSAND 20/230	P230/20	M6TA75/2	400 V	3-phase	7,5	5,5	12,8	90 - 150 - 230	174 - 141 - 62	2"	1862	672	146	3	67,7
IDROSAND 24/230	P230/24	M6TA10/2	400 V	3-phase	10	7,5	17	90 - 150 - 230	207 - 166 - 77	2"	2031	697	146	3	73,3
IDROSAND 28/230	P230/28	M6TA10/2	400 V	3-phase	10	7,5	17	90 - 150 - 230	250 - 199 - 88	2"	2175	697	146	3	75,9
IDROSAND 34/230	P230/34	M6TA125/2	400 V	3-phase	12,5	9,2	21,5	90 - 150 - 230	307 - 241 - 106	2"	2488	722	146	3	83,2
IDROSAND 40/230	P230/40	M6TA15H/2	400 V	3-phase	15	11	24,8	90 - 150 - 230	361 - 288 - 132	2"	2744	762	146	3	93

Electric pumps supplied with 4" 'S' series motors up to 4 kW



### SUPPLIED WITH

Capacitor (single-phase versions)



### OPTIONS

Pump end with two cables

Version for star-delta motors 400/690 V (for 6" motors)

Version with brass motor body (for 6" motors)

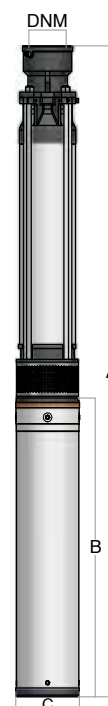

**PERFORMANCE CURVES - 2 poles 50 Hz**

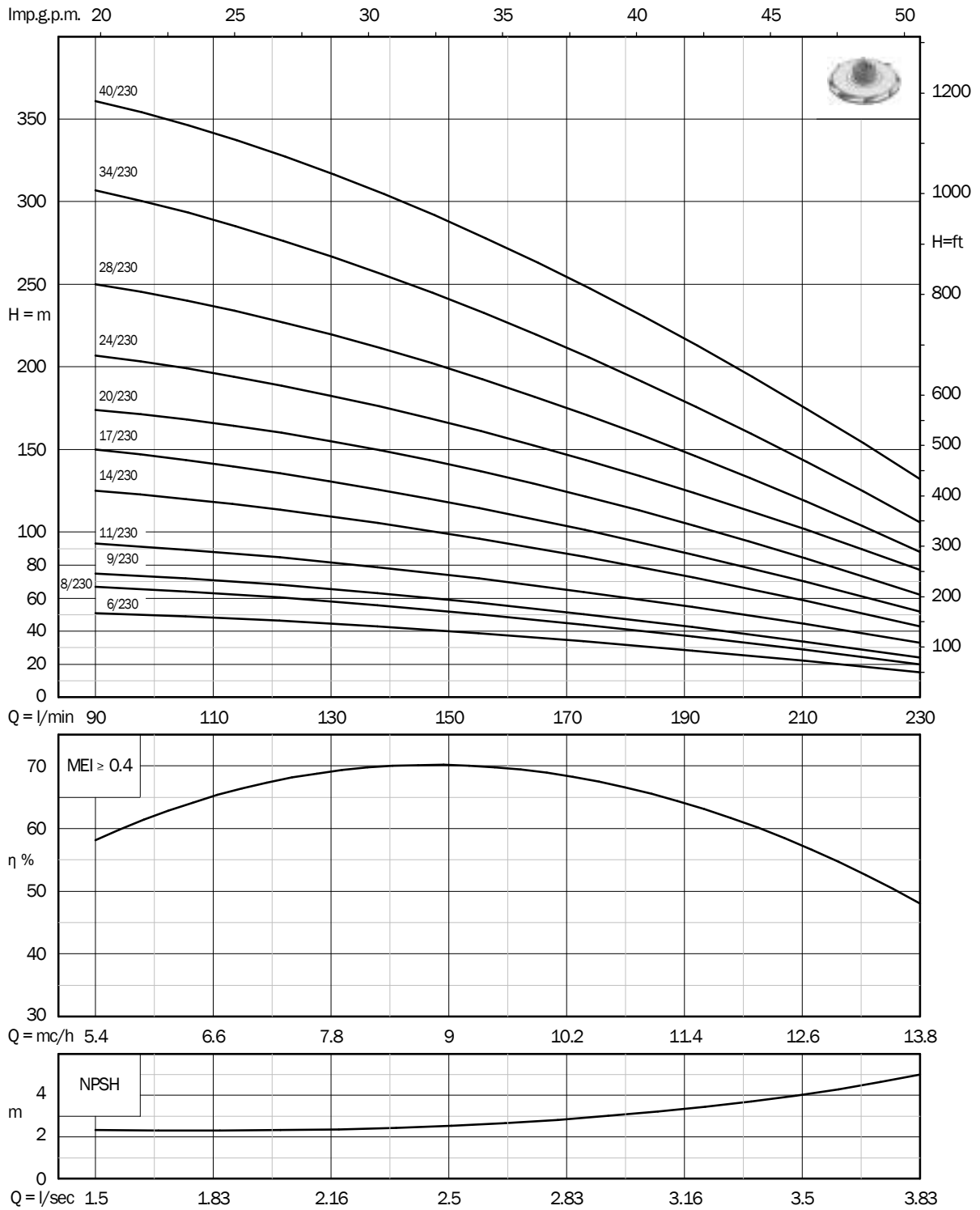

# Electric submersible pumps IDROSAND series 330

for 6" boreholes

## PERFORMANCE DATA - 2 poles 50 Hz

Radial impeller 	Pump Code	Motor Code	Version		P2		A	Flow		DNM (GAS)	Dimensions (mm)			Cable m	Weight kg
					hp	kW		l/min	m		A	B	C		
IDROSAND 4/330	P330/04	M4M20	230 V	1-phase	2	1,5	11	150 - 250 - 330	34 - 24 - 11	2"	1070	456	146	2	28,9
		M4T20	400 V	3-phase			4,2				1020	406	146		
IDROSAND 5/330	P330/05	M4M30/2	230 V	1-phase	3	2,2	15,7	150 - 250 - 330	42 - 29 - 14	2"	1156	506	146	2	31,4
		M4T30	400 V	3-phase			5,7				1106	456	146		
IDROSAND 6/330	P330/06	M4M30/2	230 V	1-phase	3	2,2	15,7	150 - 250 - 330	48 - 34 - 16	2"	1192	506	146	2	35,4
		M4T30	400 V	3-phase			5,7				1142	456	146		
IDROSAND 7/330	P330/07	M4T40	400 V	3-phase	4	3	8	150 - 250 - 330	57 - 41 - 20	2"	1253	531	146	2	33,9
IDROSAND 9/330	P330/09	M4T55	400 V	3-phase	5,5	4	10	150 - 250 - 330	74 - 50 - 24	2"	1381	587	146	2	38,8
IDROSAND 10/330	P330/10	M4T55	400 V	3-phase	5,5	4	10	150 - 250 - 330	86 - 60 - 29	2"	1417	587	146	2	39,2
IDROSAND 12/330	P330/12	M6TA75/2	400 V	3-phase	7,5	5,5	12,8	150 - 250 - 330	101 - 69 - 33	2"	1574	672	146	3	62
IDROSAND 14/330	P330/14	M6TA75/2	400 V	3-phase	7,5	5,5	12,8	150 - 250 - 330	116 - 80 - 37	2"	1646	672	146	3	63,1
IDROSAND 16/330	P330/16	M6TA10/2	400 V	3-phase	10	7,5	17	150 - 250 - 330	134 - 94 - 46	2"	1743	697	146	3	67,2
IDROSAND 19/330	P330/19	M6TA10/2	400 V	3-phase	10	7,5	17	150 - 250 - 330	160 - 113 - 56	2"	1851	697	146	3	68,5
IDROSAND 23/330	P330/23	M6TA125/2	400 V	3-phase	12,5	9,2	21,5	150 - 250 - 330	198 - 143 - 72	2"	2020	722	146	3	75,5
IDROSAND 28/330	P330/28	M6TA15/2	400 V	3-phase	15	11	24,8	150 - 250 - 330	247 - 179 - 93	2"	2240	762	146	3	82,1
IDROSAND 32/330	P330/32	M6TA20/2	400 V	3-phase	20	15	30,7	150 - 250 - 330	285 - 205 - 108	2"	2551	857	146	3	96,9
IDROSAND 36/330	P330/36	M6TA20/2	400 V	3-phase	20	15	30,7	150 - 250 - 330	323 - 233 - 123	2"	2695	857	146	3	101
IDROSAND 43/330	P330/43	M6TA25/2	400 V	3-phase	25	18,5	39,6	150 - 250 - 330	383 - 276 - 145	2"	2987	897	146	3	110,6

Electric pumps supplied with 4" 'S' series motors up to 4 kW



### SUPPLIED WITH

Capacitor (single-phase versions)



### OPTIONS

Pump end with two cables

Version for star-delta motors 400/690 V (for 6" motors)

Version with brass motor body (for 6" motors)



**PERFORMANCE CURVES - 2 poles 50 Hz**

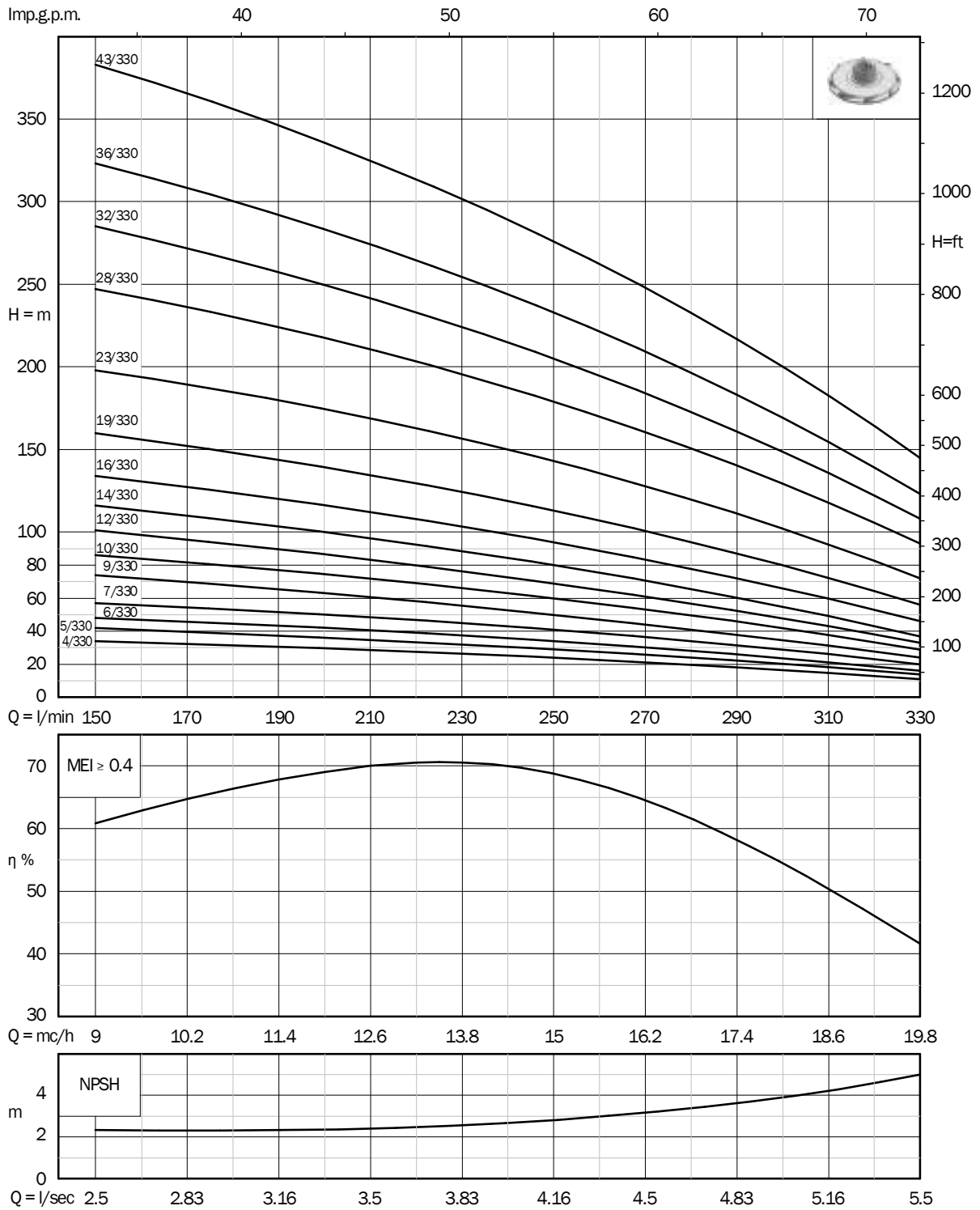



# Electric submersible pumps IDROSAND+ series 400

for 6" boreholes

## PERFORMANCE DATA - 2 poles 50 Hz

Radial impeller 	Pump Code	Motor Code	Version		P2		A	Flow		DNM (GAS)	Dimensions (mm)			Cable m	Weight kg
					hp	kW		l/min	m		A	B	C		
IDROSAND+ 4/400	P400/04	M4T40	400 V	3-phase	4	3	8	170 - 300 - 450	42 - 31 - 14	3"	1136	531	146	2	37
IDROSAND+ 5/400	P400/05	M4T55	400 V	3-phase	5,5	4	10	170 - 300 - 450	53 - 42 - 20	3"	1242	587	146	2	42,4
IDROSAND+ 6/400	P400/06	M4T55	400 V	3-phase	5,5	4	10	170 - 300 - 450	65 - 50 - 25	3"	1292	587	146	2	43,8
IDROSAND+ 7/400	P400/07	M6TA75/2	400 V	3-phase	7,5	5,5	12,8	170 - 300 - 450	76 - 59 - 29	3"	1427	672	146	3	66,5
IDROSAND+ 8/400	P400/08	M6TA10/2	400 V	3-phase	10	7,5	17	170 - 300 - 450	88 - 69 - 34	3"	1502	697	146	3	71
IDROSAND+ 10/400	P400/10	M6TA10/2	400 V	3-phase	10	7,5	17	170 - 300 - 450	110 - 86 - 42	3"	1602	697	146	3	74,1
IDROSAND+ 12/400	P400/12	M6TA125/2	400 V	3-phase	12,5	9,2	21,5	170 - 300 - 450	130 - 102 - 50	3"	1727	722	146	3	80
IDROSAND+ 15/400	P400/15	M6TA15/2	400 V	3-phase	15	11	24,8	170 - 300 - 450	160 - 126 - 63	3"	1917	762	146	3	89,1
IDROSAND+ 20/400	P400/20	M6TA20/2	400 V	3-phase	20	15	30,7	170 - 300 - 450	215 - 170 - 84	3"	2262	857	146	3	111,3
IDROSAND+ 25/400	P400/25	M6TA25/2	400 V	3-phase	25	18,5	39,6	170 - 300 - 450	268 - 210 - 104	3"	2552	897	146	3	123,1

Electric pumps supplied with 4" 'S' series motors up to 4 kW



### OPTIONS

Pump end with two cables

Version for star-delta motors 400/690 V (for 6" motors)

Version with brass motor body (for 6" motors)



**PERFORMANCE CURVES - 2 poles 50 Hz**

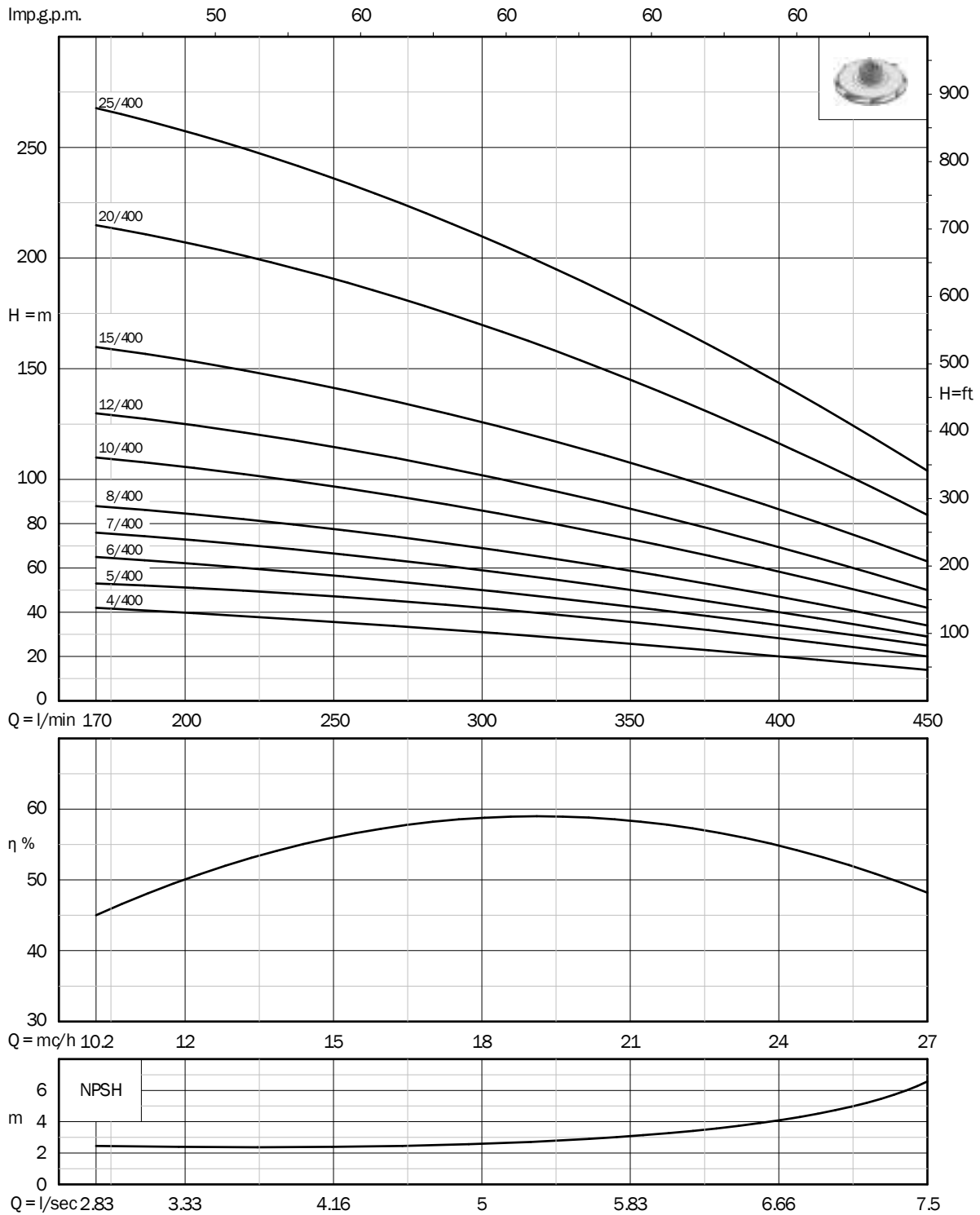

# Electric submersible pumps IDROSAND series 530

for 6" boreholes

## PERFORMANCE DATA - 2 poles 50 Hz

Radial impeller 	Pump Code	Motor Code	Version		P2		A	Flow		DNM (GAS)	Dimensions (mm)			Cable m	Weight kg
					hp	kW		l/min	m		A	B	C		
IDROSAND 4/530	P530/04	M4T40	400 V	3-phase	4	3	8	200 - 330 - 550	36 - 32 - 10	3"	1220	531	146	2	33,7
IDROSAND 6/530	P530/06	M4T55	400 V	3-phase	5,5	4	10	200 - 330 - 550	53 - 48 - 16	3"	1376	587	146	2	38,5
IDROSAND 8/530	P530/08	M6TA75/2	400 V	3-phase	7,5	5,5	12,8	200 - 330 - 550	70 - 64 - 21	3"	1579	672	146	3	61,2
IDROSAND 11/530	P530/11	M6TA10/2	400 V	3-phase	10	7,5	17	200 - 330 - 550	97 - 87 - 29	3"	1736	697	146	3	66,4
IDROSAND 14/530	P530/14	M6TA125/2	400 V	3-phase	12,5	9,2	21,5	200 - 330 - 550	123 - 111 - 37	3"	1911	722	146	3	71,3
IDROSAND 17/530	P530/17	M6TA15/2	400 V	3-phase	15	11	24,8	200 - 330 - 550	149 - 135 - 45	3"	2101	762	146	3	78,2
IDROSAND 22/530	P530/22	M6TA20/2	400 V	3-phase	20	15	30,7	200 - 330 - 550	193 - 175 - 59	3"	2446	857	146	3	94,3
IDROSAND 28/530	P530/28	M6TA25/2	400 V	3-phase	25	18,5	39,6	200 - 330 - 550	246 - 223 - 75	3"	2858	897	146	3	104,4
IDROSAND 33/530	P530/33	M6TA30/2	400 V	3-phase	30	22	46	200 - 330 - 550	290 - 263 - 88	3"	3208	997	146	3	119,7

Electric pumps supplied with 4" 'S' series motors up to 4 kW



### OPTIONS

Pump end with two cables

Version for star-delta motors 400/690 V (for 6" motors)

Version with brass motor body (for 6" motors)

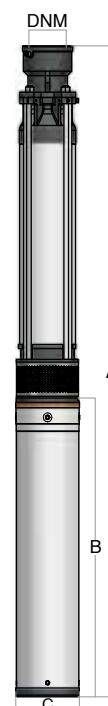

**PERFORMANCE CURVES - 2 poles 50 Hz**

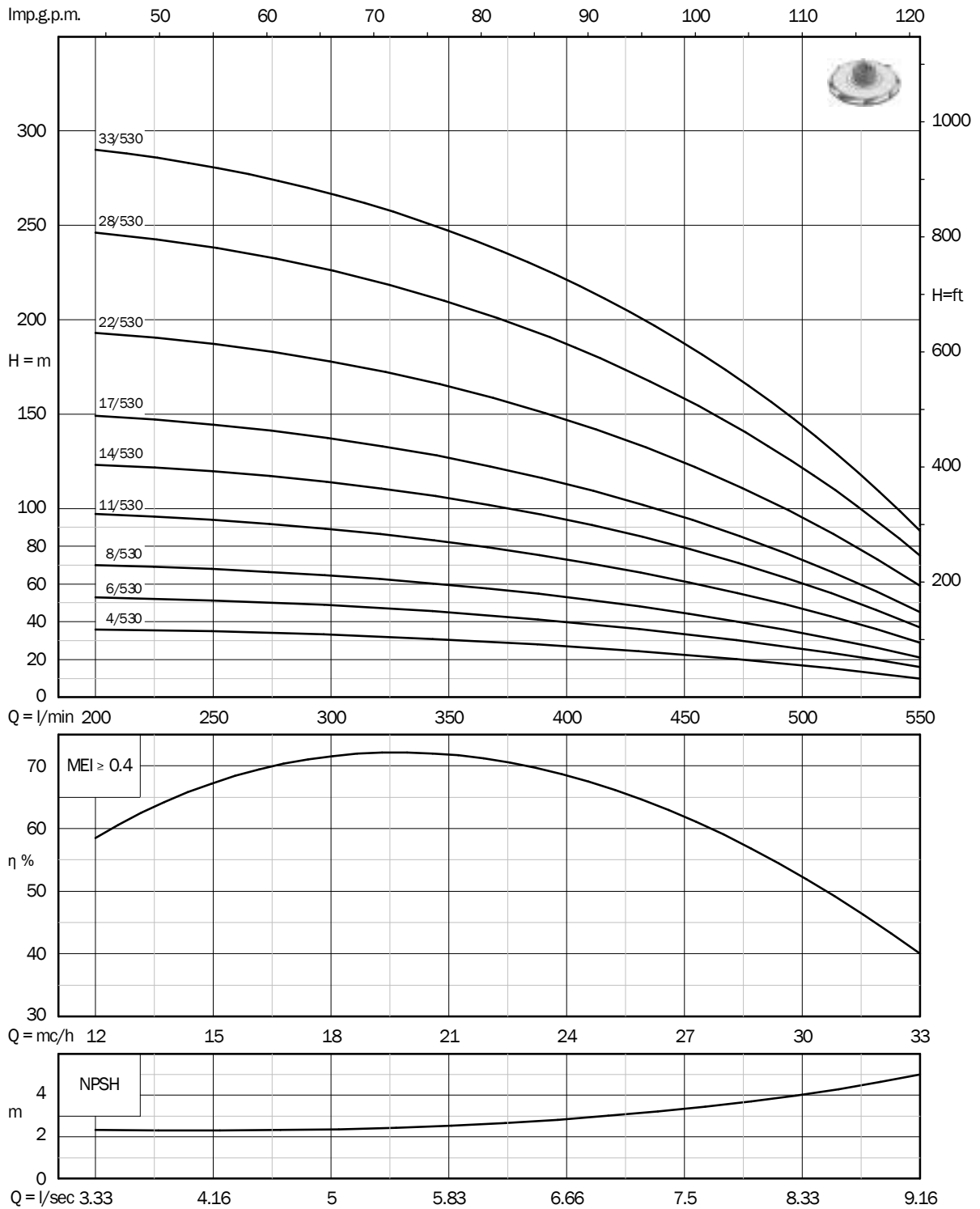

# Electric submersible pumps IDROSAND+ series 700

for 6" boreholes

## PERFORMANCE DATA - 2 poles 50 Hz

Semi-axial impeller 	Pump Code	Motor Code	Version		P2		A	Flow		DNM (GAS)	Dimensions (mm)			Cable m	Weight kg
					hp	kW		l/min	m		A	B	C		
IDROSAND+ 3/700	P700/03	M4T55	400 V	3-phase	5,5	4	10	350 - 500 - 700	34 - 25 - 9	3"	1312	587	146	2	38,1
IDROSAND+ 5/700	P700/05	M6TA75/2	400 V	3-phase	7,5	5,5	12,8	350 - 500 - 700	56 - 41 - 14	3"	1553	672	146	3	61,8
IDROSAND+ 6/700	P700/06	M6TA10/2	400 V	3-phase	10	7,5	17	350 - 500 - 700	65 - 48 - 17	3"	1656	697	146	3	65,7
IDROSAND+ 8/700	P700/08	M6TA125/2	400 V	3-phase	12,5	9,2	21,5	350 - 500 - 700	89 - 69 - 29	3"	1837	722	146	3	70,7
IDROSAND+ 10/700	P700/10	M6TA15/2	400 V	3-phase	15	11	24,8	350 - 500 - 700	112 - 86 - 36	3"	2033	762	146	3	77,6
IDROSAND+ 13/700	P700/13	M6TA20/2	400 V	3-phase	20	15	30,7	350 - 500 - 700	146 - 111 - 45	3"	2362	857	146	3	93,8
IDROSAND+ 16/700	P700/16	M6TA25/2	400 V	3-phase	25	18,5	39,6	350 - 500 - 700	177 - 134 - 54	3"	2636	897	146	3	101,5
IDROSAND+ 19/700	P700/19	M6TA30/2	400 V	3-phase	30	22	46	350 - 500 - 700	210 - 159 - 63	3"	2970	997	146	3	115,9

Electric pumps supplied with 4" 'S' series motors up to 4 kW



### OPTIONS

Pump end with two cables

Version for star-delta motors 400/690 V (for 6" motors)

Version with brass motor body (for 6" motors)

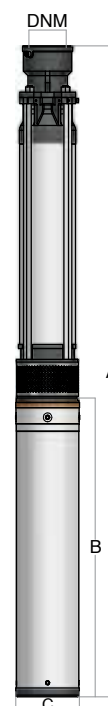



**PERFORMANCE CURVES - 2 poles 50 Hz**

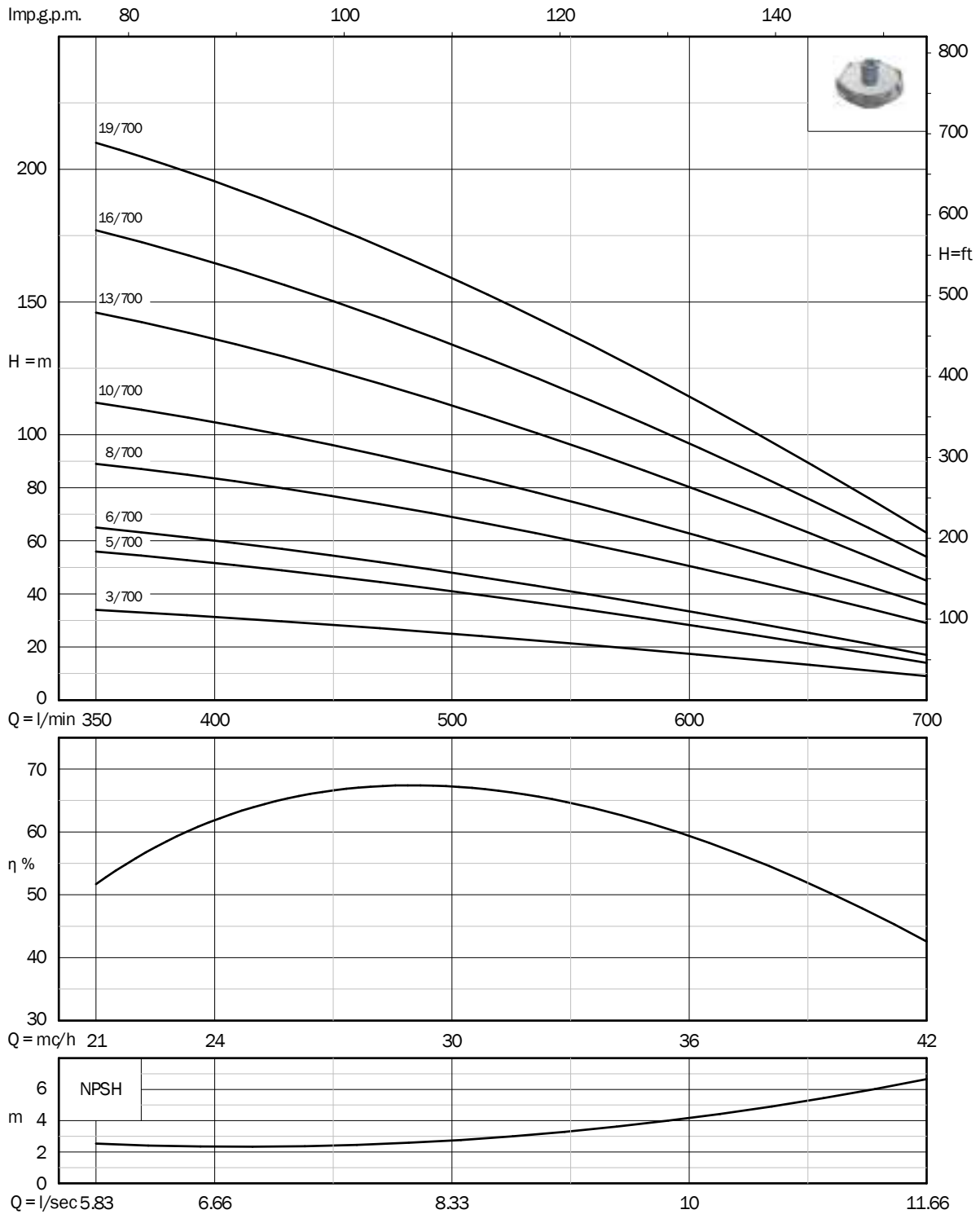

# Electric submersible pumps IDROSAND+ series 900

for 6" boreholes

## PERFORMANCE DATA - 2 poles 50 Hz

Semi-axial impeller 	Pump Code	Motor Code	Version		P2		A	Flow		DNM (GAS)	Dimensions (mm)			Cable m	Weight kg
					hp	kW		l/min	m		A	B	C		
IDROSAND+ 2/900	P900/02	M4T55	400 V	3-phase	5,5	4	10	400-650-1000	24 - 19 - 9	3"	1298	587	146	2	37,2
IDROSAND+ 3/900	P900/03	M6TA75/2	400 V	3-phase	7,5	5,5	12,8	400-650-1000	37 - 30 - 13	3"	1491	672	146	3	60,3
IDROSAND+ 4/900	P900/04	M6TA10/2	400 V	3-phase	10	7,5	17	400-650-1000	50 - 40 - 18	3"	1624	697	146	3	64,9
IDROSAND+ 5/900	P900/05	M6TA125/2	400 V	3-phase	12,5	9,2	21,5	400-650-1000	63 - 51 - 23	3"	1757	722	146	3	69,2
IDROSAND+ 6/900	P900/06	M6TA15/2	400 V	3-phase	15	11	24,8	400-650-1000	76 - 62 - 29	3"	1905	762	146	3	75,4
IDROSAND+ 8/900	P900/08	M6TA20/2	400 V	3-phase	20	15	30,7	400-650-1000	101 - 83 - 38	3"	2216	857	146	3	91,4
IDROSAND+ 10/900	P900/10	M6TA25/2	400 V	3-phase	25	18,5	39,6	400-650-1000	127 - 104 - 48	3"	2472	897	146	3	99,3
IDROSAND+ 12/900	P900/12	M6TA30/2	400 V	3-phase	30	22	46	400-650-1000	152 - 125 - 58	3"	2788	997	146	3	113,8
IDROSAND+ 15/900	P900/15	M6TA40/2	400 V	3-phase	40	30	62	400-650-1000	190 - 156 - 74	3"	3242	1127	146	3	133,4

Electric pumps supplied with 4" 'S' series motors up to 4 kW



### OPTIONS

Pump end with two cables

Version for star-delta motors 400/690 V (for 6" motors)

Version with brass motor body (for 6" motors)



**PERFORMANCE CURVES - 2 poles 50 Hz**

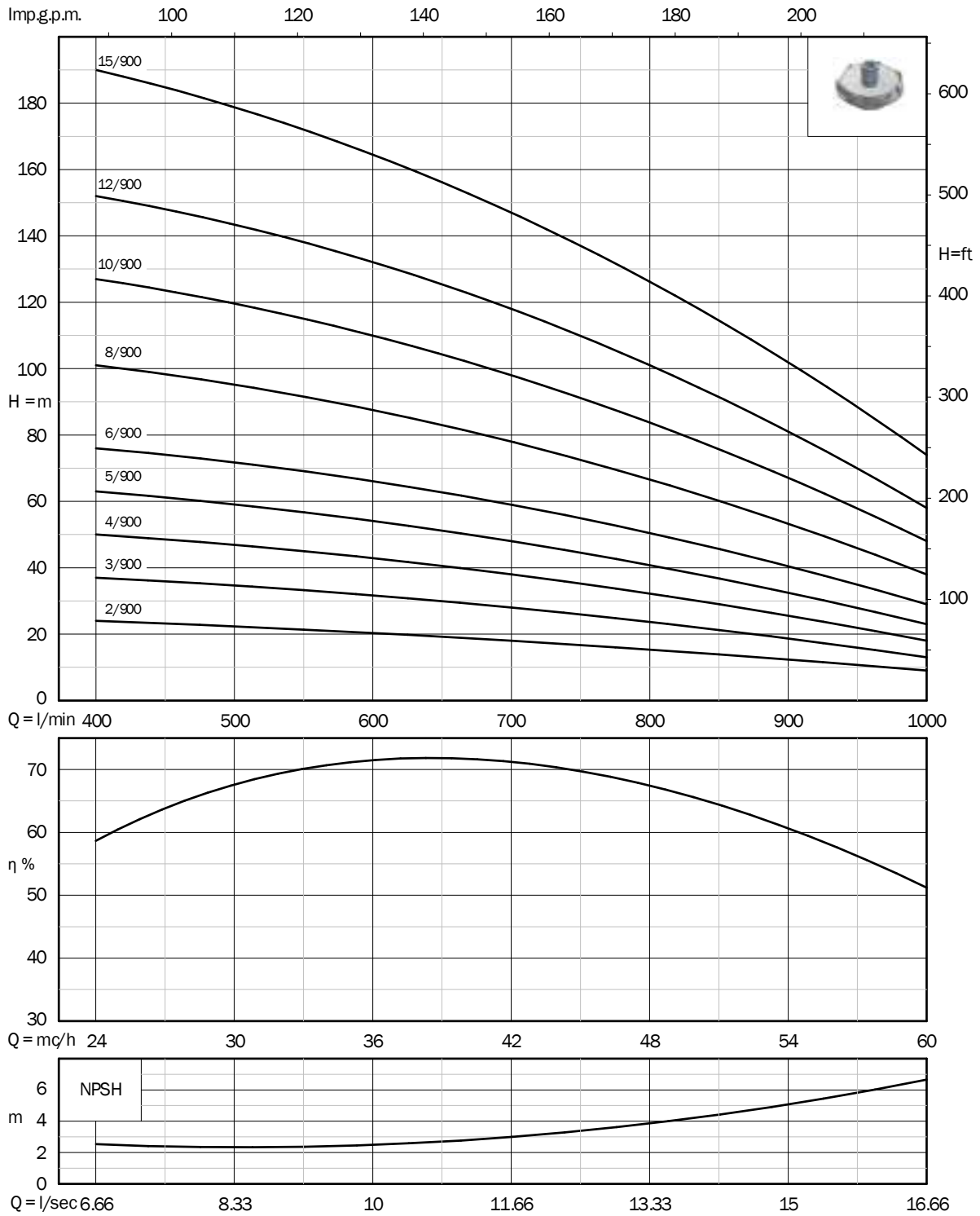

8" (200 mm)





# Electric submersible pumps

for 8" boreholes



## APPLICATION

Multistage electric submersible pumps for installations in agricultural, civil and industrial environments. Suitable to pump clean water from boreholes, tanks and reservoirs. They are recommended to pressurize water plants in block of flats, irrigation and fire-fighting systems.

## CONSTRUCTION

Water filled, asynchronous, rewindable electric AC motor with short circuit rotor. Insulation Class Y

Shafts machined on ball bearings and mechanical seals location

Both shaft and coupling meet NEMA standards

## APPLICATION RANGE

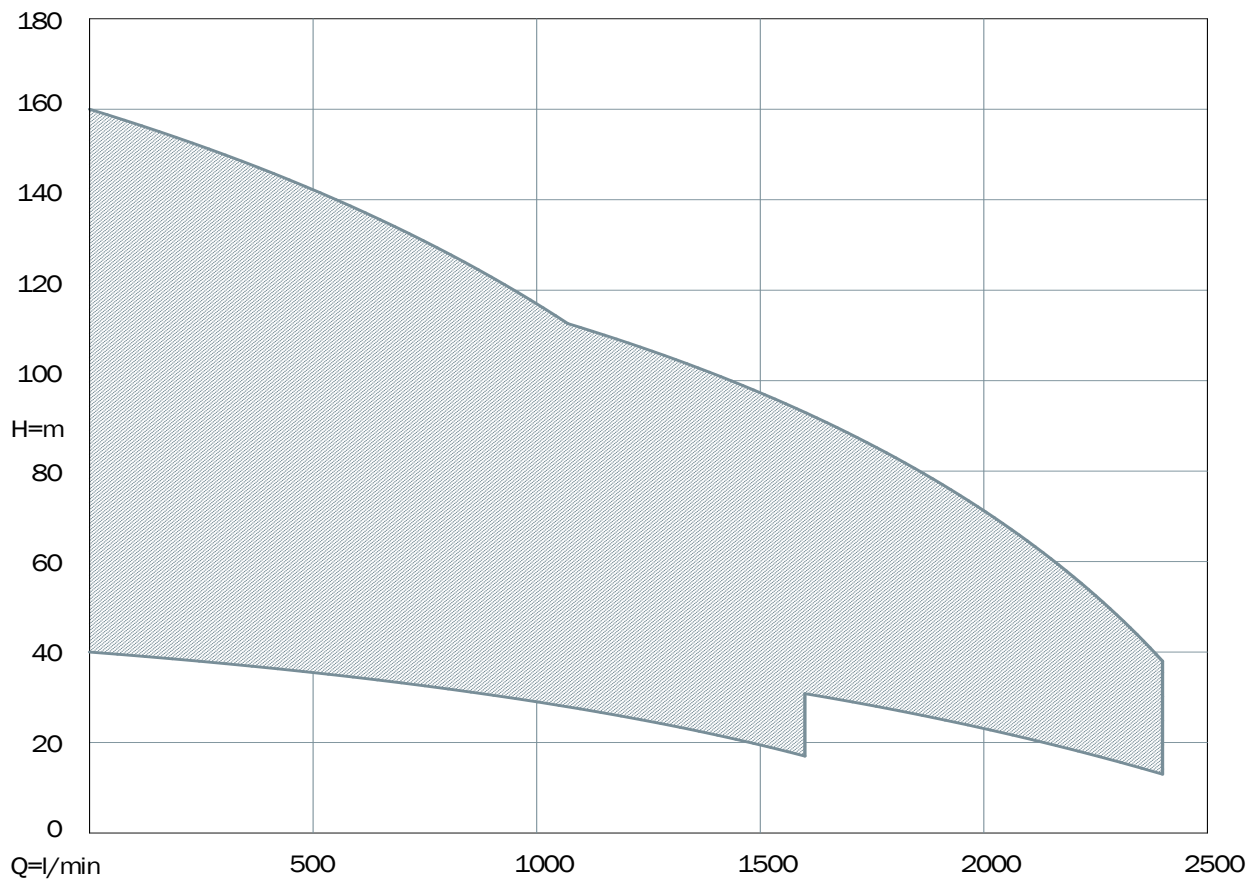



## Electric submersible pumps

for 8" boreholes

### APPLICATION FEATURES - PUMP END

	/1600	/2400
Minimum depth of the liquid to be pumped (m)	1,2	
Maximum temperature of the water to be pumped (°C)	45	
PH of the liquid pumped	6 - 10	
Maximum sand content (g/m <sup>3</sup> )	50	
Suitable to operate horizontally (included)	All	



### MATERIALS - PUMP END

	/1600	/2400
Head	Mechanical cast iron EN GJL-200	
Suction Body	Mechanical cast iron EN GJL-200	
Shaft	Stainless steel AISI410	
Coupling	Stainless steel AISI410	
Impellers	Stainless steel AISI410	
Diffusers	Mechanical cast iron EN GJL-200	
Bearings	Antifriction rubber with rotating element in Stainless Steel AISI410	
Check valve	Stainless steel AISI304	

### APPLICATION FEATURES - MOTOR

	MOTOR 6"
IP rating	IP68
Duty	Continuous S1
Maximum immersion depth (m)	200
Maximum number of starts per hour	20
Maximum temperature of the water pumped (°C)	30
PH of the liquid pumped	6 - 10
Suitable for inverter drive	All
Suitable to operate horizontally (Included)	All



### MATERIALS - MOTOR

	MOTOR 6"
Casing	Stainless Steel AISI304
Shaft Terminal	Stainless Steel AISI420B
Upper body	Mechanical cast iron with electrophoresis paint EN GJL-250 or brass OT58
Elastomers	NBR rubber
Mechanical seal	Graphite and alumina
Foot	ABS
Cable	PVC ACS AD8 (for permanent immersion in drinking water)

# Electric submersible pumps

for 8" boreholes

## PERFORMANCE DATA - PUMP ENDS - 2 poles 50 Hz

Semi-axial impeller 	P2		DNM (GAS)	Q	Flow												
	hp	kW		m <sup>3</sup> /h	0	30	48	60	72	84	96	108	120	132	144		
				l/min	0	500	800	1000	1200	1400	1600	1800	2000	2200	2400		
<b>SERIES 1600</b>																	
6TA10	2/1600	10	7,5	4"	H (m)	40	35	32	29	25	21	17					
6TA15	3/1600	15	11	4"		60	53	48	44	38	31	25					
6TA20	4/1600	20	15	4"		80	70	64	58	51	42	34					
6TA25	5/1600	25	18,5	4"		100	88	80	73	64	52	42					
6TA30	6/1600	30	22	4"		120	105	96	88	76	62	51					
6TA35	7/1600	35	26	4"		140	123	112	102	89	73	59					
6TA40	8/1600	40	30	4"		160	140	128	117	102	83	67					
<b>SERIES 2400</b>																	
6TA15	2/2400	15	11	5"	H (m)	45			39	37	34	31	27	22	18	13	
6TA25	3/2400	25	18,5	5"		68			58	56	52	47	40	33	26	19	
6TA30	4/2400	30	22	5"		90			78	74	69	62	53	44	35	26	
6TA40	5/2400	40	30	5"		113			97	93	86	78	67	55	44	32	
6TA50	6/2400	50	37	5"		135			116	111	103	93	80	66	52	38	

**PERFORMANCE DATA - MOTORS - 2 poles 50 Hz**

	Code	Voltage	Number of phases	P2		Axial load	Rotation	Nominal current	Start current	Start Torque	Efficiency %	Power factor	Size of cable	Length of cable
				hp	kW	F	$\eta_N$	$I_N$	$I_A$	$M_A$	$\eta_N$	cos $\phi$		
		V	N	min <sup>-1</sup>	A	A	Nm	mm <sup>2</sup>	m					
<b>WATER FILLED SUBMERSIBLE MOTORS for 6" boreholes</b>														
6TA55	M6TA55/2	400	3	5,5	4	8000	2900	10,6	55	34	81	0,7	4 x 4	3
6TA75	M6TA75/2	400	3	7,5	5,5	8000	2840	12,8	55	34	81	0,77	4 x 4	3
6TA10	M6TA10/2	400	3	10	7,5	8000	2830	17	73	51	80	0,79	4 x 4	3
6TA125	M6TA125/2	400	3	12,5	9,2	8000	2830	21,5	90	69	80	0,78	4 x 4	3
6TA15	M6TA15/2	400	3	15	11	8000	2850	24,8	110	80	81	0,79	4 x 4	3
6TAH15	M6TA15H/2	400	3	15	11	18000	2850	24,8	110	80	81	0,79	4 x 4	3
6TA20	M6TA20/2	400	3	20	15	18000	2880	30,7	140	63	85	0,8	4 x 4	3
6TA25	M6TA25/2	400	3	25	18,5	18000	2870	39,6	160	74	85	0,8	4 x 6	3
6TA30	M6TA30/2	400	3	30	22	18000	2900	46	180	97	86	0,8	4 x 6	3
6TA35	M6TA35/2	400	3	35	26	18000	2910	55,5	270	130	88	0,76	4 x 6	3
6TA40	M6TA40/2	400	3	40	30	18000	2900	62	270	130	87	0,8	4 x 6	3
6TA50	M6TA50/2	400	3	50	37	18000	2900	81,8	360	155	87	0,8	4 x 6	3

# Electric submersible pumps series 1600

for 8" boreholes

## PERFORMANCE DATA - 2 poles 50 Hz

Semi-axial impeller 	Pump Code	Motor Code	Version		P2		A	Flow		DNM (GAS)	Dimensions (mm)			Cable m	Weight kg
					hp	kW		l/min	m		A	B	C		
6TA10 2/1600	P1600/02	M6TA10/2	400 V	3-phase	10	7,5	17	500 - 1000 - 1600	35 - 29 - 17	4"	1357	697	196	3	82,9
6TA15 3/1600	P1600/03	M6TA15/2	400 V	3-phase	15	11	24,8	500 - 1000 - 1600	53 - 44 - 25	4"	1552	762	196	3	100,3
6TA20 4/1600	P1600/04	M6TA20/2	400 V	3-phase	20	15	30,7	500 - 1000 - 1600	70 - 58 - 34	4"	1777	857	196	3	122,2
6TA25 5/1600	P1600/05	M6TA25/2	400 V	3-phase	25	18,5	39,6	500 - 1000 - 1600	88 - 73 - 42	4"	1947	897	196	3	136,9
6TA30 6/1600	P1600/06	M6TA30/2	400 V	3-phase	30	22	46	500 - 1000 - 1600	105 - 88 - 51	4"	2177	997	196	3	158,1
6TA35 7/1600	P1600/07	M6TA35/2	400 V	3-phase	35	26	55,5	500 - 1000 - 1600	123 - 102 - 59	4"	2437	1127	196	3	182,6
6TA40 8/1600	P1600/08	M6TA40/2	400 V	3-phase	40	30	62	500 - 1000 - 1600	140 - 117 - 67	4"	2567	1127	196	3	193

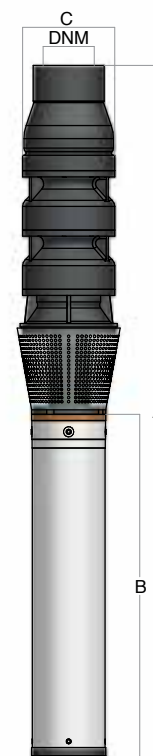

### SUPPLIED WITH

Pump end with two cables

### OPTIONS

Version for star-delta motors 400/690 V

Version with brass motor body



**PERFORMANCE CURVES - 2 poles 50 Hz**

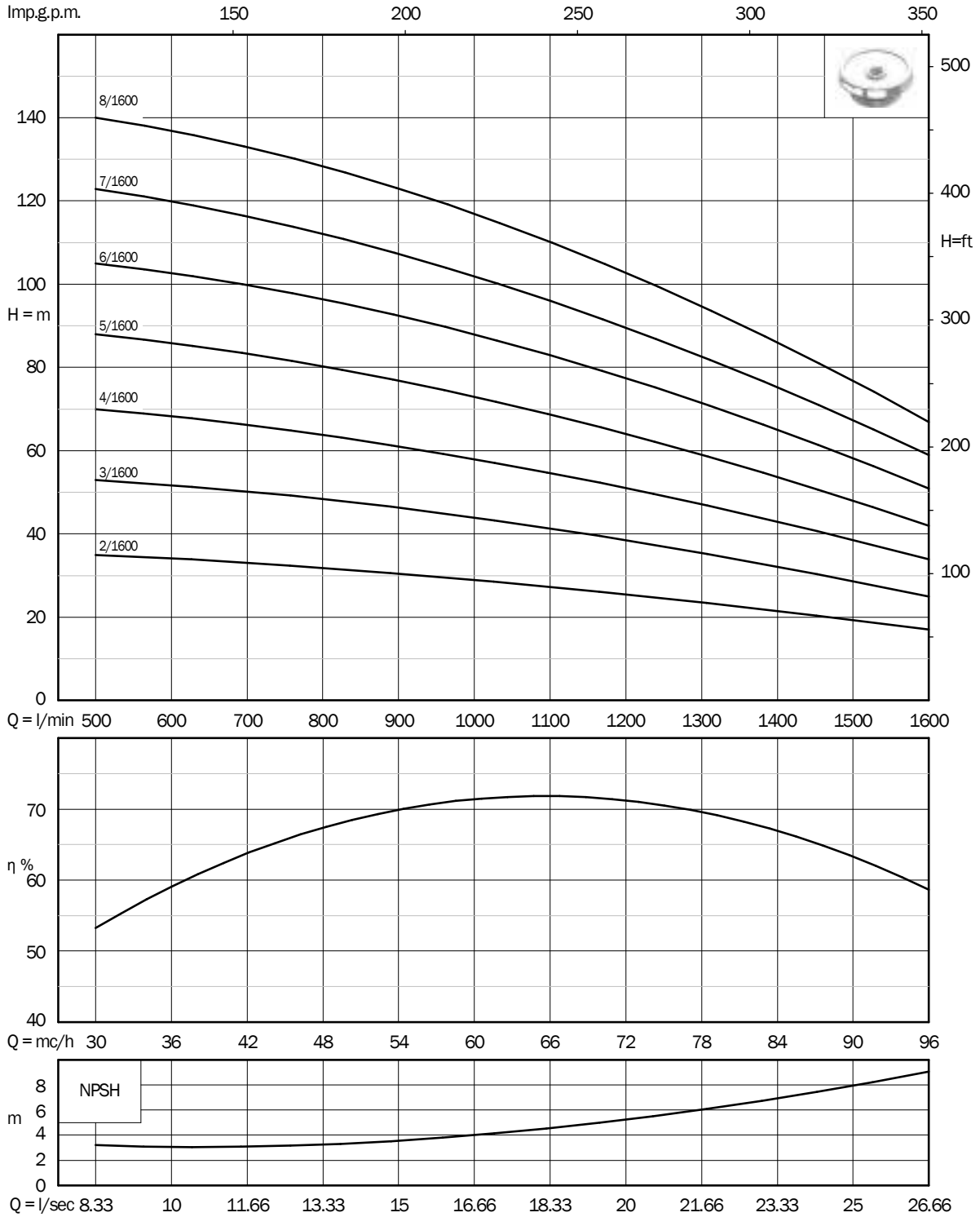

# Electric submersible pumps series 2400

for 8" boreholes

## PERFORMANCE DATA - 2 poles 50 Hz

Semi-axial impeller 	Pump Code	Motor Code	Version		P2		A	Flow		DNM (GAS)	Dimensions (mm)			Cable m	Weight kg	
					hp	kW		l/min	m		A	B	C			
6TA15	2/2400	P2400/02	M6TA15/2	400 V	3-phase	15	11	24,8	1000-1600-2400	39-31-13	5"	1425	762	196	3	91,6
6TA25	3/2400	P2400/03	M6TA25/2	400 V	3-phase	25	18,5	39,6	1000-1600-2400	58-47-19	5"	1690	897	196	3	117,7
6TA30	4/2400	P2400/04	M6TA30/2	400 V	3-phase	30	22	46	1000-1600-2400	78-62-26	5"	1920	997	196	3	138,9
6TA40	5/2400	P2400/05	M6TA40/2	400 V	3-phase	40	30	62	1000-1600-2400	97-78-32	5"	2180	1127	196	3	163,3
6TA50	6/2400	P2400/06	M6TA50/2	400 V	3-phase	50	37	81,8	1000-1600-2400	116-93-38	5"	2450	1267	196	3	188,7

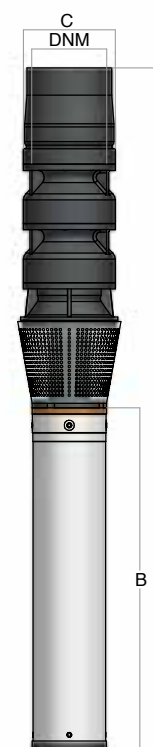

### SUPPLIED WITH

Pump end with two cables

### OPTIONS

Version for star-delta motors 400/690 V

Version with brass motor body

**PERFORMANCE CURVES - 2 poles 50 Hz**

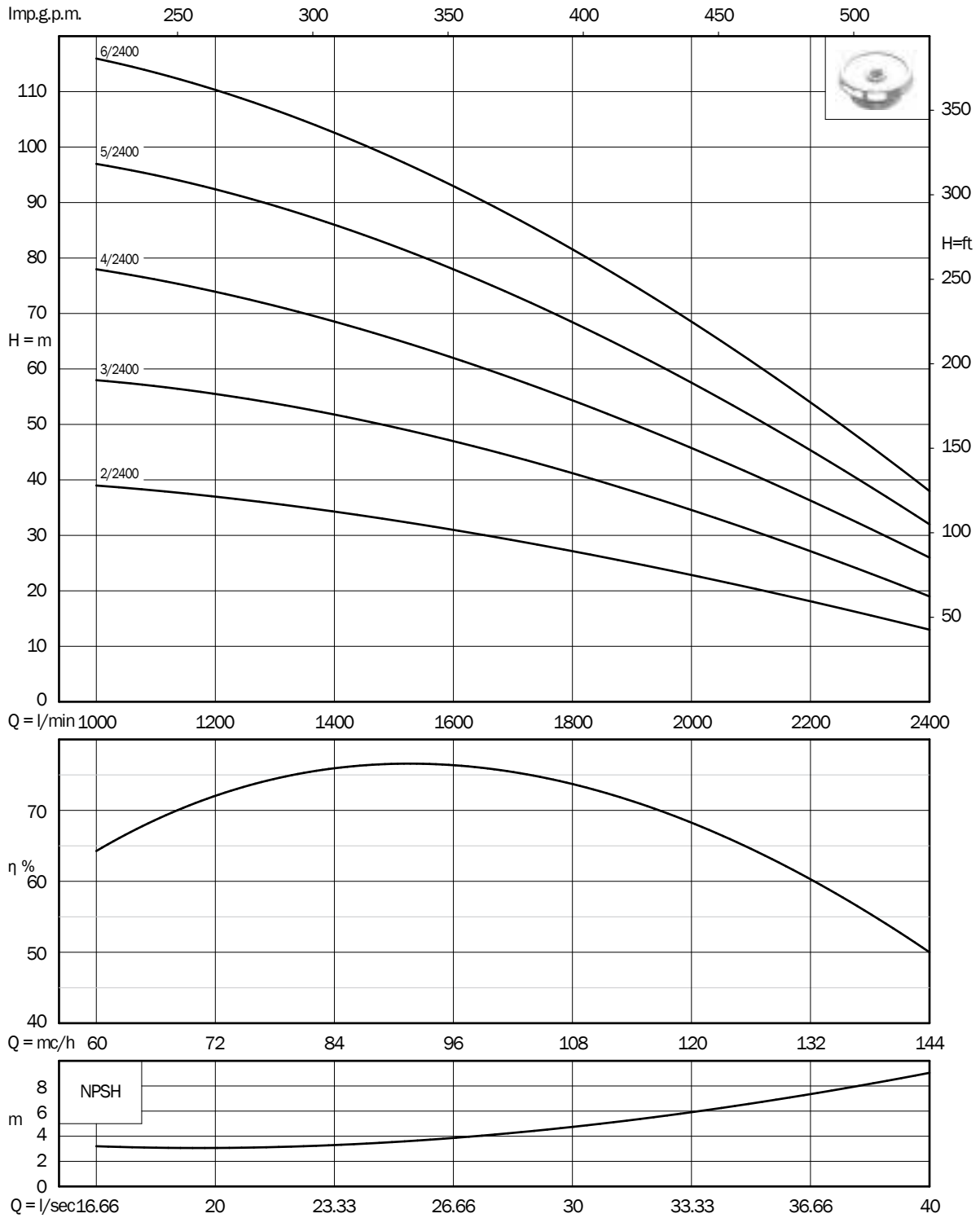



# CMO





# External electric pumps CMO

## horizontal multistage



### APPLICATION

Electric, horizontal surface pumps for installations in domestic environments.  
 Suitable to pump clean water from tanks and reservoirs.  
 They are recommended to pressurize domestic water plants and for small irrigations.

### CHARACTERISTICS

IP rating	IP55
Duty	Continuous S1
Maximum number of starts per hour	20
Maximum temperature of the liquid pumped (°C)	40
PH of the liquid pumped	6 - 10
Acoustic pressure (dB(A))	<70

### APPLICATION RANGE

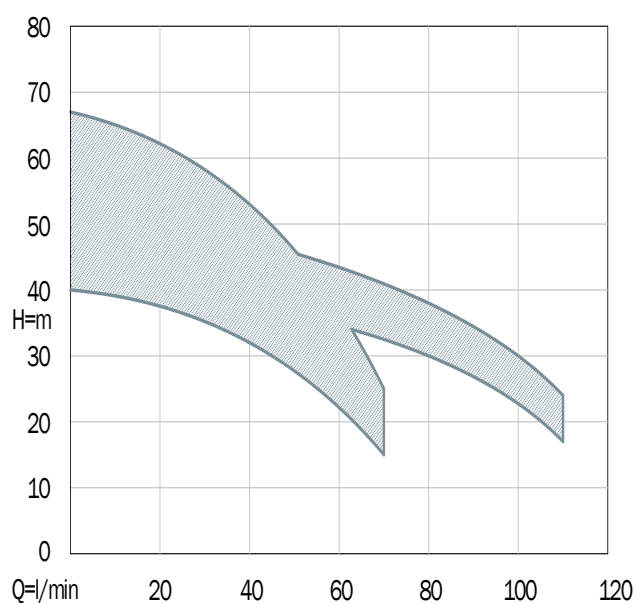

### CONSTRUCTION

Coolant filled, asynchronous, rewindable electric AC motor with short circuit rotor. Insulation Class F

External ventilation

Self priming pumps; they can prime water even when the liquid pumped is mixed with air

### MATERIALS

Suction body and discharge	Mechanical cast iron EN GJL-200
Pump casing, tie-rods, bolts and nuts	Stainless Steel AISI304
Shaft	Stainless Steel AISI420
Impellers	Stainless Steel AISI304
Diffusers	Polymer reinforced with fibre-glass
Mechanical seal	Graphite and ceramics

# External electric pumps CMO

horizontal multistage

## PERFORMANCE DATA - 2 poles 50 Hz

Radial impeller 	Code	Version	P2		A	µF	DNA (GAS)	DNM (GAS)	Q m³/h l/min	Flow							Dimensions (mm)				Weight kg
			hp	kW						0	1,2	1,8	3	4,2	5,4	6,6	A	B	C	D	
<b>SERIES 70</b>																					
CMO 3/70	EM70/030/1	230 V	1-phase	0,75	0,55	3,44	16	1"¼	H (m)	40	37	35	27	15			398	163	219	186	13
CMO 4/70	EM70/040/1	230 V	1-phase	1	0,75	4,78	20	1"¼		54	49	47	36	20			419	184	240	186	14,2
CMO 5/70	EM70/050/1	230 V	1-phase	1,25	0,92	6,12	25	1"¼		67	62	58	45	25			440	205	261	187	15,2
<b>SERIES 110</b>																					
CMO 4/110	EM110/040	230 V	1-phase	1,25	0,92	6,12	25	1"	H (m)	41		39	37	33	26	17	458	228	279	186	15,1
CMO 5/110	EM110/050	230 V	1-phase	1,5	1,1	7,08	25	1"		53		51	47	41	34	24	527	276	328	197	17

### SUPPLIED WITH

Capacitor

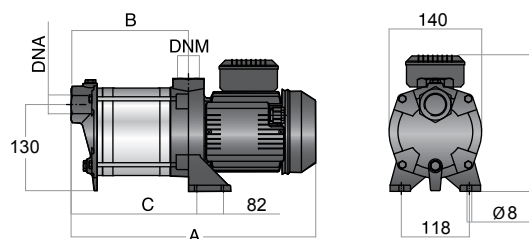



**PERFORMANCE CURVES - 2 poles 50 Hz**

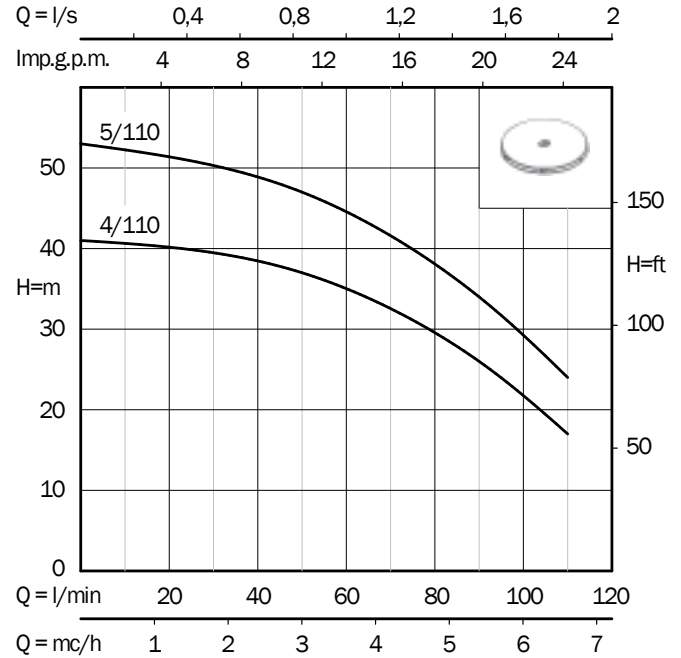
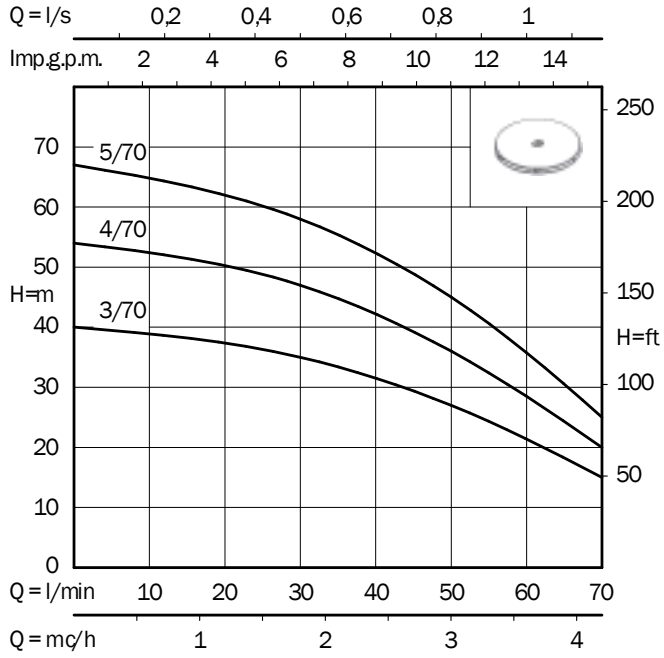

CV



# External electric pumps CV

## vertical multistage



### APPLICATION

Electric, external vertical pumps for installations in agricultural, civil and industrial environments. Suitable to pump clean water from tanks and reservoirs. They are recommended to pressurize water plants in detached houses, block of flats, irrigation and for water recirculation in conditioning plants.

### CHARACTERISTICS

IP rating	IP54
Duty	Continuous S1
Maximum number of starts per hour	20
Maximum temperature of the liquid pumped (°C)	-10 - 80
PH of the liquid pumped	6 - 10
Suitable for inverter drive	Three-phase versions only
Acoustic pressure (dB(A))	<70

### APPLICATION RANGE

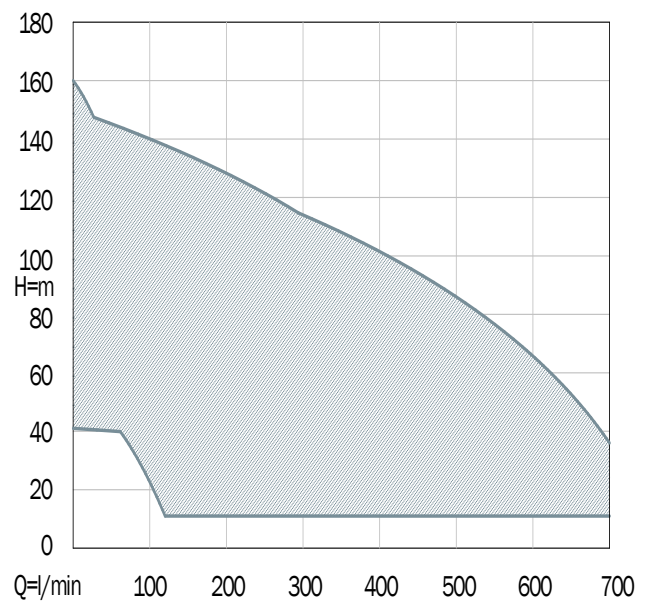

### CONSTRUCTION

Coolant filled, asynchronous, rewindable electric AC motor with short circuit rotor. Insulation Class F

400 V Motors in efficiency class IE3

External ventilation

### MATERIALS

Suction body and discharge	Mechanical Cast iron EN GJL-200
Pump casing, tie rods, bolts and nuts	Stainless Steel AISI304
Shaft	Stainless Steel AISI420B
Impellers and diffusers	Noryl® reinforced with fibre-glass, certified for drinking water and AISI304 stainless steel wear rings
Coupling	Mechanical Cast iron EN GJL-200
Guide ball bearing	Self-lubricating bronze
Mechanical seal	Graphite and Alumina
Diffuser bush	Anti fiction rubber (series 700)



# External electric pumps CV

vertical multistage

## PERFORMANCE DATA - 2 poles 50 Hz

Radial impeller 	P2		1~230 V		3~400 V	DNA (GAS) DNM (GAS)	Q	Flow															
	hp	kW	A	µF	A			m <sup>3</sup> /h	0	1,8	2,4	3	4,2	6	7,2	8,4	9,6	11,4	12,6	13,8	15,6	18	19,8
								l/min	0	30	40	50	70	100	120	140	160	190	210	230	260	300	330
<b>SERIES 110</b>																							
CV 6/110	1	0,75	5,2	20	1,9	1"½	H (m)	54	50	48	46	40	27	16									
CV 9/110	1,5	1,1	7,6	30	3,2	1"½		82	75	73	70	60	41	25									
CV 12/110	2	1,5	10,9	45	3,6	1"½		110	101	98	93	80	54	33									
CV 16/110	3	2,2	14,5	60	5,1	1"½		152	141	136	130	112	75	44									
<b>SERIES 230</b>																							
CV 5/230	1,5	1,1	7,6	30	3,2	1"½	H (m)	47			46	44	41	39	36	32	25	20	13				
CV 6/230	2	1,5	10,9	45	3,6	1"½		56			55	53	50	46	42	37	29	22	15				
CV 8/230	3	2,2	14,5	60	5,1	1"½		75			73	70	65	60	55	49	38	29	20				
CV 11/230	4	3			6	1"½		103			100	97	91	85	78	70	56	46	33				
CV 14/230	5,5	4			8,4	1"½		138			134	130	122	115	104	93	74	59	43				
<b>SERIES 330</b>																							
CV 5/330	3	2,2	14,5	60	5,1	1"½	H (m)	49					46	45	43	41	38	35	32	27	20	14	
CV 7/330	4	3			6	1"½		68					61	59	57	55	52	49	45	39	29	20	
CV 10/330	5,5	4			8,4	1"½		102					94	91	88	84	77	72	66	57	42	29	
CV 14/330	7,5	5,5			10,1	1"½		138					128	124	120	114	103	98	88	75	54	37	

**PERFORMANCE DATA - 2 poles 50 Hz**

Radial impeller 	P2		3~400 V		Q		Flow														
	hp	kW	A	DNA (GAS)	DNM (GAS)	m <sup>3</sup> /h	0	12	15	16,8	18	19,8	21,6	24	27	30	33	36	39	42	
						l/min	0	200	250	280	300	330	360	400	450	500	550	600	650	700	
<b>SERIES 530</b>																					
CV 4/530	4	3	6	2"½	2"	H (m)	43	36	35	34	33	32	30	27	22	16	10				
CV 6/530	5,5	4	8,4	2"½	2"		64	53	52	50	49	48	45	40	33	24	16				
CV 8/530	7,5	5,5	10,1	2"½	2"		86	70	68	66	65	64	61	53	43	33	21				
CV 11/530	10	7,5	14,3	2"½	2"		118	97	94	92	90	87	83	73	60	44	29				
CV 14/530	12,5	9,2	17,7	2"½	2"		150	123	119	116	114	111	106	94	76	56	37				
Semi-axial impeller 	P2		3~400 V		Q		Flow														
	hp	kW	A	DNA (GAS)	DNM (GAS)	m <sup>3</sup> /h	0	12	15	16,8	18	19,8	21,6	24	27	30	33	36	39	42	
						l/min	0	200	250	280	300	330	360	400	450	500	550	600	650	700	
<b>SERIES 700</b>																					
CV 3/700	5,5	4	8,4	2"½	2"	H (m)	41				35	34	33	31	28	25	22	18	14	9	
CV 5/700	7,5	5,5	10,1	2"½	2"		68				59	57	55	51	46	41	35	28	21	14	
CV 6/700	10	7,5	14,3	2"½	2"		84				68	66	63	59	54	48	42	34	27	17	
CV 8/700	12,5	9,2	17,7	2"½	2"		113				93	91	87	83	76	69	60	50	40	29	
CV 10/700	15	11	19,4	2"½	2"		141				116	114	110	104	96	86	75	62	50	36	



# External electric pumps CV series 110

vertical multistage

## PERFORMANCE DATA - 2 poles 50 Hz

Radial impeller 	Code	Version		P2		A	Flow		DNA (GAS)	Dimensions (mm)				Weight
				hp	kW		l/min	m	DNM (GAS)	A	B	C	D	kg
CV 6/110	EM110/06	230 V	1-phase	1	0,75	5,2	30 - 70 - 120	50 - 40 - 16	1"½	662	286	180	51	22,2
	ET110/06/2	400 V	3-phase			1,9				667				22,7
CV 9/110	EM110/09	230 V	1-phase	1,5	1,1	7,6	30 - 70 - 120	75 - 60 - 25	1"½	752	376	180	51	25,8
	ET110/09/2	400 V	3-phase			3,2				757				24,8
CV 12/110	EM110/12	230 V	1-phase	2	1,5	10,9	30 - 70 - 120	101 - 80 - 33	1"½	847	466	180	51	28,3
	ET110/12/2	400 V	3-phase			3,6								847
CV 16/110	EM110/16	230 V	1-phase	3	2,2	14,5	30 - 70 - 120	141 - 112 - 44	1"½	1033	586	180	51	34
	ET110/16/2	400 V	3-phase			5,1				1014				34,5



### SUPPLIED WITH

Capacitor (single-phase versions)



### OPTIONS

Mechanical seal: silicon carbide and alumina

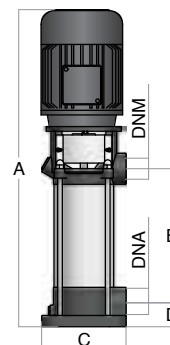
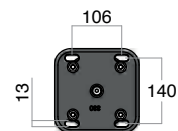

**PERFORMANCE CURVES - 2 poles 50 Hz**

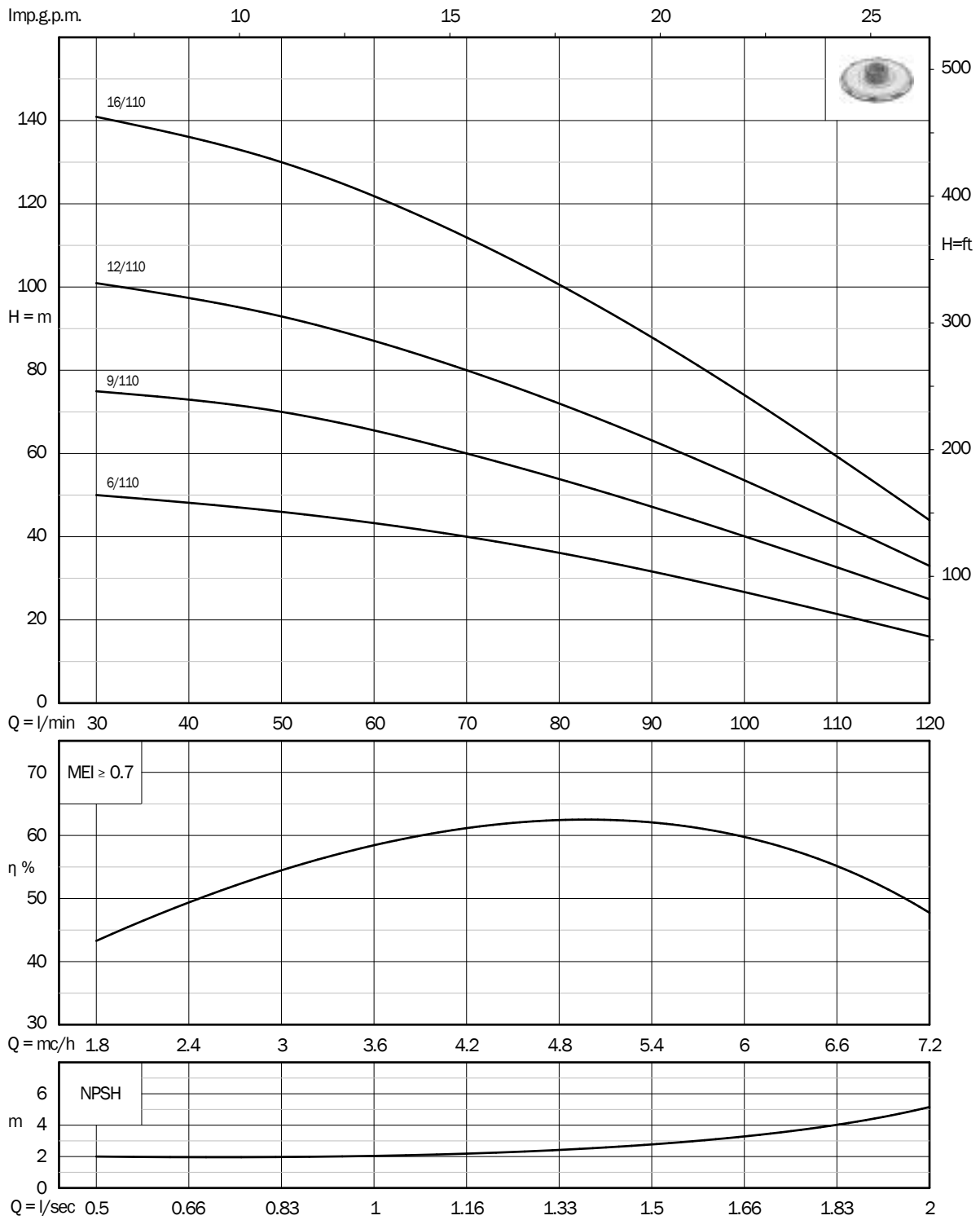

# External electric pumps CV series 230

vertical multistage

## PERFORMANCE DATA - 2 poles 50 Hz

Radial impeller 	Code	Version		P2		A	Flow		DNA (GAS)	Dimensions (mm)				Weight kg
				hp	kW		l/min	m	DNM (GAS)	A	B	C	D	
CV 5/230	EM230/05	230 V	1-phase	1,5	1,1	7,6	50 - 140 - 230	46 - 36 - 13	1"½	662	286	180	51	24,1
	ET230/05/2	400 V	3-phase			3,2				667				23,1
CV 6/230	EM230/06	230 V	1-phase	2	1,5	10,9	50 - 140 - 230	55 - 42 - 15	1"½	703	322	180	51	25,8
	ET230/06/2	400 V	3-phase			3,6								26,3
CV 8/230	EM230/08	230 V	1-phase	3	2,2	14,5	50 - 140 - 230	73 - 55 - 20	1"½	841	394	180	51	31,7
	ET230/08/2	400 V	3-phase			5,1				822				31,7
CV 11/230	ET230/11/2	400 V	3-phase	4	3	6	50 - 140 - 230	100 - 78 - 33	1"½	964	502	180	51	38
CV 14/230	ET230/14/2	400 V	3-phase	5,5	4	8,4	50 - 140 - 230	134 - 104 - 43	1"½	1074	610	180	51	44



### SUPPLIED WITH

Capacitor (single-phase versions)



### OPTIONS

Mechanical seal: silicon carbide and alumina

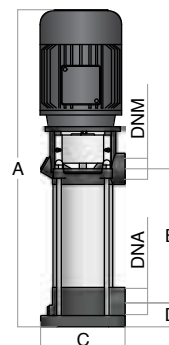
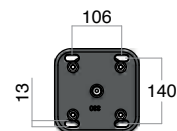

**PERFORMANCE CURVES - 2 poles 50 Hz**

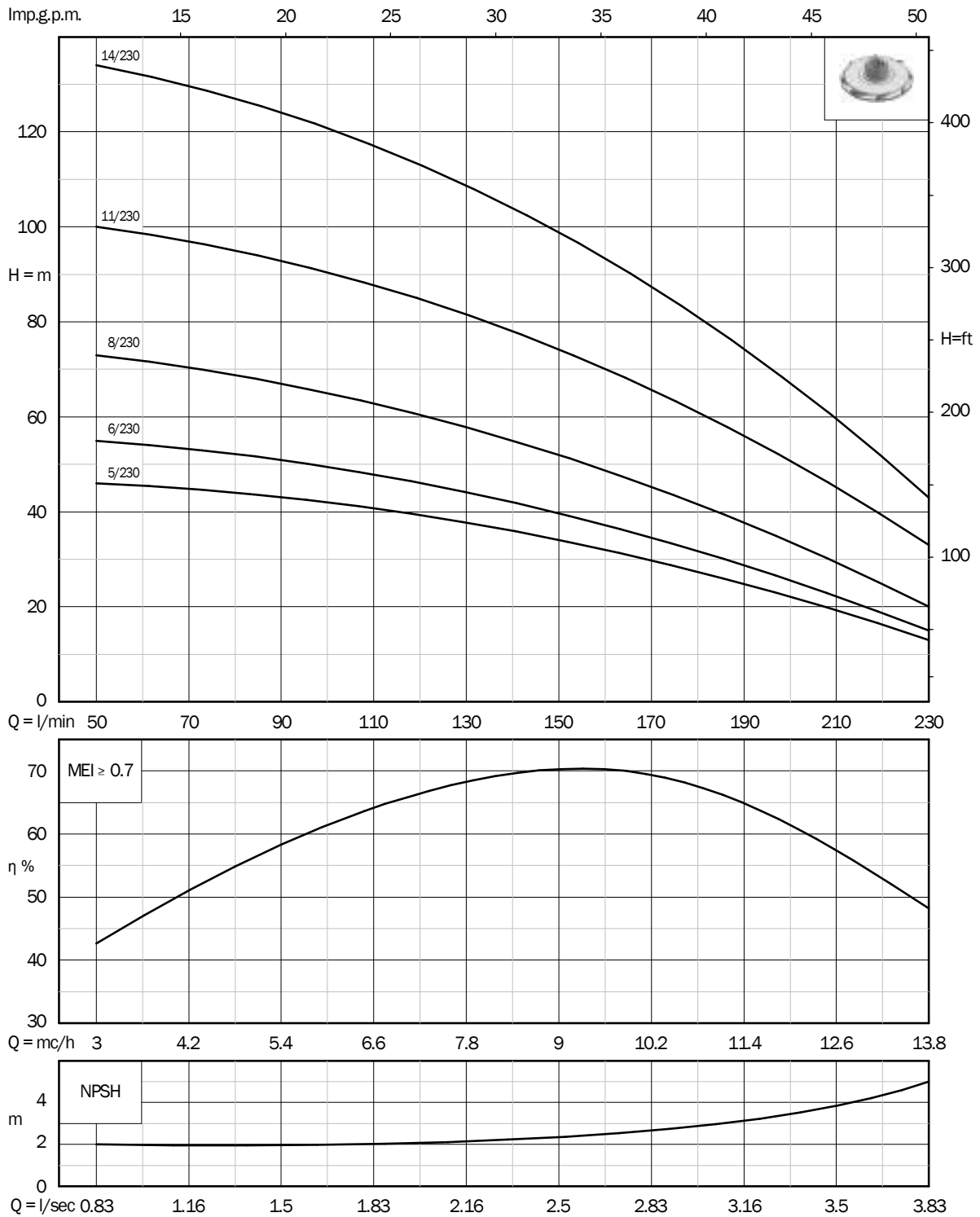

# External electric pumps CV series 330

vertical multistage

## PERFORMANCE DATA - 2 poles 50 Hz

Radial impeller 	Code	Version		P2		A	Flow		DNA (GAS)	Dimensions (mm)				Weight
				hp	kW		l/min	m	DNM (GAS)	A	B	C	D	kg
CV 5/330	EM330/05	230 V	1-phase	3	2,2	14,5	100 - 230 - 330	46 - 32 - 14	1"½	733	286	180	51	29,6
	ET330/05/2	400 V	3-phase			5,1				714				29,6
CV 7/330	ET330/07/2	400 V	3-phase	4	3	6	100 - 230 - 330	61 - 45 - 20	1"½	820	358	180	51	35,3
CV 10/330	ET330/10/2	400 V	3-phase	5,5	4	8,4	100 - 230 - 330	94 - 66 - 29	1"½	930	466	180	51	41,1
CV 14/330	ET330/14/2	400 V	3-phase	7,5	5,5	10,1	100 - 230 - 330	128 - 88 - 37	1"½	1083	610	180	51	51,5



### SUPPLIED WITH

Capacitor (single-phase versions)



### OPTIONS

Mechanical seal: silicon carbide and alumina

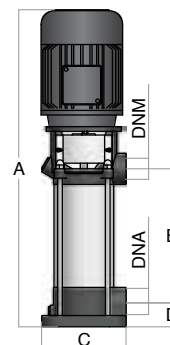
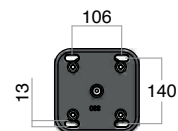



**PERFORMANCE CURVES - 2 poles 50 Hz**

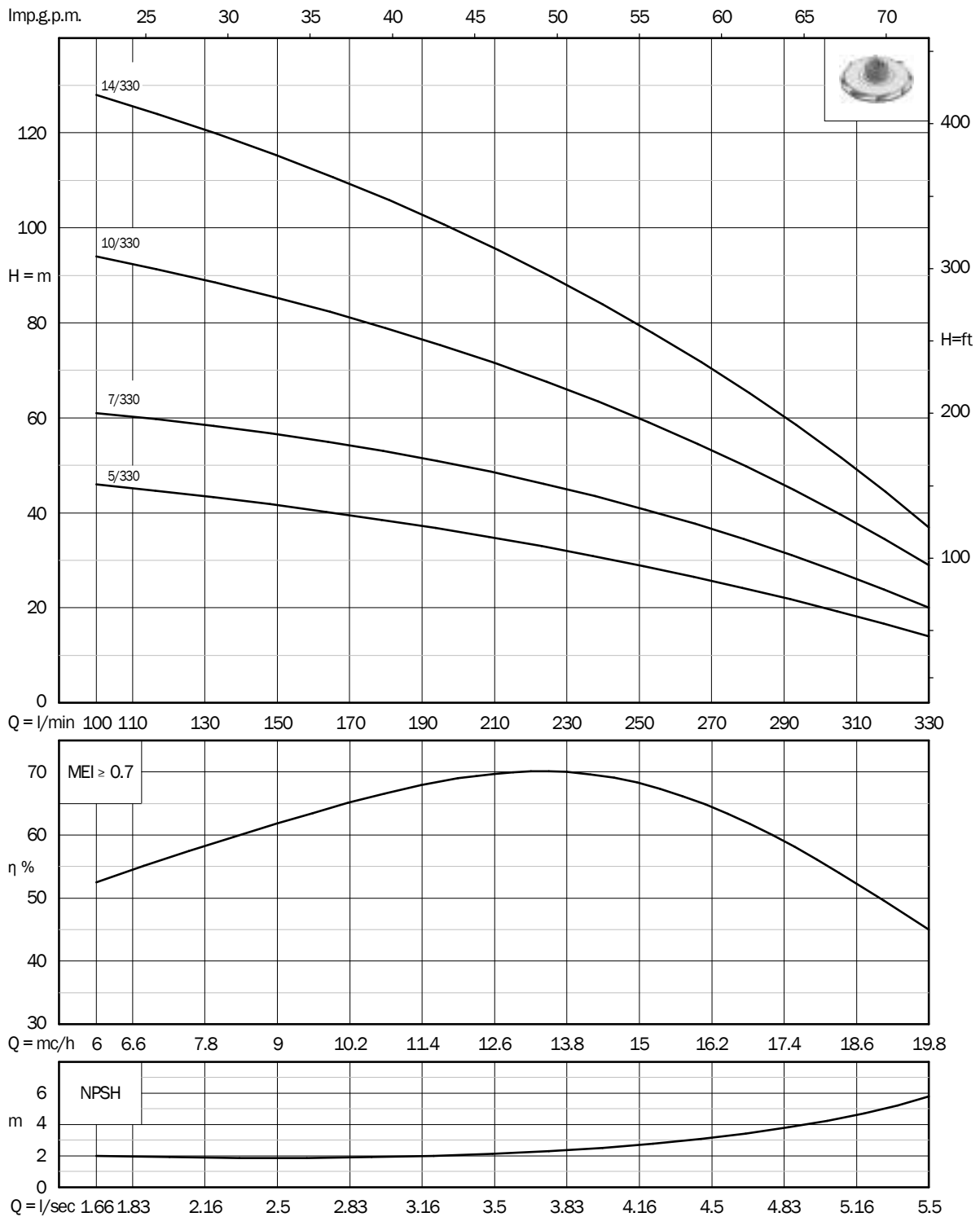

# External electric pumps CV series 530

vertical multistage

## PERFORMANCE DATA - 2 poles 50 Hz

Radial impeller 	Code	Version		P2		A	Flow		DNA (GAS)	DNM (GAS)	Dimensions (mm)				Weight kg
				hp	kW		l/min	m			A	B	C	D	
CV 4/530	ET530/04/2	400 V	3-phase	4	3	6	200 - 330 - 550	36 - 32 - 10	2"½	2"	861	327	200	68	40,2
CV 6/530	ET530/06/2	400 V	3-phase	5,5	4	8,4	200 - 330 - 550	53 - 48 - 16	2"½	2"	963	427	200	68	45,7
CV 8/530	ET530/08/2	400 V	3-phase	7,5	5,5	10,1	200 - 330 - 550	70 - 64 - 21	2"½	2"	1072	527	200	68	54,7
CV 11/530	ET530/11/2	400 V	3-phase	10	7,5	14,3	200 - 330 - 550	97 - 87 - 29	2"½	2"	1277	677	200	68	71,4
CV 14/530	ET530/14/2	400 V	3-phase	12,5	9,2	17,7	200 - 330 - 550	123 - 111 - 37	2"½	2"	1465	827	200	68	85,2



### OPTIONS

Mechanical seal: silicon carbide and alumina

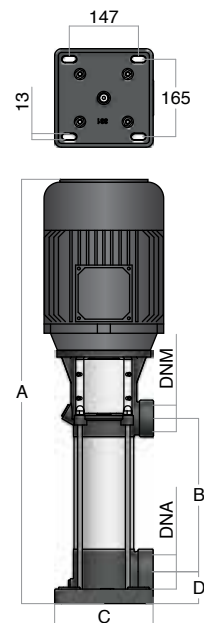

**PERFORMANCE CURVES - 2 poles 50 Hz**

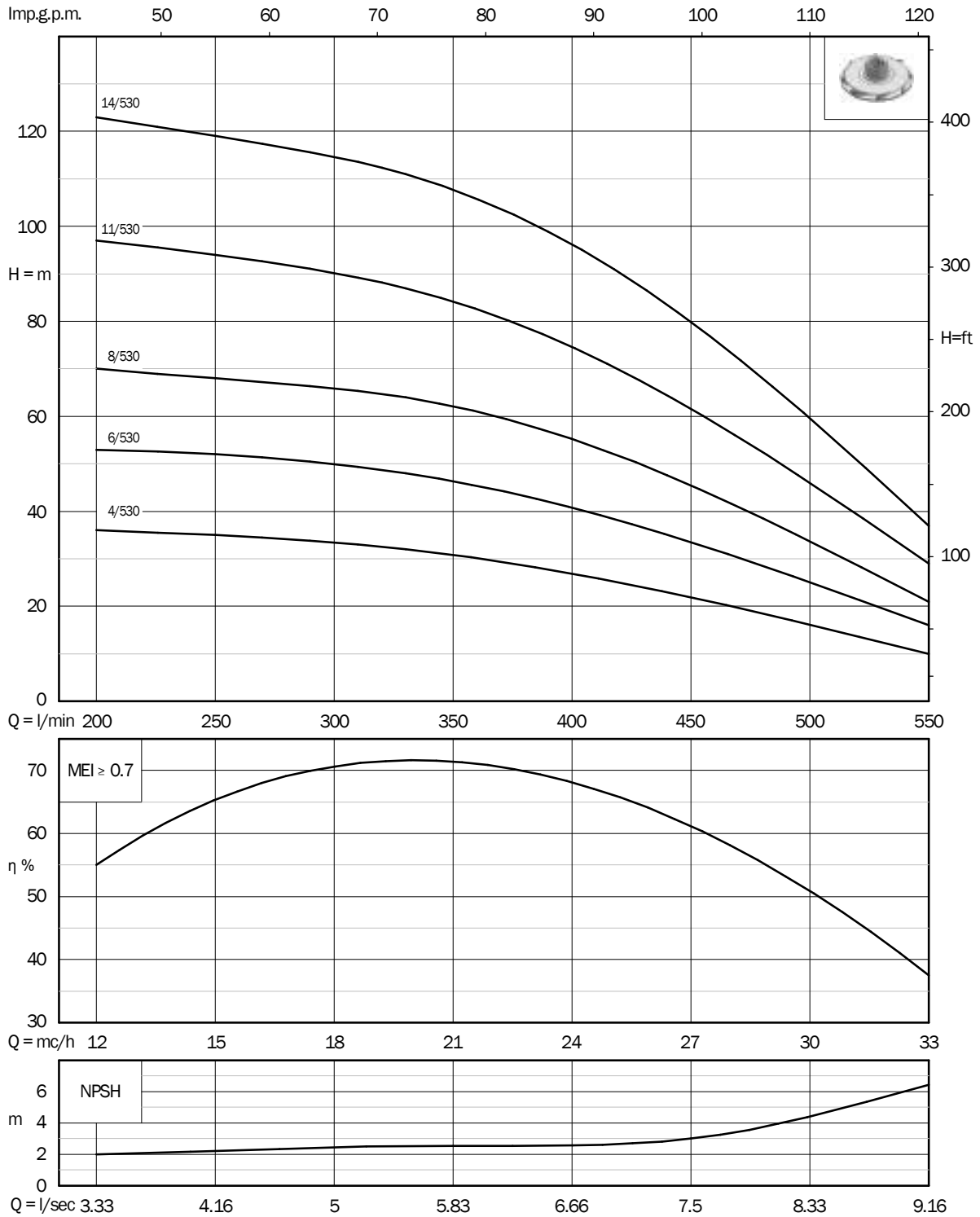

# External electric pumps CV series 700

vertical multistage

## PERFORMANCE DATA - 2 poles 50 Hz

Semi-axial impeller 	Code	Version		P2		A	Flow		DNA (GAS)	DNM (GAS)	Dimensions (mm)				Weight kg
				hp	kW		l/min	m			A	B	C	D	
CV 3/700	ET700/03/2	400 V	3-phase	5,5	4	8,4	300 - 450 - 700	35 - 28 - 9	2"½	2"	897	361	200	68	45,3
CV 5/700	ET700/05/2	400 V	3-phase	7,5	5,5	10,1	300 - 450 - 700	59 - 46 - 14	2"½	2"	1062	517	200	68	55,1
CV 6/700	ET700/06/2	400 V	3-phase	10	7,5	14,3	300 - 450 - 700	68 - 54 - 17	2"½	2"	1195	595	200	68	70,8
CV 8/700	ET700/08/2	400 V	3-phase	12,5	9,2	17,7	300 - 450 - 700	93 - 76 - 29	2"½	2"	1389	751	200	68	84,7
CV 10/700	ET700/10/2	400 V	3-phase	15	11	19,4	300 - 450 - 700	116 - 96 - 36	2"½	2"	1626	907	200	68	91,1



### OPTIONS

Mechanical seal: silicon carbide and alumina

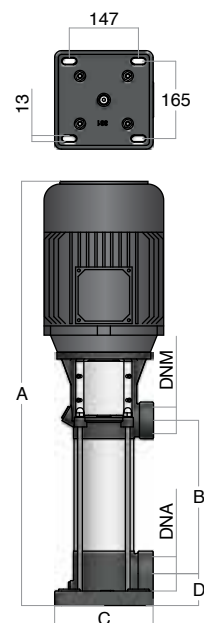

**PERFORMANCE CURVES - 2 poles 50 Hz**

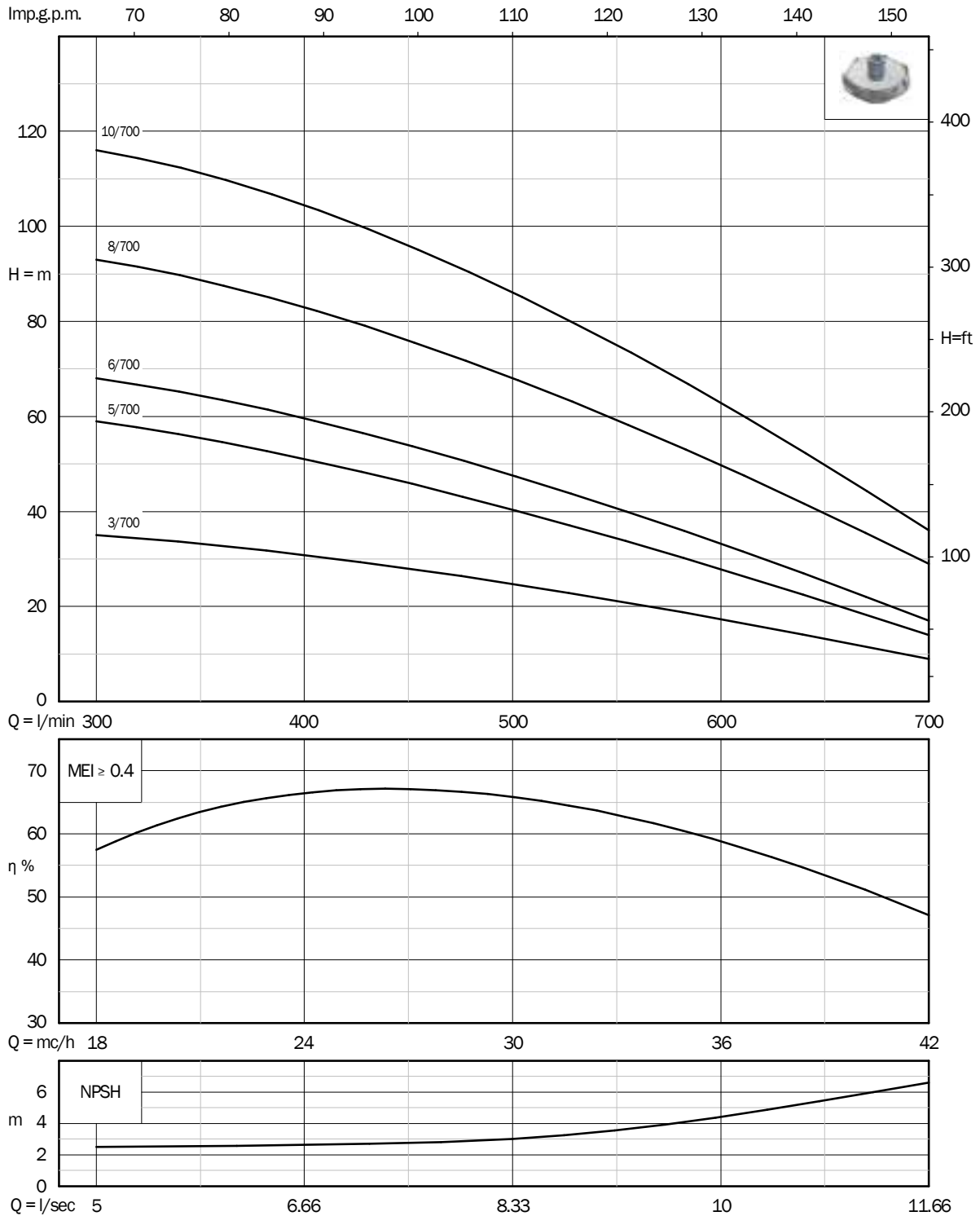

# G-CV GI-CV





## APPLICATION

Two electric pumps CV (three on request) for installations in agricultural, civil and industrial environments. Suitable to pump clean water from tanks and reservoirs. They are recommended to pressurize water plants in detached houses, block of flats, irrigation and for water recirculation in conditioning plants.

## CHARACTERISTICS

IP rating	IP54
Duty	Continuous S1
Ambient temperature (°C)	-5 - 40
Maximum number of starts per hour	20
Maximum temperature of the liquid pumped (°C)	-10 - 80
PH of the liquid pumped	6 - 10
To be installed in a sheltered place	

## APPLICATION RANGE

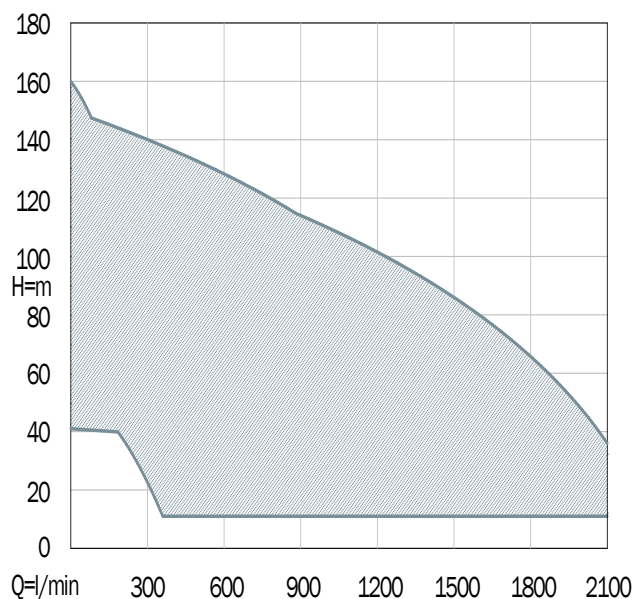

## MATERIALS

Suction body and discharge	Mechanical cast iron EN GJL-200
Pump casing, tie rods, bolt and nuts	Stainless steel AISI304
Shaft	Stainless steel AISI420B
Impellers and diffusers	Noryl® reinforced with fibre-glass, certified for drinking water and AISI304 stainless steel wear rings
Coupling	Mechanical cast iron EN GJL-200
Guide ball bearing	Self-lubricating bronze
Mechanical seal	Graphite and alumina
Diffuser bush	Anti-friction rubber (series 700)
Inlet manifold	Zinc-plated steel
Discharge manifold	Zinc-plated steel
Base and frame	Zinc-plated steel

# Automatic booster sets G-CV

## CHARACTERISTICS

	P2	Q	H
hp	kW	l/min	m
from 1 to 45	from 0,75 to 33	from 30 to 2100	from 7 to 148

## MAIN COMPONENTS

Two electric pumps CV (three on request)

N° 2 pressure switches installed on the discharge manifold to start and stop the pumps automatically (alternating - duty-assist)

Inlet manifold with non-return check valves, ball valves and facilities for air feeders

Discharge manifold connected to the electric pumps via ball valves

Pressure gauge

The whole set is assembled on one frame

Plastic control panel containing:

- opening interlocked
- hand - off - auto selector switches, one each electric pump
- electronic card that allows level control, overload protection and alternating duty - assist run of the electric pumps
- 24 V transformer 230-400
- 24 V contactors
- set of fuses for motor protection
- fuses on auxiliary circuit



## CHARACTERISTICS

P2		Q	H
hp	kW	l/min	m
from 1 to 45	from 0,75 to 33	from 30 to 2100	from 7 to 148

## MAIN COMPONENTS

Two electric pumps CV (three on request)

N° 2 pressure trasducers 4÷20 mA installed on the discharge manifold that allow the alternating duty - assist run of the electric pumps (alternating duty: equally distributed according to the actual run-time; assist: according to the request of water)

Inlet manifold with non-return check valves, ball valves and facilities for air feeders

Discharge manifold connected to the electric pumps via ball valves

Pressure gauge

The whole set is assembled on one frame

N° 2 inverters (on the top of the electric pumps) with the following characteristics:

- alarm and protection against dry running
- alarm for low and maximum pressure
- N.O or N.C, adjustable digital outputs (motor run, alarm, pump control)
- analog inputs 4÷20 mA



# Dirty water







# DOMOSOM





# Electric submersible pumps DOMOSOM

for domestic wastewater



## APPLICATIONS

Ready-to-use electric submersible pump, expressively designed for installations in domestic environments.

Suitable to expel rain or groundwater, to convey waste and sewage water coming from household appliances also containing suspended solids, whose size is up to 40 mm.

It is recommended to transfer water, to drain tanks and to move domestic sewage.

The electric pump is supplied with 10 meters power cable and Schuko plug.

## CHARACTERISTICS

IP rating	IP68
Duty	Continuous S1 (minimum immersion depth 280mm)
Maximum immersion depth (m)	7
Maximum number of starts per hour	30
Maximum temperature of the liquid pumped (°C)	35
PH of the liquid pumped	6 - 10
Density of the liquid pumped (kg/dm <sup>3</sup> )	<1,1

## APPLICATION RANGE

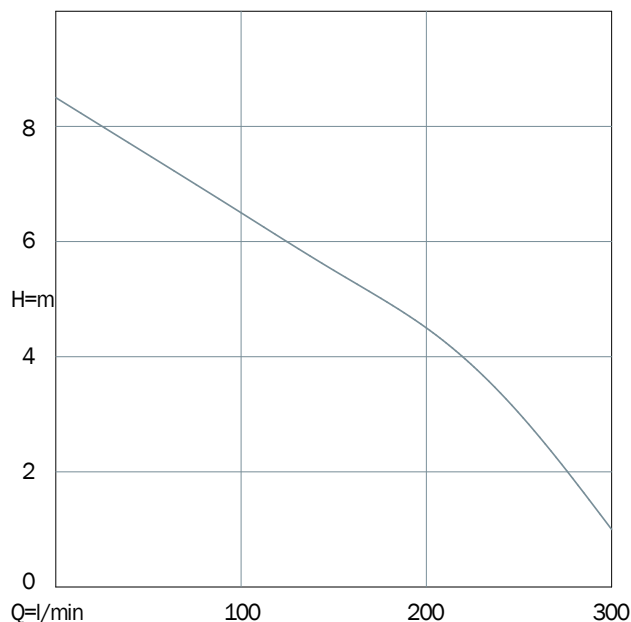

## CONSTRUCTION

AC asynchronous, rewindable electric dry motor with short circuit rotor. Insulation Class F.

Windings with phase insulators to protect the motor from power peaks, as a guarantee of a highly-trustworthy product.

Resin-insulated cable kits so to prevent penetration of water inside the motor

Shafts machined on ball bearings and mechanical seals location

Double seal with interposed oil chamber

## MATERIALS

Handle, tie-rods and motor casing	Stainless steel AISI304
Shaft	Stainless steel AISI420B
Cover and volute	Mechanical cast iron EN GJL-250
Impeller	Mechanical cast iron EN GJL-200
Mechanical Seal	Silicon carbide and alumina
Packing ring	NBR rubber
Elastomers	NBR rubber
Cable	Neoprene H07RN8-F

# Electric submersible pumps DOMOSOM

for domestic wastewater, vertical discharge

## PERFORMANCE DATA- 2 poles 50 Hz

Vortex impeller 	Code	Version		P2		Max		DNM (GAS)	Ø solid passage (mm)	Q m³/h	Flow						Dimensions (mm)				Weight kg
				hp	kW	A	µF				0	6	9	12	15	18	A	B	C	D	
<b>NEW</b> DOMOSOM 250	SM250+G	230 V	1phase + float	0,75	0,55	4,2	16	1"½	40	H (m)	8,5	6,5	5,5	4,5	3	1	400	50	230	162	14



### SUPPLIED WITH

10 meters power cable and Schuko plug



Integrated capacitor and thermal protector

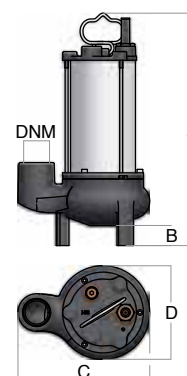

## ACCESSORIES

Code	Description
06510026	Lifting station Semibox 200 litres



**PERFORMANCE CURVES - 2 poles 50 Hz**

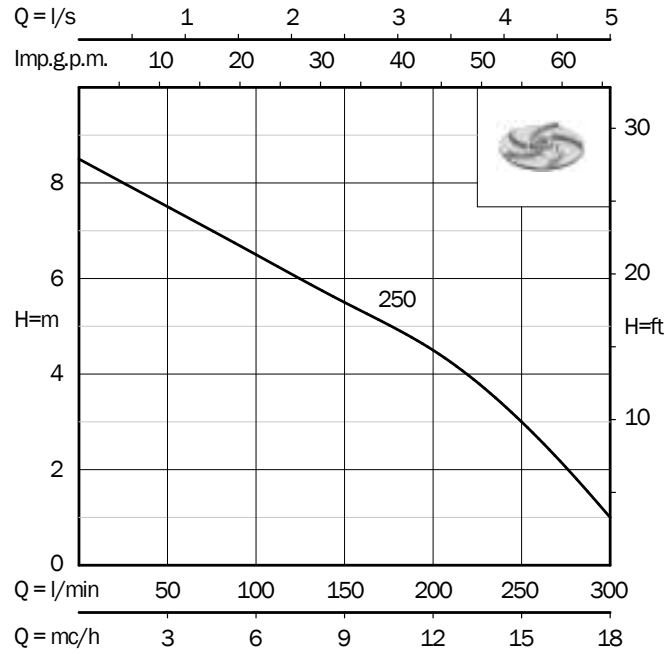

# SEMISOM

FOR GREY WATER



# Electric submersible pumps SEMISOM

for grey water



## APPLICATION

Electric submersible pumps for installations in domestic, civil and industrial environments.

Suitable to convey waste water also containing suspended solids whose size is up to 20 mm.

They are recommended to transfer water, to drain tanks or flooded spaces and to pump grey water coming from domestic, civil and industrial installations.

Some models of this range are also available in 24V DC version.

## CHARACTERISTICS

	Semisom	Seminox
IP rating	IP68	
Duty (versions 1~230V - 3~400V)	Continuous S1	
Duty (versions 24V DC)	Limited use S2 (60 minutes)	
Maximum immersion depth (m)	20	2
Maximum number of starts per hour	40	30
Maximum temperature of the liquid pumped versions 1~230V - 3~400V (°C)	50	35
Maximum temperature of the liquid pumped versions 24V DC (°C)	35	
PH of the liquid pumped	6 - 10	
Density of the liquid pumped (kg/dm <sup>3</sup> )	<1,1	
Suitable for inverter drive	Three-phase versions only	

## APPLICATION RANGE

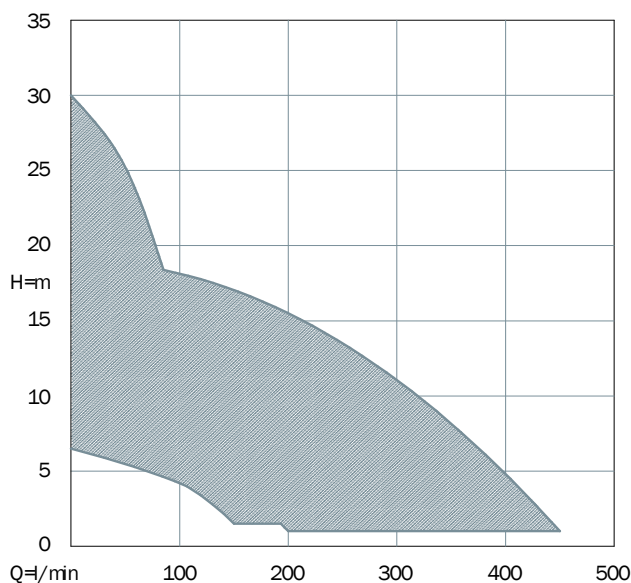

## CONSTRUCTION

1~230V - 3~400V versions: coolant filled, asynchronous, rewindable electric AC motor with short circuit rotor. Insulation Class F. Seminnox with dry motor. Windings with phase insulators to protect the motor from power peaks, as a guarantee of a highly-trustworthy product.

24V DC with permanent magnets dry electric DC motor. Insulation Class F

Resin-insulated cable kit so to prevent penetration of water inside the motor

Shafts machined on ball bearings and mechanical seals location

Double seal with interposed oil chamber

## MATERIALS

	Semisom	Seminox
Handle, tie-rods and motor casing	Stainless steel AISI304	
Shaft	Stainless steel AISI420B	Stainless steel AISI303
Cover and Volute	Mechanical cast iron EN GJL-250	Stainless steel AISI304
Tie-rods	Stainless steel AISI304	
Impeller	Mechanical cast iron EN GJL-200 (Semisom 190-130 in tecnopolymer reinforced with fibre glass)	Stainless steel AISI304 (Seminnox 155 in tecnopolymer reinforced with fibre glass)
Mechanical seal	Silicon carbide and alumina	Graphite and alumina
Seal ring	Gomma NBR	
Elastomers	NBR rubber	
Cable	Neoprene H07RN8-F; 24V DC: Twin Batt	Neoprene H07RN-F

# Electric submersible pumps SEMISOM



for grey water



## PERFORMANCE DATA

Open impeller 	P2		1~230 V		3~400 V	24 V DC	Poles	Ø solid passage (mm)	Q	Flow										
	hp	kW	Max	µF	Max	Max				m³/h	0	1,8	6	9	12	15	18	21	24	27
			A		A	A					l/min	0	30	100	150	200	250	300	350	400
SEMINOX 155	0,33	0,25	1,9	8			2	10	H (m)	7,6	6,8	4,3	1,5							
SEMINOX 155 L	0,33	0,25	2,2	8			2	20		6,5	5,9	4,2	2,4							
SEMISOM 190	0,5	0,37	2,5	10	1,2	24	2	5		10,5	9,5	7	4	1						
SEMISOM 320	0,75	0,55	4,2	16	1,7	28	2	13		11,5	11	9	7,5	5,5	3	0,5				
SEMISOM 465	1,5	1,1	7,3	20	2,7		2	5		19		17,5	16,5	15,5	14	12	9,5	6,5	1	

Open impeller 	P2		1~230 V		3~400 V	24 V DC	Poles	Ø solid passage (mm)	Q	Flow									
	hp	kW	Max	µF	Max	Max				m³/h	0	1,2	2,4	3,6	4,8	6			
			A		A	A					l/min	0	20	40	60	80	100		
SEMISOM 130	1,5	1,1	7,6	25	2,9		2	5	H (m)	30	29	26,5	23,5	19,5	15				

## AVAILABLE VERSIONS

Open impeller 	Vertical discharge 	Horizontal discharge 	Single-phase	Single-phase + Float switch	Single-phase + float and Internal capacitor	Three-phase	Three-phase + float	24 V
	SERIES							
SEMISOM 155	•				VA			
SEMISOM 155 L	•				VA			
SEMISOM 190	•		VS	VS	VA	VS		VS
SEMISOM 320	•		VS	VS	VA	VS	VA	VS
SEMISOM 465	•		VS	VS	VA	VS	VA	

Open impeller 	Vertical discharge 	Horizontal discharge 	Single-phase	Single-phase + Float switch	Single-phase + float and Internal capacitor	Three-phase	Three-phase + float	24 V
	SERIES							
SEMISOM 130		•	HS	HS		HS		

V = Vertical discharge; H = Horizontal discharge  
S = Standard version; A = Automatic version



## PERFORMANCE CURVES

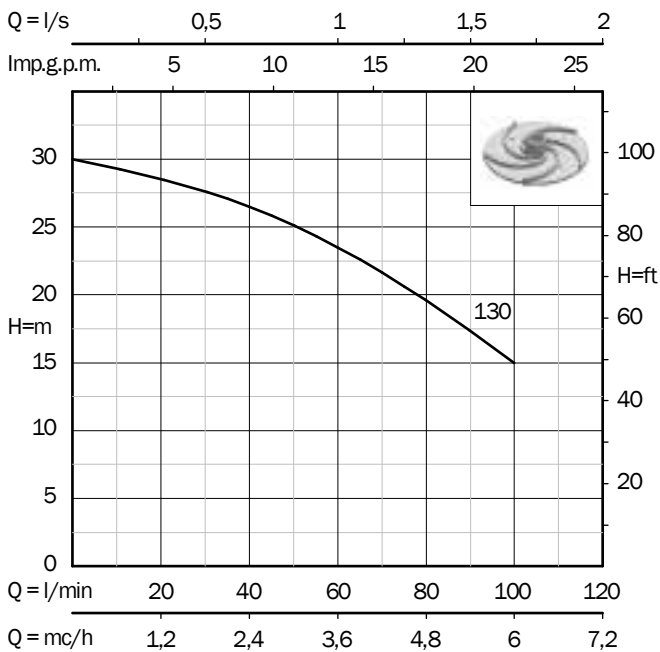
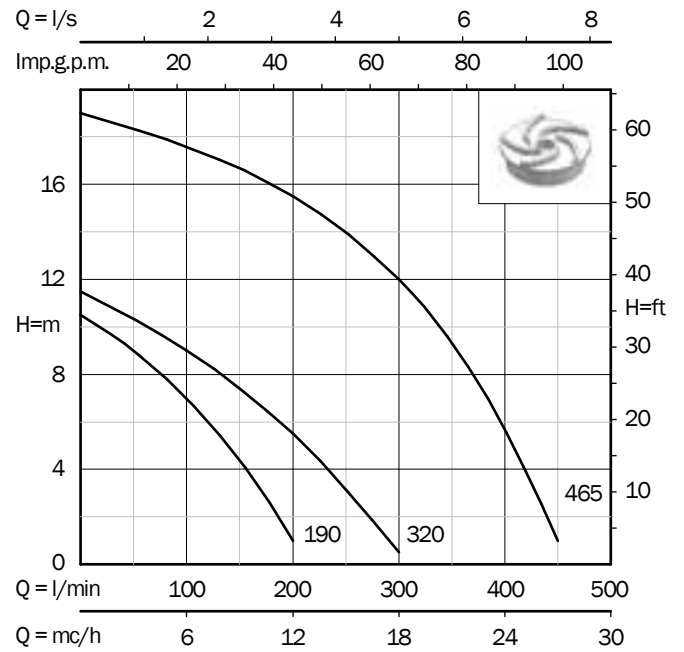
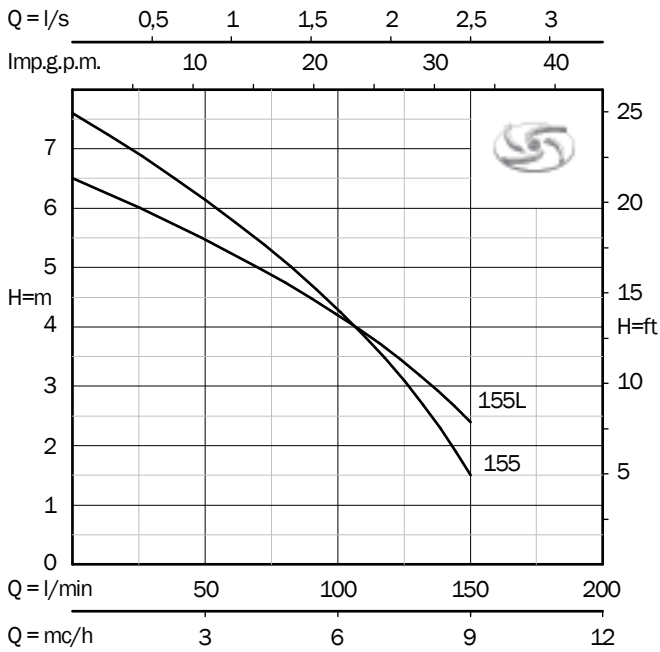

# Electric submersible pumps SEMISOM series VA

for grey water, vertical discharge automatics

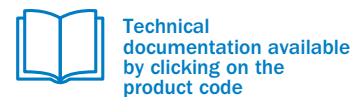

## PERFORMANCE DATA 2 poles 50 Hz

Open impeller 	Code	Version		P2		Max	Flow		Ø solid passage (mm)	DNM (GAS)	Dimensions (mm)			Weight kg
				hp	kW	A	l/min	m			A	B	C	
SEMINOX 155 VA	SM155+G	230 V	1-phase+float	0,33	0,25	1,9	30 - 100	6,8 - 4,3	10	1"¼	273	20	167	4,6
SEMINOX 155L VA	SM155L+G	230 V	1-phase+float	0,33	0,25	2,2	30 - 100	5,9 - 4,2	20	1"¼	304	45	167	5



### SUPPLIED WITH

5 meters power cable and Schuko plug



Capacitor and built-in thermal protector

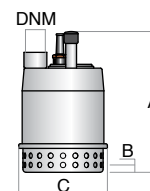

## PERFORMANCE DATA 2 poles 50 Hz

Open impeller 	Code	Version		P2		Max	Flow		Ø solid passage (mm)	DNM (GAS)	Dimensions (mm)				Weight kg
				hp	kW	A	l/min	m			A	B	C	D	
SEMISOM 190 VA	SM190+G/3	230 V	1-phase+float	0,5	0,37	2,5	30 - 150 - 200	9,5 - 4 - 1	5	1"¼	393	50	225	164	12,8
SEMISOM 320 VA	SM320+G/3	230 V	1-phase+float	0,75	0,55	4,2	30 - 200 - 300	11 - 5,5 - 0,5	13	1"¼	418	50	225	164	14,9
	ST320+G/2	400 V	3-phase+float			1,7									16,7
SEMISOM 465 VA	SM465+G/3	230 V	1-phase+float	1,5	1,1	7,3	100 - 300 - 450	17,5 - 12 - 1	5	2"	484	60	250	172	21,8
	ST465+G/2	400 V	3-phase+float			2,7									23,6



### SUPPLIED WITH

Power cable:

- 5 meters for single-phase versions
- 10 meters for three-phase versions



Capacitor and thermal protector put in a separate, easy-accessible, water tight chamber (single-phase versions)



Mini-contactor put in a separate, easy-accessible chamber (three-phase versions)

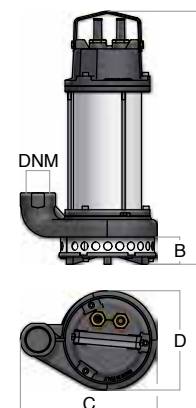

# Electric submersible pumps SEMISOM series VS

for grey water, vertical discharge



## PERFORMANCE DATA 2 poles 50 Hz

Open impeller 	Code	Version		P2		Max A	Flow		Ø solid passage (mm)	DNM (GAS)	Dimensions (mm)				Weight kg
				hp	kW		l/min	m			A	B	C	D	
SEMISOM 190 VS	SM190	230 V	1-phase	0,5	0,37	2,5	30 - 150 - 200	9,5 - 4 - 1	5	1"¼	335	50	225	164	10,8
	SM190+G	230 V	1-phase+float												11
	ST190	400 V	3-phase												1,2
SEMISOM 320 VS	SM320	230 V	1-phase	0,75	0,55	4,2	30 - 200 - 300	11 - 5,5 - 0,5	13	1"¼	360	50	225	164	13
	SM320+G	230 V	1-phase+float												13,2
	ST320	400 V	3-phase												1,7
SEMISOM 465 VS	SM465	230 V	1-phase	1,5	1,1	7,3	100 - 300 - 450	17,5 - 12 - 1	5	2"	440	60	250	172	19,5
	SM465+G	230 V	1-phase+float												19,7
	ST465	400 V	3-phase												2,7

## PERFORMANCE DATA - 24 V Direct current

Open impeller 	Code	Version		P2		P1 kW	Max A	Flow		Ø solid passage (mm)	DNM (GAS)	Dimensions (mm)				Weight kg
				hp	kW			l/min	m			A	B	C	D	
SEMISOM 190 VS	SF190	24 V	DC	0,5	0,37	0,58	24	30 - 150 - 200	9,5 - 4 - 1	5	1"¼	385	50	225	164	10,2
SEMISOM 320 VS	SF320	24 V	DC	0,75	0,55	0,67	28	30 - 200 - 300	11 - 5,5 - 0,5	13	1"¼	400	50	225	164	11,6

P1: Max. absorbed power - P2: Nominal power of the motor



### SUPPLIED WITH

5 meters power cable



Control box containing capacitor and amperometric protection (single-phase versions)

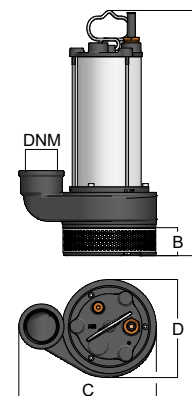

## ACCESSORIES

Code	Description
02076100	QDC electromechanical direct starter (24 V Direct current versions)



# Electric submersible pumps SEMISOM series HS

for grey water, horizontal discharge

 Technical documentation available by clicking on the product code

## PERFORMANCE DATA 2 poles 50 Hz

Open impeller 	Code	Version		P2		Max A	Flow		Ø solid passage (mm)	DNM (GAS)	Dimensions (mm)				Weight kg
				hp	kW		l/min	m			A	B	C	D	
SEMISOM 130 HS	SM130	230 V	1-phase	1,5	1,1	7,6	20 - 60 - 100	29 - 23,5 - 15	5	1"½	426	69	240	190	22,2
	SM130+G	230 V	1-phase+float												22,4
	ST130	400 V	3-phase												2,9



### SUPPLIED WITH

10 meters power cable



Control box containing capacitor and amperometric protection (single-phase versions)

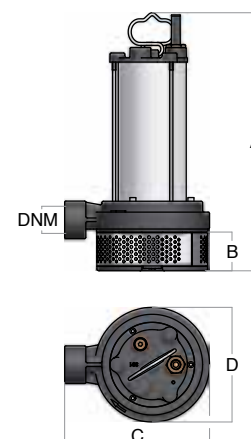

## ACCESSORIES

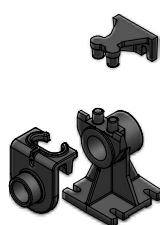
Code	Description
04105042	<p>Guide rail kit male threaded inlet G1"½ -female threaded outlet G2" (¾" guide poles are not included)</p> 





# SEMISOM

FOR SEWAGE WATER





# Electric submersible pumps SEMISOM

for sewage water



## APPLICATION

Electric submersible pumps for installations in domestic, civil and industrial environments.

Suitable to convey dirty, waste and sewage water also containing suspended solids whose size is up to 65 mm.

They are recommended to transfer water, to drain tanks or flooded spaces, to pump waste water coming from domestic, civil and industrial installations as well as the drainage of septic tanks. They can also be used to pump sewage keeping its biological process unchanged (4 pole version).

Some models of this range are also available in 24V DC version.

## CHARACTERISTICS

IP rating	IP68
Duty (versions 1~230V - 3~400V)	Continuous S1
Duty (versions 24V DC)	Limited use S2 (60 minutes)
Maximum immersion depth (m)	20
Maximum number of starts per hour	40
Maximum temperature of the liquid pumped versions 1~230V - 3~400V (°C)	50
Maximum temperature of the liquid pumped versions 24V DC (°C)	35
PH of the liquid pumped	6 - 10
Density of the liquid pumped (kg/dm <sup>3</sup> )	<1,1
Suitable for inverter drive	Three-phase versions only

## APPLICATION RANGE

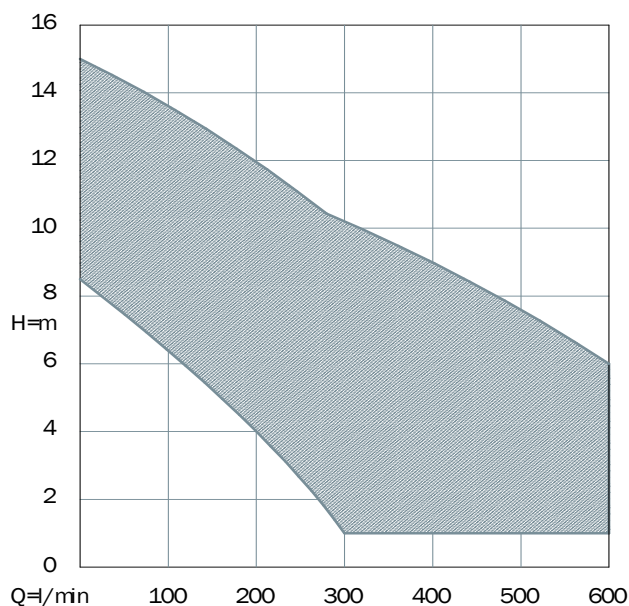

## CONSTRUCTION

1~230V - 3~400V versions: coolant filled, asynchronous, rewindable electric AC motor with short circuit rotor. Insulation Class F. Windings with phase insulators to protect the motor from power peaks, as a guarantee of a highly-trustworthy product.

24V DC versions: with permanent magnets dry electric DC motor. Insulation Class F

Resin-insulated cable kit to prevent penetration of water inside the motor

Shafts machined on ball bearings and mechanical seals location

Double seal with interposed oil chamber

## MATERIALS

Tie rods, handle, motor casing, bolts and nuts	Stainless Steel AISI304
Shaft	Stainless Steel AISI420B
Cover and volute	Mechanical cast iron EN GJL-250
Impeller	Mechanical cast iron EN GJL-200
Mechanical seal	Silicon carbide and alumina
Packing Ring	NBR rubber
Elastomers	NBR rubber
Cable	Neoprene H07RN8-F; 24V DC: Twin Batt

# Electric submersible pumps SEMISOM





for sewage water





## PERFORMANCE DATA

Vortex Impeller 	P2		1~230 V		3~400 V	24 V DC	Poles	Ø solid passage (mm)	Q	Flow												
	hp	kW	Max	µF	Max	Max				m³/h	0	6	9	12	15	18	21	24	27	30	36	
			A		A	A					l/min	0	100	150	200	250	300	350	400	450	500	600
SEMISOM 290	0,75	0,55	4,2	16	1,7	28	2	50	H (m)	8,5	7	6,5	5,5	4,5	3,5	2,5	1					
SEMISOM 390	1	0,75	6,3	16	2,4		2	50		10	8,5	8	7	6	5	4	3	2				
SEMISOM 504	1	0,75	6,1	20	2,5		4	50		6,2	6	5,7	5,4	5,1	4,8	4,5	4,2	3,8	3			
SEMISOM 490	1,5	1,1	7,3	20	2,7		2	50		11	9,5	9	8	7,5	6,5	5,5	5	4	3	1		
SEMISOM 590	2	1,5	10,5	31,5	4,1		2	50		14,5	13	12,5	11,5	11	10	9	8	7,5	6,5	5		
NEW SEMISOM 650	2	1,5	12	31,5	4,6		2	65		9	8	7,5	7	6,5	6	5,5	5	4,5	4	3		
NEW SEMISOM 650 H	2	1,5	12	31,5	4,6		2	65		12,8	12	11,6	11,1	10,7	10,2	9,5	8,8	8,1	7,5	6		

Channel impeller 	P2		1~230 V		3~400 V	24 V DC	Poles	Ø solid passage (mm)	Q	Flow											
	hp	kW	Max	µF	Max	Max				m³/h	0	6	9	12	15	18	21	24	27	30	36
			A		A	A					l/min	0	100	150	200	250	300	350	400	450	500
SEMISOM 262	0,75	0,55	4,2	16	1,7	28	2	32	H (m)	10,5	9	8	7	6	4,5	3	1				
SEMISOM 635	1,5	1,1	7,3	20	2,7		2	32		15	13,5	13	12	11	10	9	7,5	6,5	5	2	

## AVAILABLE VERSIONS

Vortex Impeller 	Vertical discharge	Horizontal discharge	Flanged discharge	Single-phase	Single-phase + Float switch	Single-phase + float. and Internal capacitor	Three-phase	Three-phase + float	24 V
									
SEMISOM 290	•			VS	VS	VA	VS	VA	VS
		•		HS	HS	HA	HS		
SEMISOM 390	•			VS	VS	VA	VS	VA	
		•		HS	HS	HA	HS		
SEMISOM 504		•		HS	HS		HS		
SEMISOM 490	•			VS	VS	VA	VS	VA	
		•		HS	HS	HA	HS		
SEMISOM 590		•		HS	HS		HS		
NEW SEMISOM 650			•	FS	FS		FS		
NEW SEMISOM 650 H			•	FS	FS		FS		

Channel impeller 	Vertical discharge	Horizontal discharge	Flanged discharge	Single-phase	Single-phase + Float switch	Single-phase + float. and Internal capacitor	Three-phase	Three-phase + float	24 V
									
SEMISOM 262	•			VS	VS	VA	VS	VA	VS
SEMISOM 635	•			VS	VS	VA	VS	VA	
		•		HS	HS	HA	HS		

V = Vertical discharge; H = Horizontal discharge; F = Flanged discharge  
S = Standard version; A = Automatic version

## PERFORMANCE CURVES

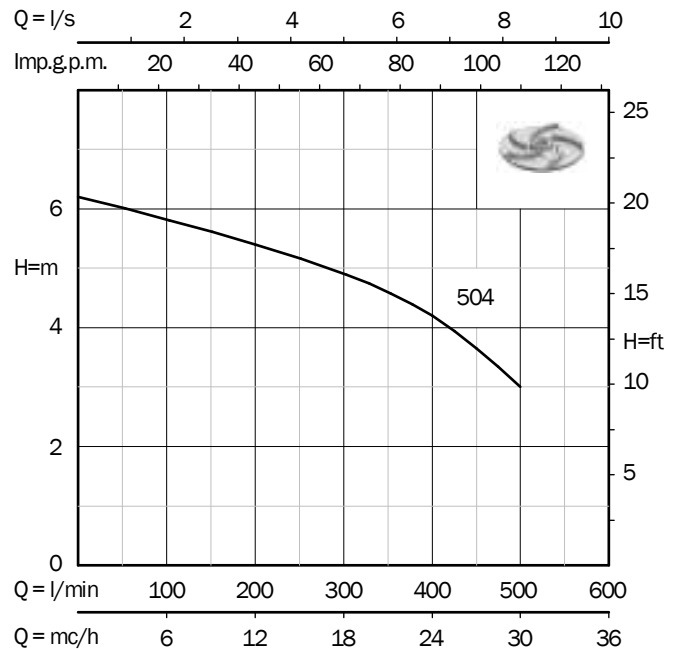
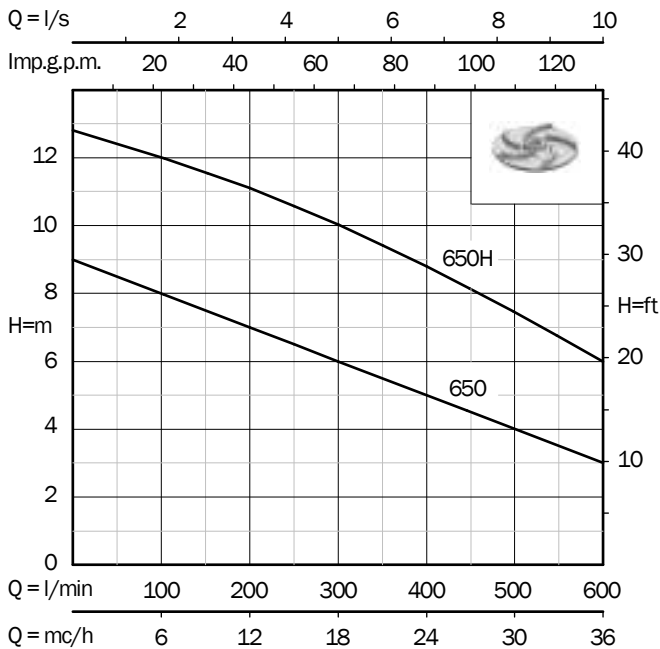
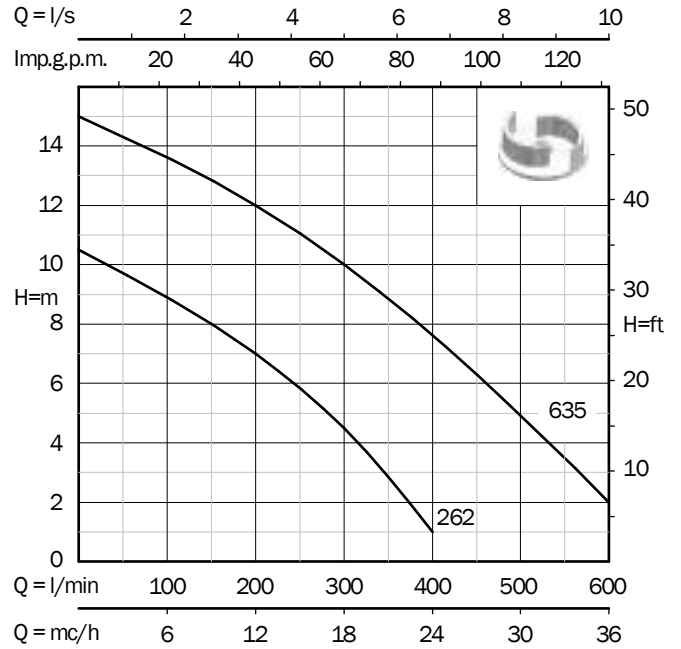
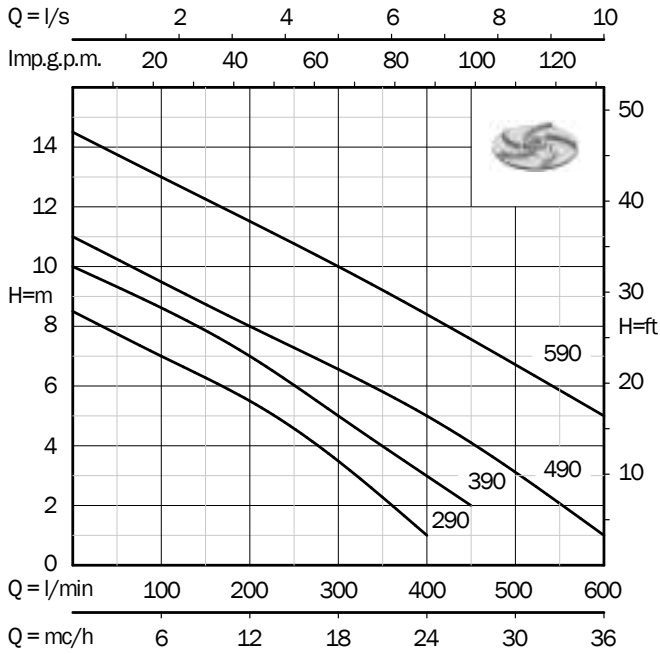

# Electric submersible pumps SEMISOM series VA

for sewage water, vertical discharge automatics

 Technical documentation available by clicking on the product code

## PERFORMANCE DATA 2 poles 50 Hz

Vortex Impeller 	Code	Version		P2		Max A	Flow		Ø solid passage (mm)	DNM (GAS)	Dimensions (mm)				Weight kg
				hp	kW		l/min	m			A	B	C	D	
<b>SEMISOM 290 VA</b>	SM290+G/3	230 V	1-phase+float	0,75	0,55	4,2	100 - 200 - 400	7 - 5,5 - 1	50	2"	492	65	235	162	16,9
	ST290+G/2	400 V	3-phase+float			1,7									18,7
<b>SEMISOM 390 VA</b>	SM390+G/3	230 V	1-phase+float	1	0,75	6,3	100 - 250 - 450	8,5 - 6 - 2	50	2"	502	65	235	162	17,7
	ST390+G/2	400 V	3-phase+float			2,4									19,5
<b>SEMISOM 490 VA</b>	SM490+G/3	230 V	1-phase+float	1,5	1,1	7,3	100 - 250 - 600	9,5 - 7,5 - 1	50	2"	527	65	235	162	19,5
	ST490+G/2	400 V	3-phase+float			2,7									21,3

### SUPPLIED WITH

Power cable:  
 • 5 meters for single-phase versions  
 • 10 meters for three-phase versions



Capacitor and thermal protector put in a separate, easy-accessible, water tight chamber (single-phase versions)



Mini-contactor put in a separate, easy-accessible chamber (three-phase versions)

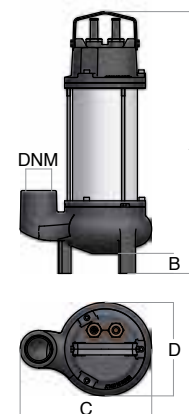

## PERFORMANCE DATA 2 poles 50 Hz

Channel impeller 	Code	Version		P2		Max	Flow		Ø solid passage (mm)	DNM (GAS)	Dimensions (mm)				Weight kg
				hp	kW	A	l/min	m			A	B	C	D	
<b>SEMISOM 262 VA</b>	SM262+G/3	230 V	1-phase+float	0,75	0,55	4,2	30 - 200 - 400	10 - 7 - 1	32	2"	450	60	250	172	19,1
	ST262+G/2	400 V	3-phase+float			1,7									20,9
<b>SEMISOM 635 VA</b>	SM635+G/3	230 V	1-phase+float	1,5	1,1	7,3	30 - 350 - 600	14,5 - 9 - 2	32	2"	484	60	250	172	21,3
	ST635+G/2	400 V	3-phase+float			2,7									23,1

### SUPPLIED WITH



Power cable:  
 • 5 meters for single-phase versions  
 • 10 meters for three-phase versions



Capacitor and thermal protector put in a separate, easy-accessible, water tight chamber (single-phase versions)



Mini-contactor put in a separate, easy-accessible chamber (three-phase versions)

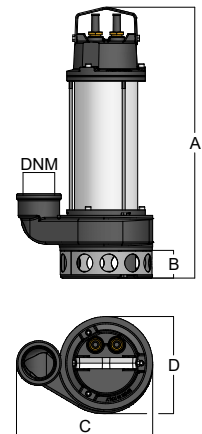

# Electric submersible pumps SEMISOM series VS

for sewage water, vertical discharge

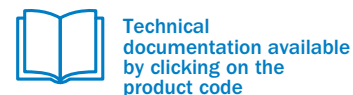

## PERFORMANCE DATA 2 poles 50 Hz

Vortex Impeller 	Code	Version		P2		Max A	Flow		Ø solid passage (mm)	DNM (GAS)	Dimensions (mm)				Weight kg
				hp	kW		l/min	m			A	B	C	D	
SEMISOM 290 VS	SM290	230 V	1-phase	0,75	0,55	4,2	100 - 200 - 400	7 - 5,5 - 1	50	2"	440	65	235	162	14,4
	SM290+G	230 V	1-phase+float												14,6
	ST290	400 V	3-phase												1,7
SEMISOM 390 VS	SM390	230 V	1-phase	1	0,75	6,3	100 - 250 - 450	8,5 - 6 - 2	50	2"	450	65	235	162	15,7
	SM390+G	230 V	1-phase+float												15,9
	ST390	400 V	3-phase												2,4
SEMISOM 490 VS	SM490	230 V	1-phase	1,5	1,1	7,3	100 - 250 - 600	9,5 - 7,5 - 1	50	2"	474	65	235	162	16,5
	SM490+G	230 V	1-phase+float												16,7
	ST490	400 V	3-phase												2,7

## PERFORMANCE DATA - 24 V Direct current

Vortex Impeller 	Code	Version		P2		P1 kW	Max A	Flow		Ø solid passage (mm)	DNM (GAS)	Dimensions (mm)				Weight kg
				hp	kW			l/min	m			A	B	C	D	
SEMISOM 290 VS	SF290	24 V	DC	0,75	0,55	0,67	28	100 - 200 - 400	7 - 5,5 - 1	50	2"	440	65	235	162	13,4

P1: Max. absorbed power - P2: Nominal power of the motor



### SUPPLIED WITH

5 meters power cable



Control box containing capacitor and amperometric protection (single-phase versions)

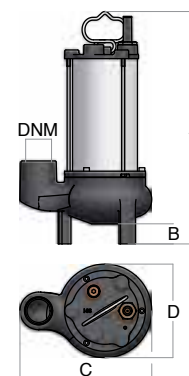

## ACCESSORIES

Code	Description
02076100	QDC electromechanical direct starter (24 V Direct current versions)





### PERFORMANCE DATA 2 poles 50 Hz

Channel impeller 	Code	Version		P2		Max A	Flow		Ø solid passage (mm)	DNM (GAS)	Dimensions (mm)				Weight kg
				hp	kW		l/min	m			A	B	C	D	
SEMISOM 262 VS	SM262	230 V	1-phase	0,75	0,55	4,2	30 - 200 - 400	10 - 7 - 1	32	2"	400	60	250	172	16,7
	SM262+G	230 V	1-phase+float												16,9
	ST262	400 V	3-phase												1,7
SEMISOM 635 VS	SM635	230 V	1-phase	1,5	1,1	7,3	30 - 350 - 600	14,5 - 9 - 2	32	2"	440	60	250	172	19,3
	SM635+G	230 V	1-phase+float												19,5
	ST635	400 V	3-phase												2,7

### PERFORMANCE DATA - 24 V Direct current

Channel impeller 	Code	Version		P2		P1	Max A	Flow		Ø solid passage (mm)	DNM (GAS)	Dimensions (mm)				Weight kg
				hp	kW	kW		l/min	m			A	B	C	D	
SEMISOM 262 VS	SF262	24 V	DC	0,75	0,55	0,67	28	30 - 200 - 400	10 - 7 - 1	32	2"	400	60	250	172	15,3

P1: Max. absorbed power - P2: Nominal power of the motor



#### SUPPLIED WITH

5 meters power cable



Control box containing capacitor and amperometric protection (single-phase versions)

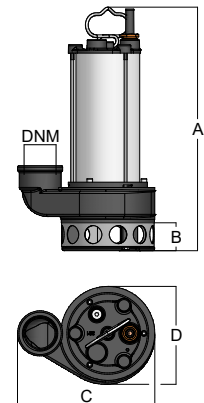

### ACCESSORIES

Code	Description
02076100	QDC electromechanical direct starter (24 V Direct current versions)



# Electric submersible pumps SEMISOM series HA

for sewage water, horizontal discharge automatics

 Technical documentation available by clicking on the product code

## PERFORMANCE DATA 2 poles 50 Hz

Vortex Impeller 	Code	Version		P2		Max A	Flow		Ø solid passage (mm)	DNM (GAS)	Dimensions (mm)				Weight kg
				hp	kW		l/min	m			A	B	C	D	
SEMISOM 290 HA	SM290+G0/3	230 V	1-phase+float	0,75	0,55	4,2	100 - 200 - 400	7 - 5,5 - 1	50	2"	492	65	198	162	16,4
SEMISOM 390 HA	SM390+G0/3	230 V	1-phase+float	1	0,75	6,3	100 - 250 - 450	8,5 - 6 - 2	50	2"	502	65	198	162	17,5
SEMISOM 490 HA	SM490+G0/3	230 V	1-phase+float	1,5	1,1	7,3	100 - 250 - 600	9,5 - 7,5 - 1	50	2"	526	65	198	162	18,8



### SUPPLIED WITH

10 meters power cable



Capacitor and thermal protector put in a separate, easy-accessible, water tight chamber

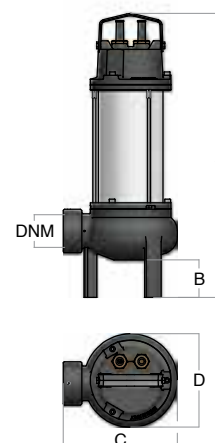

## ACCESSORIES

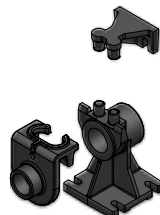
Code	Description
04105043	<p>Guide rail kit male threaded inlet G2" - female threaded outlet G2" (<math>\frac{3}{4}</math>" guide poles are not included)</p> 

## PERFORMANCE DATA 2 poles 50 Hz

Channel impeller 	Code	Version		P2		Max A	Flow		Ø solid passage (mm)	DNM (GAS)	Dimensions (mm)				Weight kg
				hp	kW		l/min	m			A	B	C	D	
<b>SEMISOM 635 HA</b>	SM635+GO/3	230 V	1-phase+float	1,5	1,1	7,3	30 - 350 - 600	14,5 - 9 - 2	32	2"	484	60	220	172	22



### SUPPLIED WITH

10 meters power cable



Capacitor and thermal protector put in a separate, easy-accessible, water tight chamber

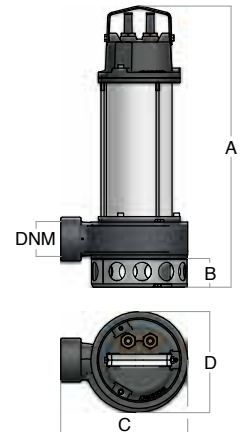

## ACCESSORIES

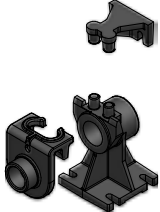
Code	Description
04105043	<p>Guide rail kit male threaded inlet G2" - female threaded outlet G2"</p> <p>(<math>\frac{3}{4}</math>" guide poles are not included)</p> 

# Electric submersible pumps SEMISOM series HS

for sewage water, horizontal discharge

 Technical documentation available by clicking on the product code

## PERFORMANCE DATA 2 poles 50 Hz

Vortex Impeller 	Code	Version		P2		Max A	Flow		Ø solid passage (mm)	DNM (GAS)	Dimensions (mm)				Weight kg
				hp	kW		l/min	m			A	B	C	D	
SEMISOM 290 HS	SM2900	230 V	1-phase	0,75	0,55	4,2	100 - 200 - 400	7 - 5,5 - 1	50	2"	440	65	198	162	14,4
	SM290+GO	230 V	1-phase+float												14,6
	ST2900	400 V	3-phase												1,7
SEMISOM 390 HS	SM3900	230 V	1-phase	1	0,75	6,3	100 - 250 - 450	8,5 - 6 - 2	50	2"	450	65	198	162	15,7
	SM390+GO	230 V	1-phase+float												15,9
	ST3900	400 V	3-phase												2,4
SEMISOM 490 HS	SM4900	230 V	1-phase	1,5	1,1	7,3	100 - 250 - 600	9,5 - 7,5 - 1	50	2"	474	65	198	162	16,5
	SM490+GO	230 V	1-phase+float												16,7
	ST4900	400 V	3-phase												2,7
SEMISOM 590 HS	SM5900	230 V	1-phase	2	1,5	10,5	100 - 300 - 600	13 - 10 - 5	50	2"	496	65	198	162	18,2
	SM590+GO	230 V	1-phase+float												18,4
	ST5900	400 V	3-phase												4,1



### SUPPLIED WITH

10 meters power cable



Control box containing capacitor and amperometric protection (single-phase versions)

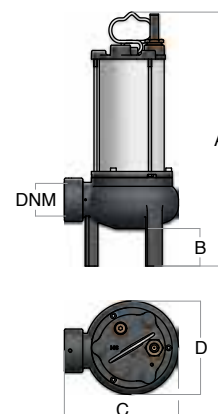

## ACCESSORIES

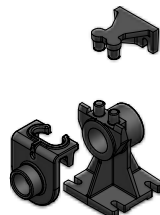
Code	Description
04105043	<p>Guide rail kit male threaded inlet G2" - female threaded outlet G2"</p> <p>(3/4" guide poles are not included)</p> 

## PERFORMANCE DATA 4 poles 50 Hz

Vortex Impeller 	Code	Version		P2		Max A	Flow		Ø solid passage (mm)	DNM (GAS)	Dimensions (mm)				Weight kg
				hp	kW		l/min	m			A	B	C	D	
<b>SEMISOM 504 HS</b>	SM5040	230 V	1-phase	1	0,75	6,1	100 - 300 - 500	6 - 4,8 - 3	50	2"	498	50	225	171	20,2
	SM504+G0	230 V	1-phase+float												20,4
	ST5040	400 V	3-phase												2,5



### SUPPLIED WITH

10 meters power cable



Control box containing capacitor and amperometric protection (single-phase versions)

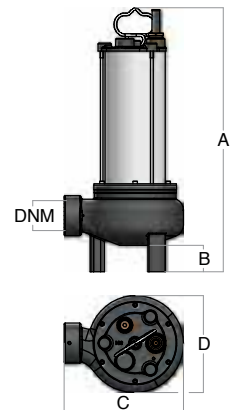

## ACCESSORIES

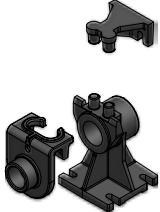
Code	Description
04105043	<p>Guide rail kit male threaded inlet G2" - female threaded outlet G2"</p> <p>(3/4" guide poles are not included)</p> 

# Electric submersible pumps SEMISOM series HS

for sewage water, horizontal discharge

Technical documentation available by clicking on the product code

## PERFORMANCE DATA 2 poles 50 Hz

Channel impeller 	Code	Version		P2		Max A	Flow		Ø solid passage (mm)	DNM (GAS)	Dimensions (mm)				Weight kg
				hp	kW		l/min	m			A	B	C	D	
SEMISOM 635 HS	SM6350	230 V	1-phase	1,5	1,1	7,3	30 - 350 - 600	14,5 - 9 - 2	32	2"	440	60	220	172	20,1
	SM635+GO	230 V	1-phase+float												20,3
	ST6350	400 V	3-phase												2,7



### SUPPLIED WITH

10 meters power cable



Control box containing capacitor and amperometric protection (single-phase versions)

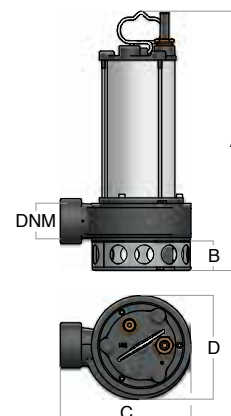

## ACCESSORIES

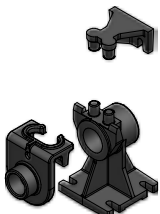
Code	Description
04105043	<p>Guide rail kit male threaded inlet G2" - female threaded outlet G2"</p> <p>(<math>\frac{3}{4}</math>" guide poles are not included)</p> 



**ILLUSTRATION OF AN INSTALLATION WITH GUIDE RAIL KIT**

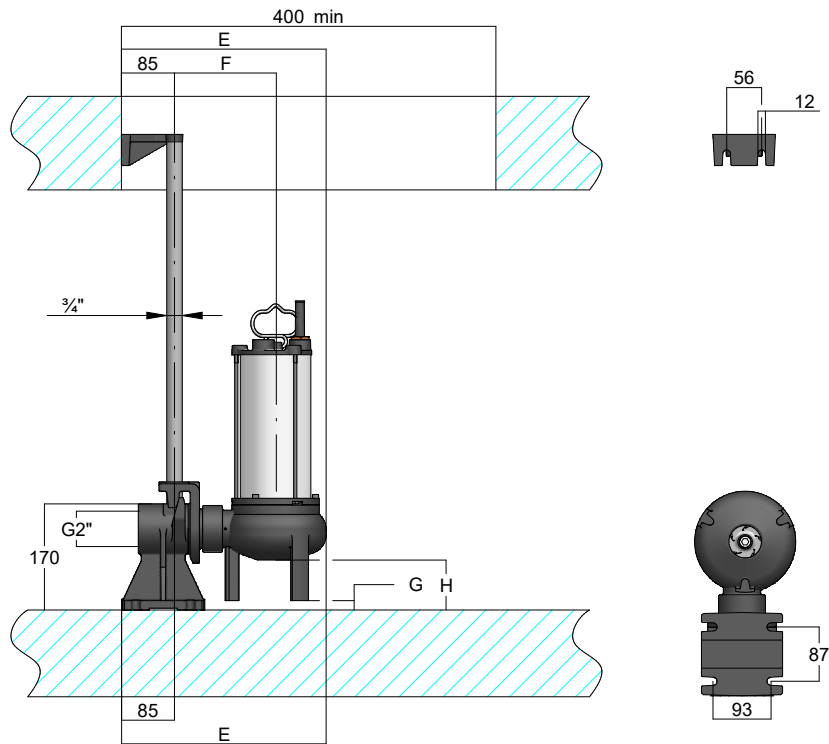

To be installed on	Dimensions (mm)			
	E	F	G	H
SEMISOM HS - HA	328	163	15	80
SEMISOM 635 HS - HA	348	180	47	97

# Electric submersible pumps SEMISOM series FS

for sewage water with horizontal flanged discharge

 Technical documentation available by clicking on the product code

## PERFORMANCE DATA 2 poles 50 Hz

Vortex Impeller 	Code	Version		P2		Max A	Flow		Ø solid passage (mm)	DNM (GAS)	Dimensions (mm)				Weight kg
				hp	kW		l/min	m			A	B	C	D	
<b>NEW</b> SEMISOM 650 FS	SM650/1	230 V	1-phase	2	1,5	12	100 - 300 - 600	8 - 6 - 3	65	65	511	65	245	195	24,4
	SM650+G/1	230 V	1-phase+float												24,7
	ST650/1	400 V	3-phase												4,6
<b>NEW</b> SEMISOM 650H FS	SM650H/1	230 V	1-phase	2	1,5	12	100 - 300 - 600	12 - 10,2 - 6	65	65	516	65	245	195	24,4
	SM650H+G/1	230 V	1-phase+float												24,7
	ST650H/1	400 V	3-phase												4,6



### SUITABLE FOR SYSTEMS CERTIFIED ACCORDING TO THE STANDARD UNI EN 12050-1

Designed for very heavy-duty applications with the aim of avoiding clogging and obstructions. Thanks to its 65 mm solids handling and the low-vane vortex impeller, the pump has brilliantly passed the tests listed in the UNI EN 12050-1 regulation (Wastewater lifting plants for buildings and sites).



#### SUPPLIED WITH

10 meters power cable



Control box containing capacitor and amperometric protection (single-phase versions)



UNI EN 1092-1  
DN65 PN6

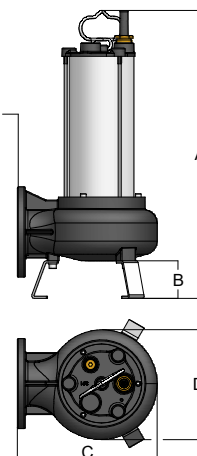

## ACCESSORIES

Codice	Descrizione	
05135011	Threaded flange inlet flange UNI EN 1092-1 DN65 PN6 - female threaded outlet G2" <sup>1</sup> / <sub>2</sub> + screws and rubber packing	
01205031	Pipe union inlet flange UNI EN 1092-1 DN65 PN6 - male threaded outlet G3" + screws and rubber packing	
04105052	Guide rail kit inlet flange UNI EN 1092-1 DN65 PN6 - outlet flange UNI EN 1092-1 DN65 PN40  (1" <sup>1</sup> / <sub>4</sub> guide poles not included)	

## ILLUSTRATION OF AN INSTALLATION WITH GUIDE RAIL KIT

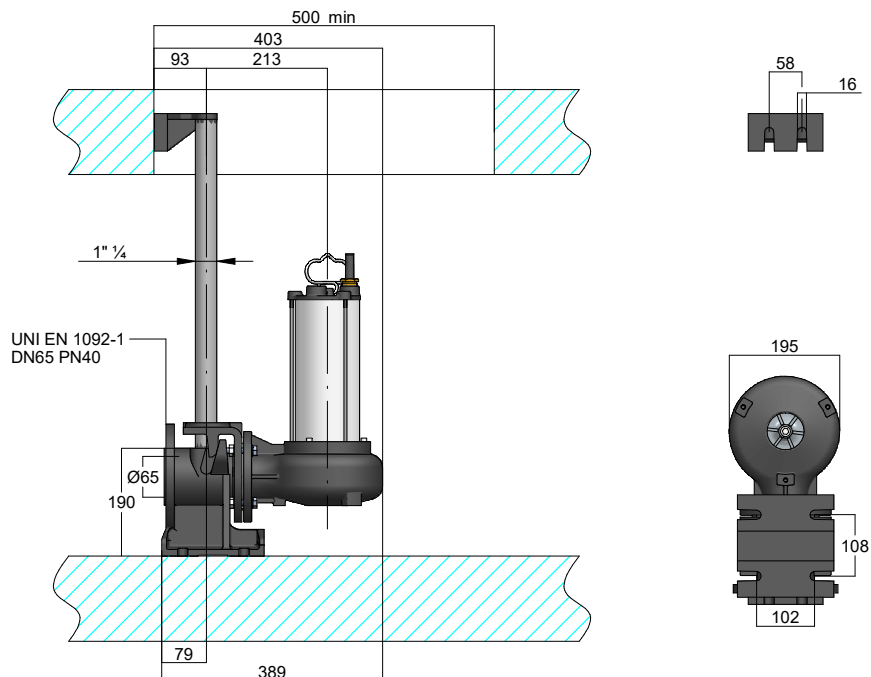

# SEMISOM GR



# Electric submersible pumps SEMISOM GR

for sewage water with grinder



## APPLICATION

Electric submersible pumps with grinder for installations in domestic, civil and industrial environments. They are supplied with a grinder whose blades are forged and tempered stainless steel allow to chop the solids and filaments in the waste or sewage water and thus to expel them even through relatively small pipeworks or when high head is required. They are recommended to pump waste water coming from domestic, civil and industrial installations as well as the drainage of septic tanks.

## CHARACTERISTICS

IP rating	IP68
Duty (versions 1~230V - 3~400V)	Continuous S1
Maximum immersion depth (m)	20
Maximum number of starts per hour	40
Maximum temperature of the liquid pumped versions 1~230V - 3~400V (°C)	50
PH of the liquid pumped	6 - 10
Density of the liquid pumped (kg/dm <sup>3</sup> )	<1,1
Suitable for inverter drive	Three-phase versions only

## APPLICATION RANGE

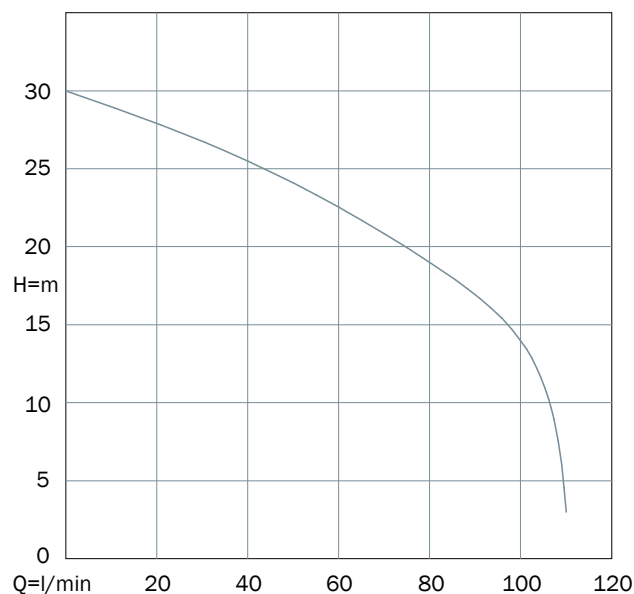

## CONSTRUCTION

Coolant filled, asynchronous, rewindable electric AC motor with short circuit rotor. Insulation Class F. Windings with phase insulators to protect the motor from power peaks, as a guarantee of a highly-trustworthy product.

Resin-insulated cable kit to prevent penetration of water inside the motor

Shafts machined on ball bearings and mechanical seals location

Double seal with interposed oil chamber

Grinder in forged and tempered stainless steel as a guarantee of high resistance

## MATERIALS

Tie rods, handle, motor casing, bolts and nuts	Stainless Steel AISI304
Shaft	Stainless Steel AISI420B
Cover and volute	Mechanical cast iron EN GJL-250
Impeller	Tecnopolymer reinforced with fibre-glass
Grinder	Forged and tempered Stainless steel AISI440C
Mechanical seal	Silicon carbide and alumina
Seal ring	NBR rubber
Elastomers	NBR rubber
Cable	Neoprene H07RN8-F

# Electric submersible pumps SEMISOM GR

for sewage water with grinder

 Technical documentation available by clicking on the product code

## PERFORMANCE DATA 2 poles 50 Hz

Grinder 	Code	Version		P2		Max		DNM (GAS)	Q	Flow							Dimensions (mm)				Weight kg	
				hp	kW	A	μF			m <sup>3</sup> /h	0	1,2	2,4	3,6	4,8	6	6,6	A	B	C		D
<b>SEMISOM 125 GR (no stands)</b>	SM125	230 V	1-phase	1,6	1,18	9,2	35	1"½	H (m)	30	27,5	25,5	22,5	19	14	3	416	29	240	190	22	
	SM125+G	230 V	1-phase+float														396				22,2	
	ST125	400 V	3-phase														2,9				21,2	
<b>SEMISOM 125 GR (with stands)</b>	SM125P	230 V	1-phase	1,6	1,18	9,2	35	1"½	H (m)	30	27,5	25,5	22,5	19	14	3	441	54	240	190	22,1	
	SM125+GP	230 V	1-phase+float														421				22,3	
	ST125P	400 V	3-phase														2,9				21,3	



### SUPPLIED WITH



10 meters power cable

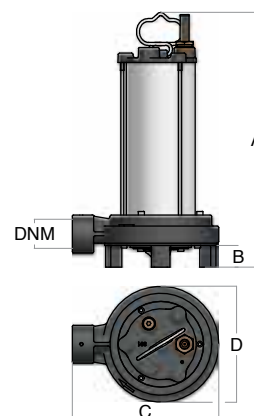

Junction box containing starting capacitor, unipolar thermal protector switch and facility to connect an extra 50 μF start-run capacitor (single-phase versions)

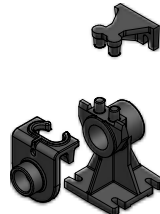

## ACCESSORIES

Code	Description	
02410016	90° zinc-plated elbow G1"½ m/f (to connect to the lifting station Semibox)	
02008200	Start-run capacitor 50 μF	
04105042	Guide rail kit male threaded inlet G1"½ -female threaded outlet G2" (¾" guide poles are not included)	



**PERFORMANCE CURVES - 2 poles 50 Hz**

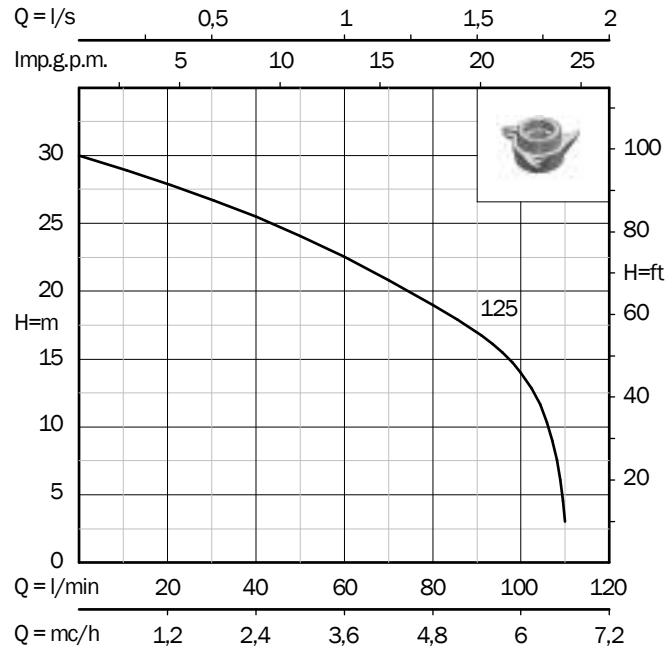

**ILLUSTRATION OF AN INSTALLATION WITH GUIDE RAIL KIT**

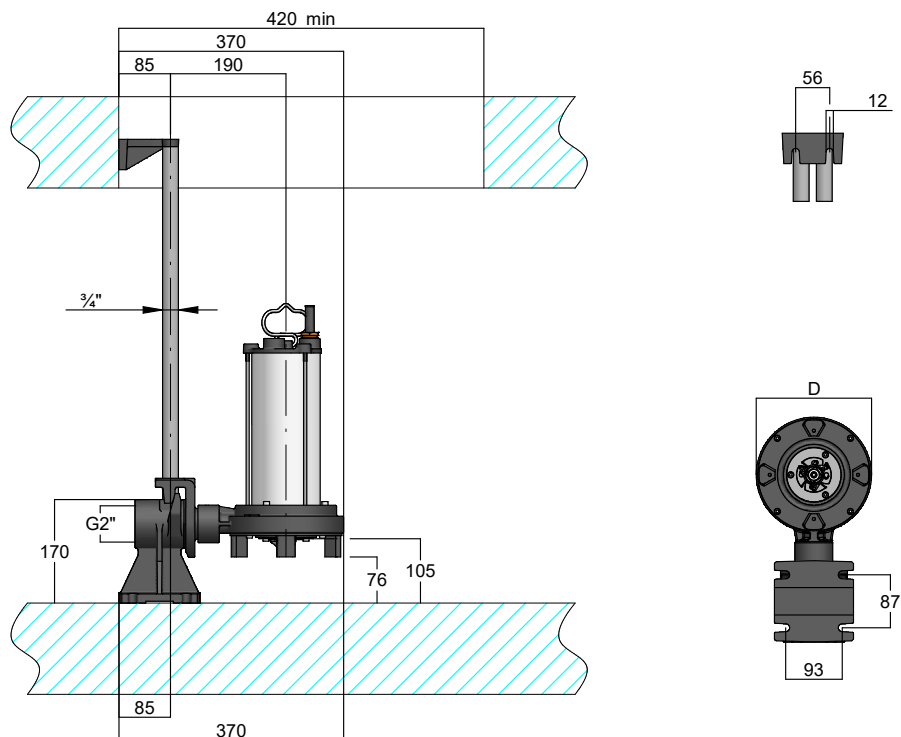

# SEMISOM /50 - /65

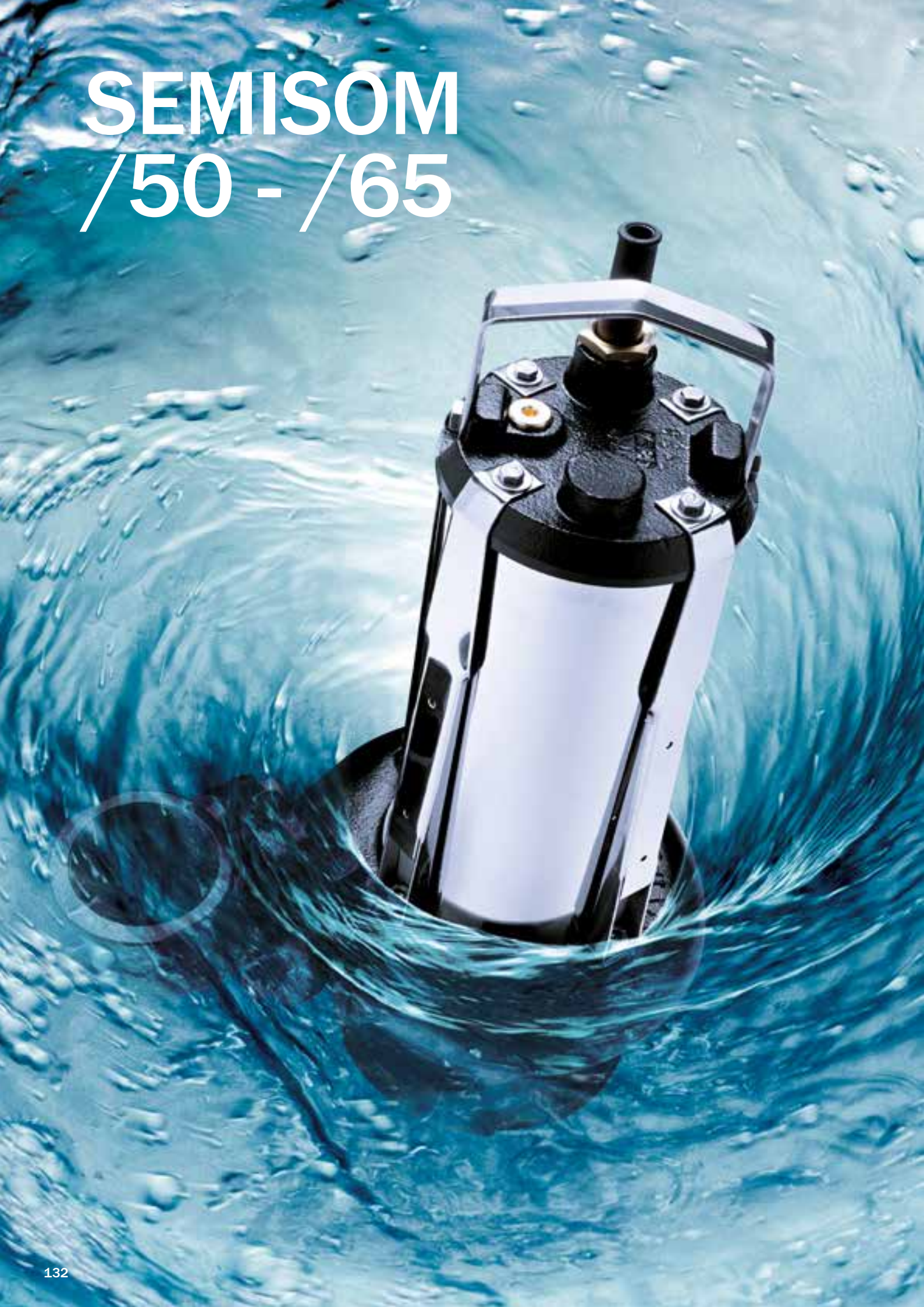

# Electric submersible pumps SEMISOM /50 - /65 for sewage water



## APPLICATION

Electric submersible pumps for installations in civil and industrial environments. Suitable to convey dirty, waste and sewage water also containing suspended solids whose size is up to 65 mm. They are recommended to transfer water, to drain tanks or flooded spaces, to pump water coming from civil and industrial installations as well as the drainage of septic tanks. They can also be used to pump sewage keeping its biological process unchanged (4 pole version).

## CHARACTERISTICS

IP rating	IP68
Duty	Continuous S1
Maximum immersion depth (m)	20
Maximum number of starts per hour	30
Maximum temperature of the liquid pumped (°C)	50
PH of the liquid pumped	6 - 10
Density of the liquid pumped (kg/dm <sup>3</sup> )	<1,1
Suitable for inverter drive	Only three-phase versions

## APPLICATION RANGE

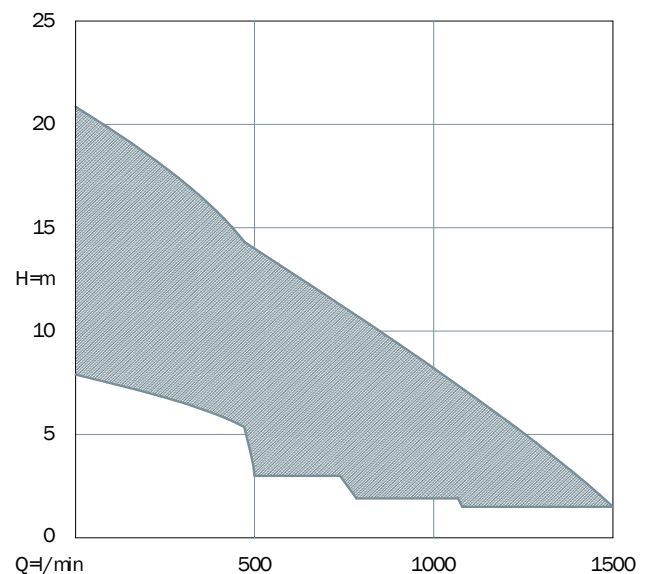

## CONSTRUCTION

Coolant filled, asynchronous, rewindable electric AC motor with short circuit rotor. Insulation Class F. Windings with phase insulators to protect the motor from power peaks, as a guarantee of a highly-trustworthy product.

Resin-insulated cable kit to prevent penetration of water inside the motor

Shafts machined on ball bearings and mechanical seals location

Double seal with interposed oil chamber

## MATERIALS

Tie rods, handle, motor casing, bolts and nuts	Stainless Steel AISI304
Shaft	Stainless Steel AISI420B
Cover and volute	Mechanical cast iron EN GJL-250
Impeller	Mechanical cast iron EN GJL-200
Mechanical seal	Silicon carbide and alumina
Seal ring	NBR rubber
Elastomers	NBR rubber
Cable	Neoprene H07RN8-F





## PERFORMANCE CURVES

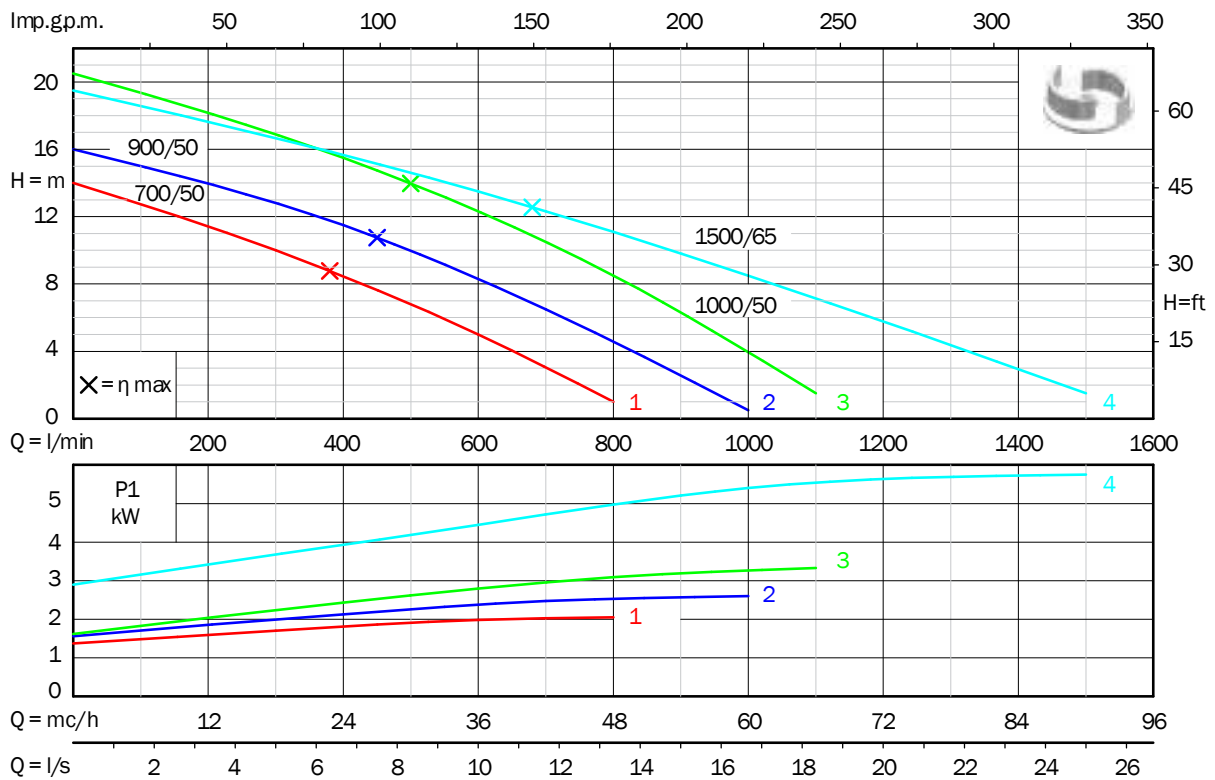
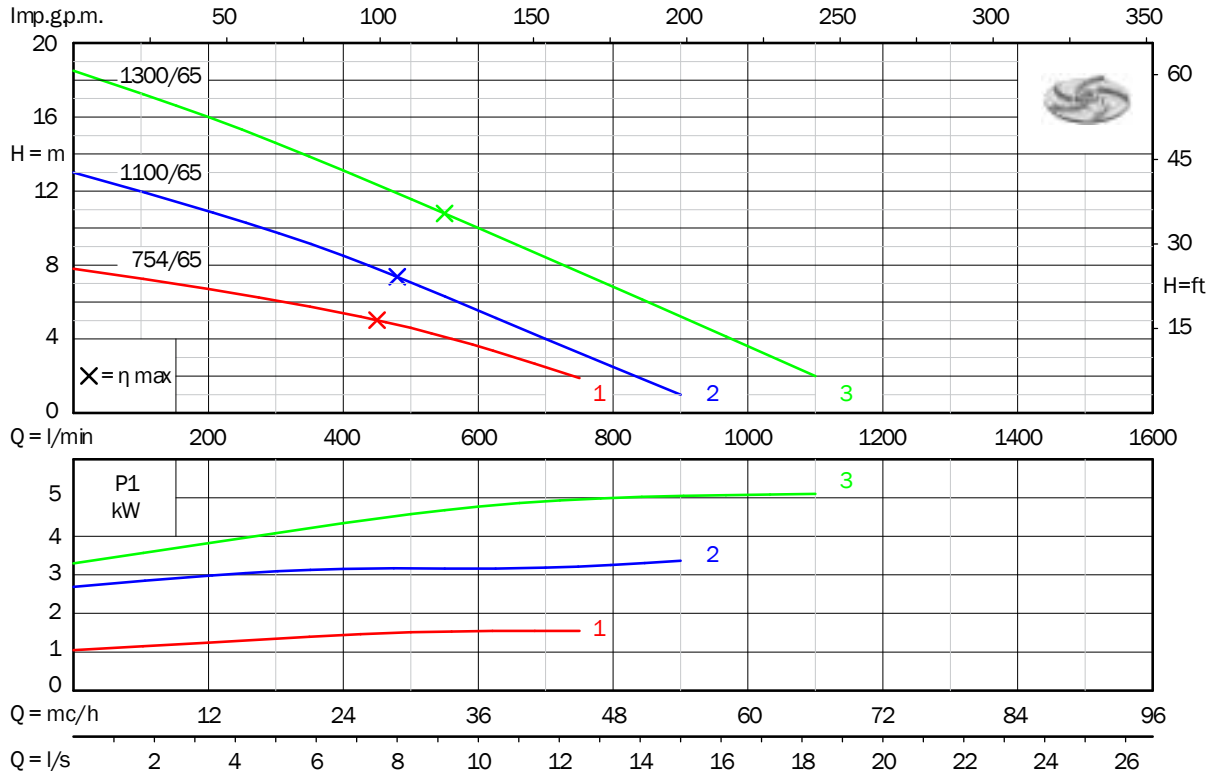

# Electric submersible pumps SEMISOM /50

for sewage water

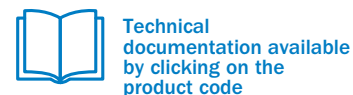

## PERFORMANCE DATA 2 poles 50 Hz

Vortex Impeller	Code	Version		P2		P1		Max	Flow		Ø solid passage (mm)	DNM (GAS)	Dimensions (mm)				Weight
				hp	kW	kW	A		l/min	m			A	B	C	D	
	SM/50/500/1	230 V	1-phase	1,5	1,1	1,84	9,2	100 - 300 - 500	9,5 - 7,5 - 3	50	2"	518	70	354	254	32	
	SM/50/500+G/1	230 V	1-phase+float													32,3	
	ST/50/500/1	400 V	3-phase													1,63	3,3
<b>SEMISOM 800/50</b>	SM/50/800/1	230 V	1-phase	2	1,5	2,21	11,4	100 - 300 - 600	11 - 9,5 - 4	50	2"½	543	70	362	254	34,5	
	SM/50/800+G/1	230 V	1-phase+float													34,8	
	ST/50/800/1	400 V	3-phase													2,07	4

P1: Max. absorbed power - P2: Nominal power of the motor

## PERFORMANCE DATA 2 poles 50 Hz

Channel impeller	Code	Version		P2		P1		Max	Flow		Ø solid passage (mm)	DNM (GAS)	Dimensions (mm)				Weight
				hp	kW	kW	A		l/min	m			A	B	C	D	
	SM/50/700/1	230 V	1-phase	1,5	1,1	2,05	9,2	100 - 400 - 800	13 - 8,5 - 1	50	2"	518	70	354	254	32,5	
	SM/50/700+G/1	230 V	1-phase+float													32,8	
	ST/50/700/1	400 V	3-phase													1,93	3,3
<b>SEMISOM 900/50</b>	SM/50/900/1	230 V	1-phase	2	1,5	2,6	11,4	100 - 500 - 1000	15 - 10 - 0,5	50	2"½	543	70	362	254	35	
	SM/50/900+G/1	230 V	1-phase+float													35,3	
	ST/50/900/1	400 V	3-phase													2,39	4
<b>SEMISOM 1000/50</b>	ST/50/1000/1	400 V	Trifase	3	2,2	3,33	5,9	100 - 500 - 1100	19,5 - 14 - 1,5	50	2"½	543	70	362	254	35	

P1: Max. absorbed power - P2: Nominal power of the motor

### SUPPLIED WITH

10 meters power cable



Control box containing capacitor and illuminated thermal protector switch (single-phase versions)



### OPTIONS

Version with thermic probe so to protect the motor from overheating (to be wired to protection/control panel type QT-MT - AM-AT)



UNI EN 1092-1  
DN40 PN6

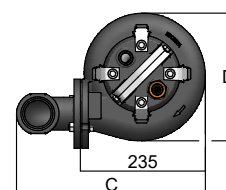
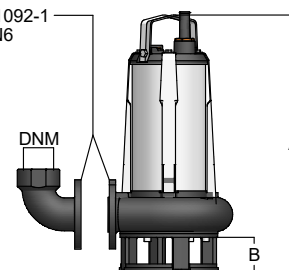



## ACCESSORIES

Code	Description
04105046	Guide rail kit inlet flange UNI EN 1092-1 DN40 PN6 - outlet flange UNI EN 1092-1 DN65 PN40 (1"¼ guide poles not included)

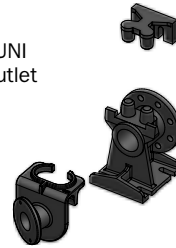

## ILLUSTRATION OF AN INSTALLATION WITH GUIDE RAIL KIT

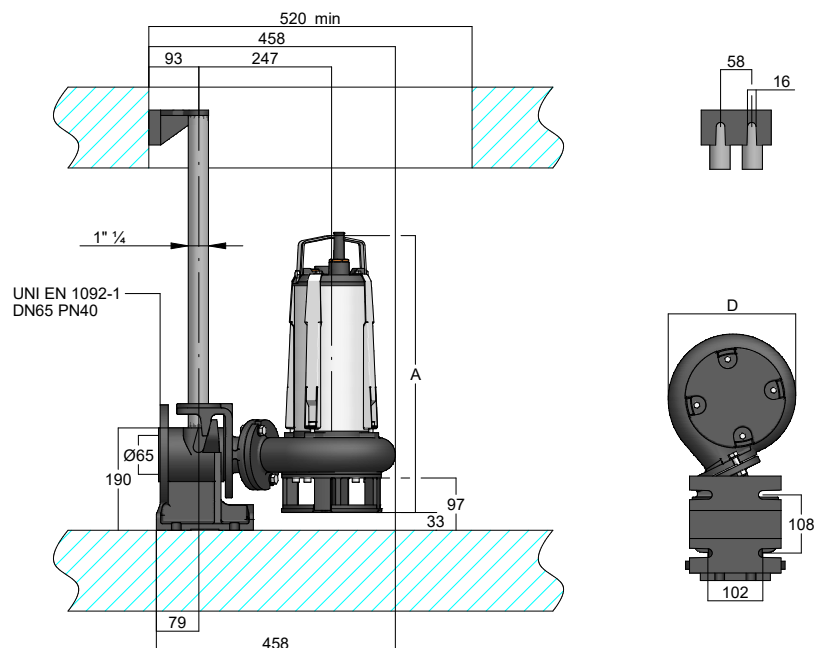

# Electric submersible pumps SEMISOM /65

for sewage water

 Technical documentation available by clicking on the product code

## PERFORMANCE DATA 2 poles 50 Hz

Vortex Impeller 	Code	Version		P2		P1	Max	Flow		Ø solid passage (mm)	Ø outlet (mm)	Dimensions (mm)				Weight kg
				hp	kW	kW		A	l/min			m	A	B	C	
SEMISOM 1100/65	ST/65/1100/1	400 V	3-phase	3	2,2	3,37	6	100 - 500 - 900	12 - 7 - 1	65	65	584	65	417	222	40
SEMISOM 1300/65	ST/65/1300/1	400 V	3-phase	4,5	3,4	5,1	8,1	100 - 600 - 1100	17 - 10 - 2	65	65	609	65	417	222	42,5

P1: Max. absorbed power - P2: Nominal power of the motor

## PERFORMANCE DATA 4 poles 50 Hz

Vortex Impeller 	Code	Version		P2		P1	Max	Flow		Ø solid passage (mm)	Ø outlet (mm)	Dimensions (mm)				Weight kg
				hp	kW	kW		A	l/min			m	A	B	C	
SEMISOM 754/65	SM/65/754/1	230 V	1-phase	1,6	1,2	1,55	7,7	100 - 400 - 750	7,3 - 5,5 - 1,9	65	65	569	65	417	222	38,5
	SM/65/754+G/1	230 V	1-phase+float													38,8
	ST/65/754/1	400 V	3-phase													1,45

P1: Max. absorbed power - P2: Nominal power of the motor

## PERFORMANCE DATA 2 poles 50 Hz

Channel impeller 	Code	Version		P2		P1	Max	Flow		Ø solid passage (mm)	Ø outlet (mm)	Dimensions (mm)				Weight kg
				hp	kW	kW		A	l/min			m	A	B	C	
SEMISOM 1500/65	ST/65/1500/1	400 V	3-phase	4,5	3,4	5,75	9	100 - 700 - 1500	18,5 - 12 - 1,5	65	65	609	65	417	222	44

P1: Max. absorbed power - P2: Nominal power of the motor

### SUPPLIED WITH

10 meters power cable



Control box containing capacitor and illuminated thermal protector switch (single-phase versions)



### OPTIONS

Version with thermic probe so to protect the motor from overheating (to be wired to protection/control panel type QT-MT - AM-AT)



UNI EN 1092-1  
DN65 PN6

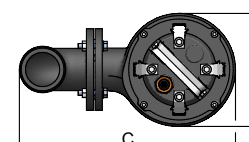
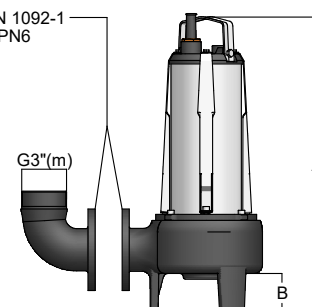

## ACCESSORIES

Code	Description
04105052	Guide rail kit inlet flange UNI EN 1092-1 DN65 PN6 - outlet flange UNI EN 1092-1 DN65 PN40 (1"¼ guide poles not included)

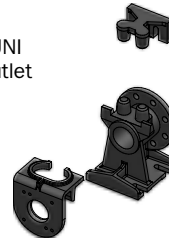

## ILLUSTRATION OF AN INSTALLATION WITH GUIDE RAIL KIT

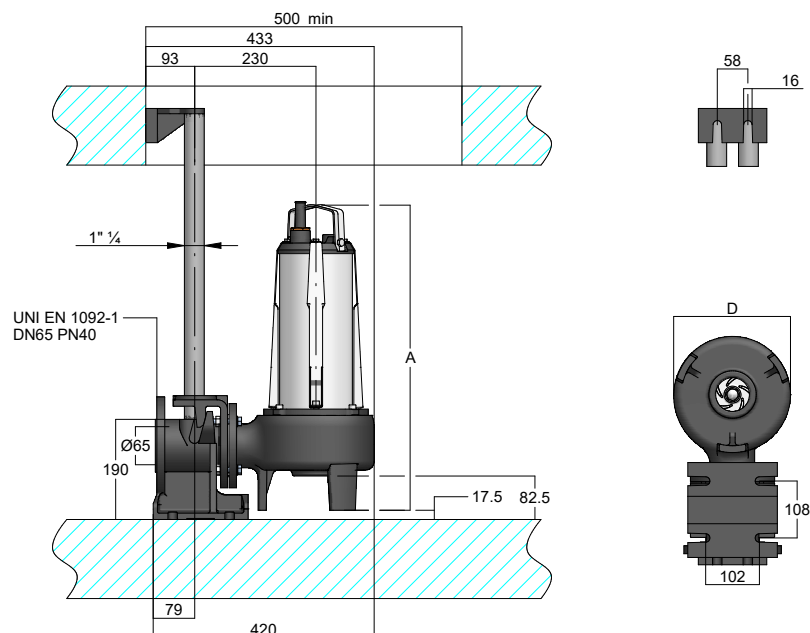

# SEMISOM /80





# Electric submersible pumps SEMISOM /80

for sewage water



## APPLICATION

Electric submersible pumps for installations in civil and industrial environments. Suitable to convey dirty, waste and sewage water also containing suspended solids whose size is up to 74 mm. They are recommended to transfer water, to drain tanks or flooded spaces, to pump water coming from civil and industrial installations as well as the drainage of septic tanks. They can also be used to pump sewage keeping its biological process unchanged (4 pole version).

## CHARACTERISTICS

IP rating	IP68
Duty	Continuous S1
Maximum immersion depth (m)	20
Maximum number of starts per hour	30
Maximum temperature of the liquid pumped (°C)	50
PH of the liquid pumped	6 - 10
Density of the liquid pumped (kg/dm <sup>3</sup> )	<1,1
Suitable for inverter drive	Yes

## APPLICATION RANGE

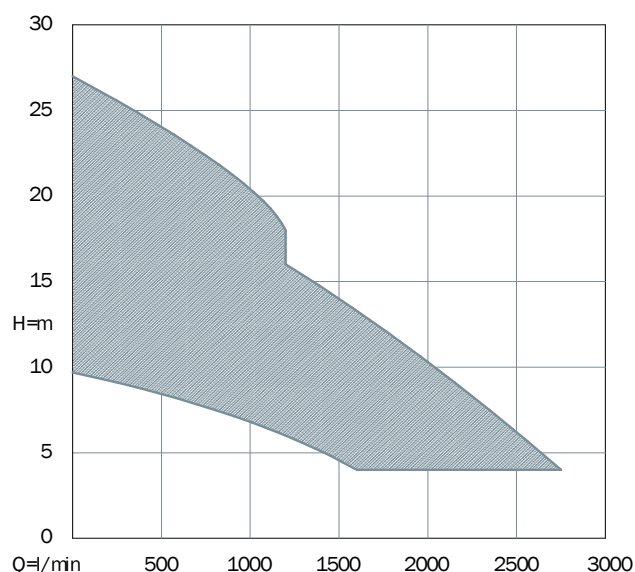

## CONSTRUCTION

Three-phase, asynchronous. Coolant-filled electric rewindable motor with short circuit rotor. Insulation class F. Winding with phase insulators to protect the motor from power peaks, as a guarantee of a highly reliable product.

Micro thermostat to protect the motor from overheating to be wired to the protection/control panel

Probe to detect water ingress in the oil chamber between the two mechanical seals to be wired to the protection/control panel

Resin-insulated cable kit to prevent penetration of water inside the motor

Shafts machined on ball bearings and mechanical seals location

Double seal with interposed oil chamber

## MATERIALS

Tie rods, handle, motor casing, bolts and nuts	Stainless Steel AISI304
Shaft	Stainless Steel AISI420B
Cover and volute	Mechanical cast iron EN GJL-250
Impeller	Mechanical cast iron EN GJL-200
Feet	Stainless Steel AISI304
Lower mechanical seal	Silicon carbide and alumina
Upper mechanical seal	Graphite and Alumina
Elastomers	NBR rubber
Cable	PBS8-F AD8





## PERFORMANCE CURVES

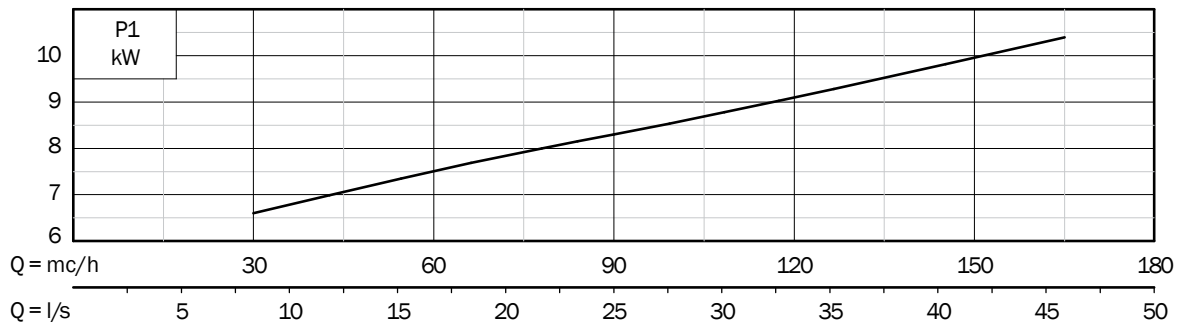
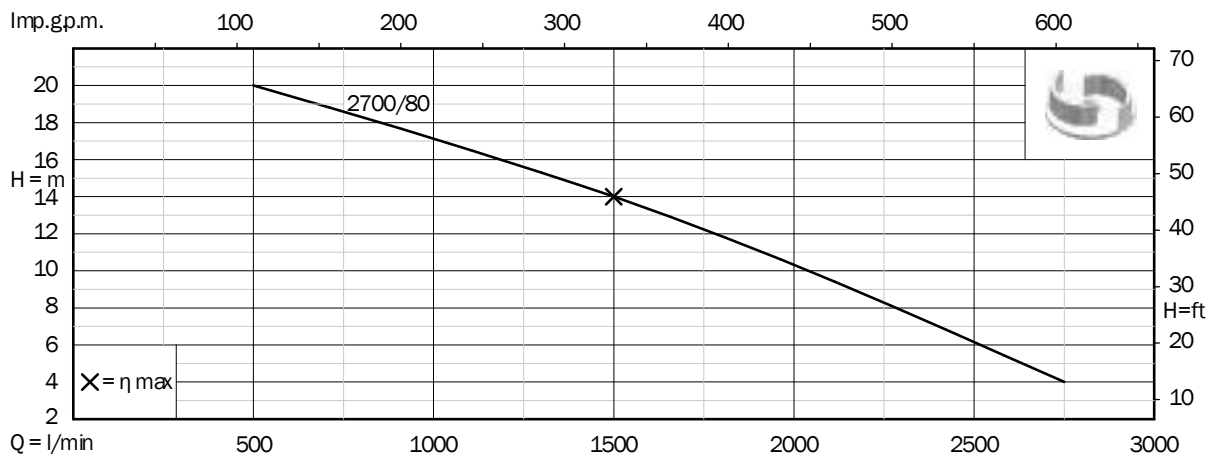
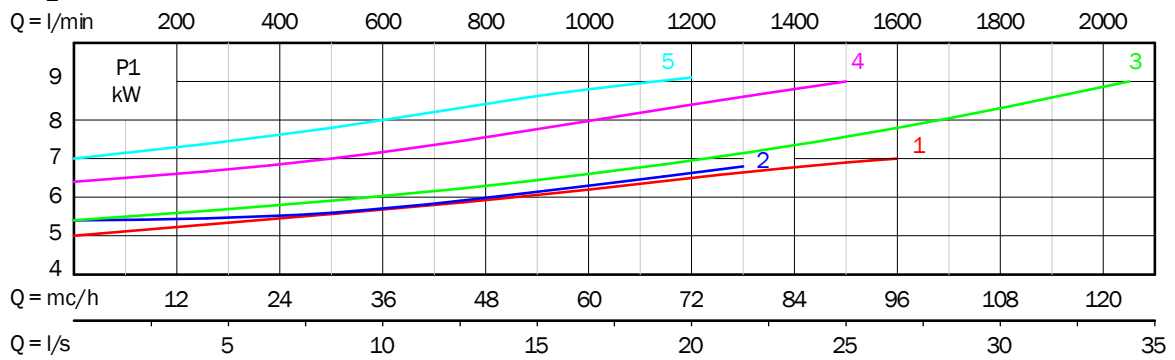
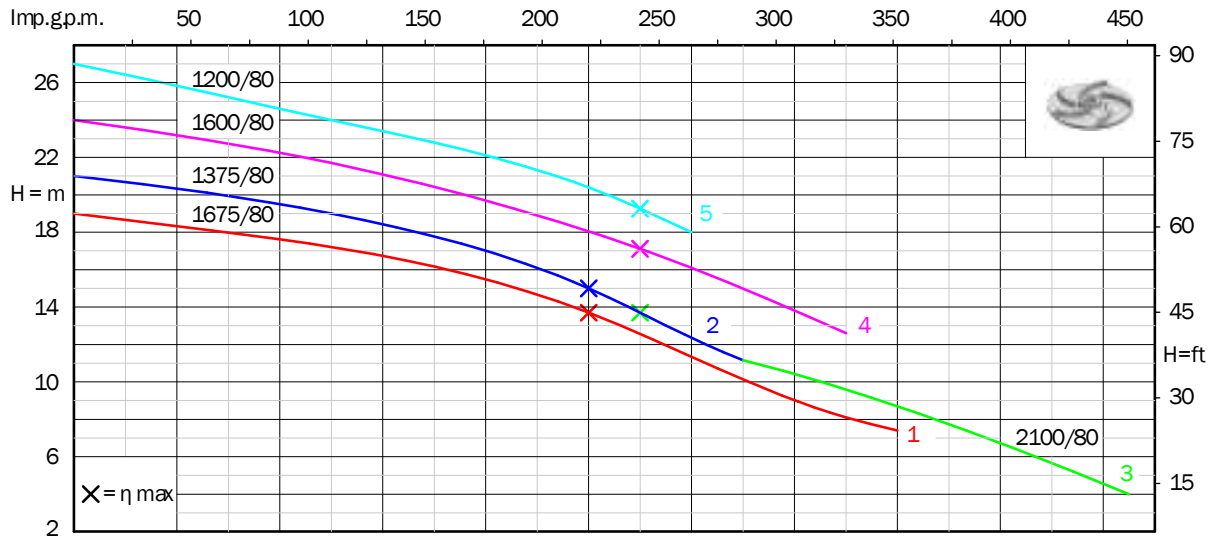

# Electric submersible pumps SEMISOM /80

for sewage water



## PERFORMANCE DATA - 2 poles 50 Hz

Vortex Impeller 	Code	Version		P2		P1	Max	Flow		Ø solid passage (mm)	Ø outlet (mm)	Dimensions (mm)				Weight kg
				hp	kW	kW		A	l/min			m	A	B	C	
SEMISOM 1555/80	ST/80/1555	400 V	3-phase	5,5	4	5,34	9,2	250 - 800 - 1500	13,5 - 10,6 - 4	74	80	703	78	383	295	65,5
SEMISOM 1255/80	ST/80/1255	400 V	3-phase	5,5	4	5,31	9,1	250 - 600 - 1200	14,6 - 13,2 - 7,7	74	80	703	78	383	295	65,5
SEMISOM 1055/80	ST/80/1055	400 V	3-phase	5,5	4	5,41	9,2	250 - 500 - 1000	16,4 - 15,5 - 11,4	74	80	703	78	383	295	65,5
SEMISOM 1775/80	ST/80/1775	400 V	3-phase	7,5	5,5	6,8	11,9	250 - 1200 - 1800	16,4 - 9,1 - 4,4	74	80	733	78	383	295	69
SEMISOM 1675/80	ST/80/1675	400 V	3-phase	7,5	5,5	7	12	250 - 1000 - 1600	18,2 - 13,7 - 7,4	74	80	733	78	383	295	69
SEMISOM 1375/80	ST/80/1375	400 V	3-phase	7,5	5,5	6,8	11,9	250 - 800 - 1300	20 - 16,8 - 11,6	74	80	733	78	383	295	69
SEMISOM 2100/80	ST/80/2100	400 V	3-phase	10	7,5	9	16,2	250 - 1300 - 2050	20 - 11,6 - 4	74	80	758	78	383	295	71
SEMISOM 1600/80	ST/80/1600	400 V	3-phase	10	7,5	9	16,2	250 - 1000 - 1500	23 - 18,3 - 12,6	74	80	758	78	383	295	71
SEMISOM 1200/80	ST/80/1200	400 V	3-phase	10	7,5	9,1	16,4	250 - 800 - 1200	25,4 - 22 - 18	74	80	758	78	383	295	71

P1: Max. absorbed power - P2: Nominal power of the motor

## PERFORMANCE DATA - 4 poles 50 Hz

Vortex Impeller 	Code	Version		P2		P1	Max	Flow		Ø solid passage (mm)	Ø outlet (mm)	Dimensions (mm)				Weight kg
				hp	kW	kW		A	l/min			m	A	B	C	
SEMISOM 1504/80	ST/80/1504	400 V	3-phase	3,5	2,6	3,64	8,2	200 - 1000 - 1600	9,3 - 6,8 - 3,9	74	80	758	78	383	295	71

P1: Max. absorbed power - P2: Nominal power of the motor

## PERFORMANCE DATA - 2 poles 50 Hz

Channel impeller 	Code	Version		P2		P1	Max	Flow		solid passage (mm)	Ø outlet (mm)	Dimensions (mm)				Weight kg
				hp	kW	kW		A	l/min			m	A	B	C	
SEMISOM 2700/80	ST/80/2700	400 V	3-phase	11	8	10,4	18	500 - 1500 - 2750	20 - 14 - 4	45x62	80	758	78	383	295	71

P1: Max. absorbed power - P2: Nominal power of the motor



### SUPPLIED WITH

10 meters power cable



Micro thermostat to protect the motor from overheating to be wired to the protection/control panel (type QT-MT - AM-AT)



Humidity probe to be wired to the protection/control panel (type ATS - AT2S)



UNI EN 1092-1  
DN80 PN10

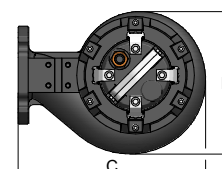
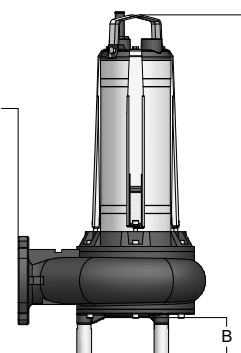

## ACCESSORIES

Code	Description
04105053	Guide rail kit inlet Ø80mm - outlet flange UNI EN 1092-1 DN80 PN16  (2" guide poles not included) 
Code	Description
04105054	Pump stand + screws 
Code	Description
04105049	Threaded flange inlet flange UNI EN 1092-1 DN80 PN10 - female threaded outlet G3" + screws and rubber packing 

## ILLUSTRATION OF AN INSTALLATION WITH GUIDE RAIL KIT

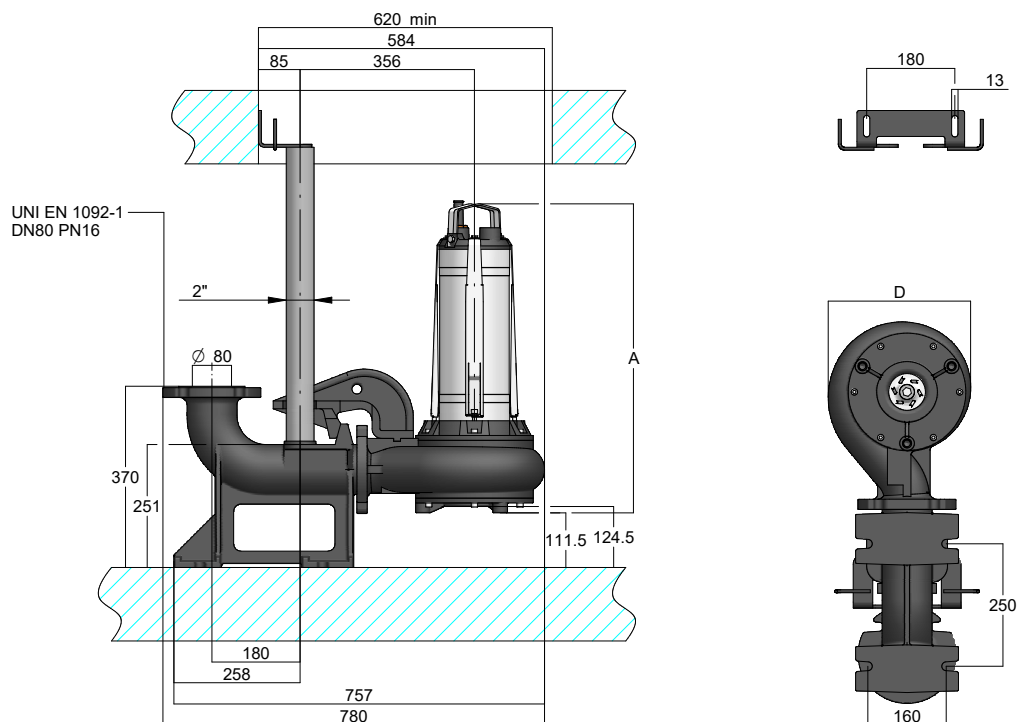

# Photovoltaic







# ECOSOM





## INTRODUCTION

ECOSOM solar stations are easy-to-install pumping units that can be used wherever there is good solar radiation. The solar panels supplied with both ECOSOM “E ” and “I” solar stations recharge the batteries thus to provide energy even when no solar light is available. ECOSOM “L ” solar stations can run exclusively with solar light since they use, directly, the energy coming from the solar panels. ECOSOM solar stations can be combined with electric pumps type SR (for clean water) or SEMISOM (for grey or sewage water), all equipped with 24V DC permanent magnets motors.

## APPLICATION

ECOSOM E - ECOSOM I			ECOSOM L		
ECOSOM 4/80	ECOSOM 190 - 320	ECOSOM 262 - 265	ECOSOM 4/80	ECOSOM 190 - 320	ECOSOM 262 - 265
To pump water from tanks, reservoirs and boreholes	To expel rain water and waste water coming from electric household appliances	To pump water from tanks, reservoirs even in case of solids	To pump water from tanks, reservoirs and boreholes	To pump water from tanks and reservoirs	To pump water from tanks, reservoirs even in case of solids
To pressurize civil and industrial plants	To drain tanks, cellars and garages	To expel rain water, waste and sewage water from septic tanks	Irrigation	To transfer water from pools and fountains	To transfer water from pools and fountains
Irrigation	To transfer water from pools and fountains	To transfer water from pools and fountains		Irrigation	Irrigation
	Irrigation	Surface irrigation			

## APPLICATION RANGE

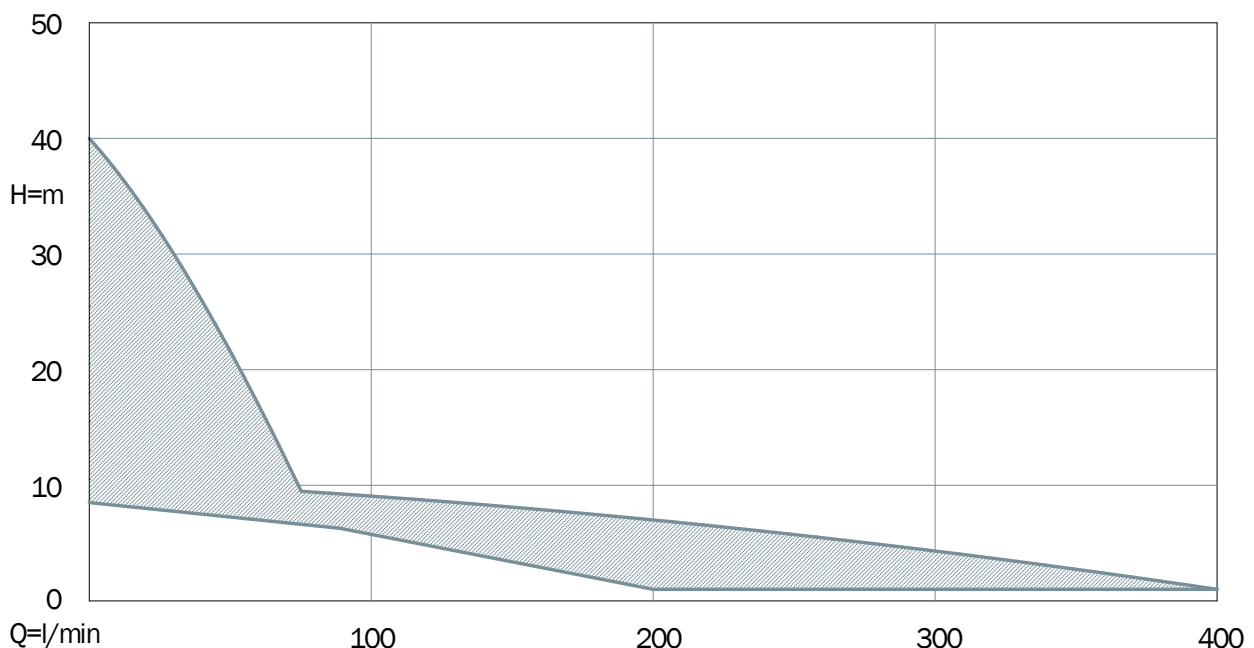

# ECOSOM solar pumping stations

## PERFORMANCE DATA ECOSOM for clean water

	Code			Available electric pumps					Q	Flow										
	Version E	Version I	Version L	Type	P2		P1	Max		Life of the batteries *	m <sup>3</sup> /h	0	0,36	0,6	1,2	1,8	2,4	3	3,6	4,2
					hp	kW	kW	A	min	l/min	0	6	10	20	30	40	50	60	70	80
<b>ECOSOM 4/80</b>	DE80/04E	DE80/04I	DE80/04L	SR 4/80 24 V DC	0,75	0,55	0,67	28	120	H (m)	40	38	37	34	30	26	21	17	11	7

\* only for "E" and "I" versions

## PERFORMANCE DATA ECOSOM for sewage water

	Code			Available electric pumps					Q	Flow										
	Version E	Version I	Version L	Type	P2		P1	Max		Life of the batteries *	m <sup>3</sup> /h	0	1,8	6	9	12	15	18	21	24
					hp	kW	kW	A	min	l/min	0	30	100	150	200	250	300	350	400	
<b>ECOSOM 190</b>	DE190E	DE190I	DE190L	SEMISOM 190 24 V DC	0,5	0,37	0,58	24	160	H (m)	10,5	9,5	7	4	1					
<b>ECOSOM 320</b>	DE320E	DE320I	DE320L	SEMISOM 320 24 V DC	0,75	0,55	0,67	28	120		11,5	11	9	7,5	5,5	3	0,5			
<b>ECOSOM 290</b>	DE290E	DE290I	DE290L	SEMISOM 290 24 V DC	0,75	0,55	0,67	28	120		8,5	8	7	6,5	5,5	4,5	3,5	2,5	1	
<b>ECOSOM 262</b>	DE262E	DE262I	DE262L	SEMISOM 262 24 V DC	0,75	0,55	0,67	28	120		10,5	10	9	8	7	6	4,5	3	1	

\* only for "E" and "I" versions

## AVAILABLE ELECTRIC PUMPS

	Code	Construction	Application / materials	Characteristics
SR 24 V Direct current	RF80/04/1	see page 11	see page 12	see page 16
SEMISOM 190 24 V Direct current	SF190	see page 105	see page 105	see page 109
SEMISOM 320 24 V Direct current	SF320	see page 105	see page 105	see page 109
SEMISOM 262 24 V Direct current	SF262	see page 113	see page 113	see page 119
SEMISOM 290 24 V Direct current	SF290	see page 113	see page 113	see page 118

## ECOSOM E with fibreglass cabinet for external installations

### CONTROL PANEL

#### CHARACTERISTICS

IP rating IP44

Ambient temperature -5/+40 °C

Suitable for external installation

Possibility of installing it to the base of the fixing frame

Easy-to-inspect battery location

Facility to wire float switches for dry running protection

Facility to wire pressure switch, stop and run float switch, etc.

#### MAIN COMPONENTS

Fibreglass cabinet

Hand - off - auto selector switch

30 A unipolar thermal protector switch

80 A power relay

Indicator light for: run - pump cut-out - low battery cut-out

20 A automatic charge controller to provide the correct power to the batteries

Fuse holder with fuses on both main and auxiliary circuit

### SOLAR MODULES

2 x 180 Wp (+/- 3%) monocrystalline silicon solar cells supplied with fixing bars and frame

### ELECTRIC WIRING

The pumping station is supplied with: all cables (pre-wired) for the electric connection of the solar modules, the control panel and the batteries

### ACCESSORIES

Code	Description
07210005	FRAME: designed for open-space, land installations with an angle of incidence at 30°. The installation is easy and quick and doesn't require particular tools. All components are in aluminium or stainless steel and their high resistance gives them a long life.
02086005	BATTERY 12 V 100 Ah: 100 Ah 12 V AGM Long-Life, monobloc, stationary Maintenance-free; 120 minutes life with no light (160 minutes for ECOSOM 190); 8 hours to charge them totally, with pump in stand-by.

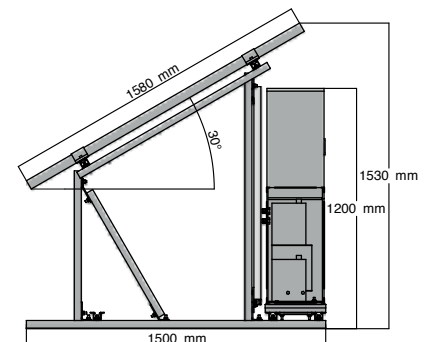
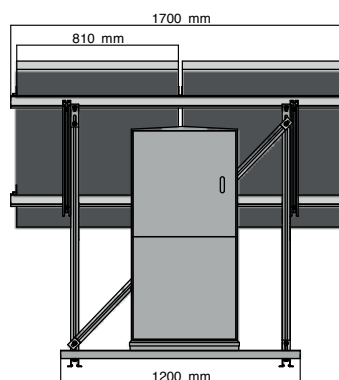

# ECOSOM solar pumping stations

## ECOSOM I with plastic panel

### CONTROL PANEL

#### CHARACTERISTICS

IP rating IP55

Ambient temperature -5/+40 °C

Suitable to be installed in sheltered places, away from solar beams

Facility to wire float switches for dry running protection

Facility to wire pressure switch, stop and run float switch, etc.

#### MAIN COMPONENTS

Plastic panel: 300 x 400 x 120 mm

Hand - off - auto selector switch

30 A unipolar thermal protector switch

80 A power relay

Indicator light for: run - pump cut-out - low battery cut-out

20 A automatic charge controller to provide the correct power to the batteries

Fuse holder with fuses on both main and auxiliary circuit

### SOLAR MODULES

2 x 180 Wp (+/- 3%) monocrystalline silicon solar cells supplied with fixing bars and frame

### ELECTRIC WIRING

The pumping station is supplied with: all cables (pre-wired) for the electric connection of the solar modules, the control panel and the batteries

### ACCESSORIES

Code	Description
07210005	<p><b>FRAME:</b> designed for open-space, land installations with an angle of incidence at 30°. The installation is easy and quick and doesn't require particular tools. All components are in aluminium or stainless steel and their high resistance gives them a long life.</p>
02086005	<p><b>BATTERY 12 V 100 Ah:</b> 100 Ah 12 V AGM Long-Life, monobloc, stationary Maintenance-free; 120 minutes life with no light (160 minutes for ECOSOM 190); 8 hours to charge them totally, with pump in stand-by.</p>



## ECOSOM L with plastic panel and without batteries

### CONTROL PANEL

### CHARACTERISTICS

IP rating IP65

Ambient temperature -5/+40 °C

Suitable to be installed in sheltered places, away from solar beams

Facility for automatic device (ex: level control)

### MAIN COMPONENTS

Plastic panel: 220 x 300 x 120 mm

Hand - off - auto selector switch

Unipolar thermal protector switch to protect the electric pump from overload

Indicator light for pump running

### SUGGESTED SOLAR MODULES (NOT included)

Open circuit voltage (Voc) < 40 V

Maximum power voltage (Vmp) > 29 V

Required power to run the station:  
P1 of the electric pump + 30% (Max. 1000 Wp)



# IDROSOLAR





## INTRODUCTION

The solar stations IDROSOLAR allow pumping water from a well with complete autonomy and can be easily installed anywhere there is a good solar radiation. Using the sunlight, they can produce the energy required to run the electric pump.

The number of revolutions of the pump is continuously adapted to available radiation, thus maximizing the flow of the water pumped. (MPPT function: Maximum Power Point Tracking).

When radiation levels increase so do the revolutions of the pump and, consequently, the flow rises.

When the radiation decreases, (clouds passing by or different times of the day) the revolutions of the pump get lower and thus its flow. However, the system continues to supply water until the radiation falls below the minimum necessary operation point.

In addition, the system is completely protected against overvoltage, over current and lack of water.

## APPLICATION

To pump water from boreholes

Irrigation

## APPLICATION RANGE

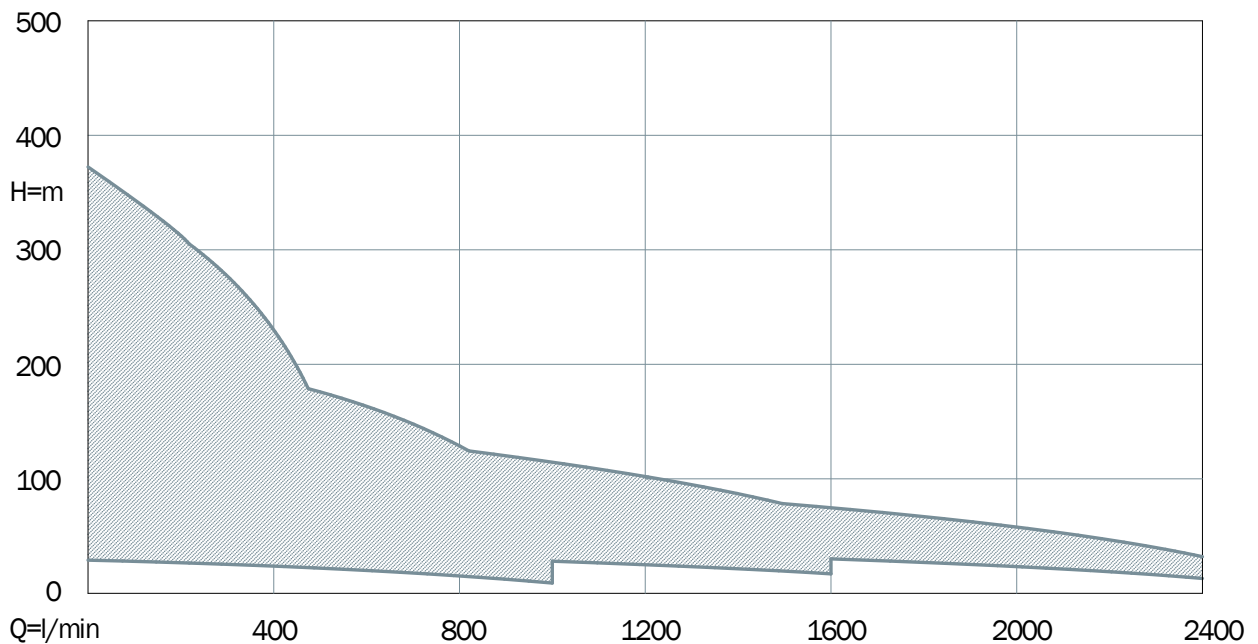

# Photovoltaic pumping stations IDROSOLAR

## PERFORMANCE CHARACTERISTICS

	Motor		Pump end				Suggested solar modules*		
	P2		H		Q		Number of strings	Modules each string	Total number of modules
	hp	kW	from	to	from	to			
			m		l/min				
IDROSOLAR 800	0,75	0,55	14	74	10	100	1	3	3
IDROSOLAR 1200	1	0,75	12	92	10	180	1	4	4
IDROSOLAR 1500	1,5	1,1	7	140	10	250	1	6	6
IDROSOLAR 2000	2	1,5	9	184	10	250	1	8	8
IDROSOLAR 3000	3	2,2	14	263	10	330	1	10	10
IDROSOLAR 3600	3,6	2,7	12	245	10	350	1	13	13
IDROSOLAR 5500	5,5	4	9	295	20	1000	1	18	18
IDROSOLAR 7500	7,5	5,5	13	223	75	1000	2	13	26
IDROSOLAR 10000	10	7,5	17	250	75	1600	2	18	36
IDROSOLAR 12500	12,5	9,2	23	307	90	1000	3	18	54
IDROSOLAR 15000	15	11	13	361	90	2400	3	19	57
IDROSOLAR 20000	20	15	34	323	150	1600	4	18	72
IDROSOLAR 25000	25	18,5	19	383	150	2400	4	19	76
IDROSOLAR 30000	30	22	26	290	200	2400	5	18	90
IDROSOLAR 40000	40	30	32	190	400	2400	7	18	126

\* The above calculations have been made considering solar panels with the following specifications

- Open circuit voltage (Voc) < 44 V
- Maximum power voltage (Vmp) > 32 V
- Maximum power current (Imp) < 10 A
- Maximum power rating (Pmax) ≥ 300 Wp

## PUMP TYPE COMBINATIONS

	Construction	Application/materials
Electric submersible pumps IDROSOM for 4" boreholes	see page 35	see page 36 - 37
Electric submersible pumps IDROSAND for 6" boreholes	see page 49	see page 50 - 51
Electric submersible pumps for 8" boreholes	see page 67	see page 68 - 69

## AVAILABLE VERSIONS

	IDROSOLAR	IDROSOLAR L	IDROSOLAR C
			

### CHARACTERISTICS

Motors power	from 0,75 to 40 hp	from 3 to 3,6 hp	from 0,75 to 2 hp
IP rating	IP54	IP65	IP65
Ambient temperature	-5/+40 °C	-5/+60 °C	-10/+50 °C
N° facilities for wiring a pump controller	1	1	1
Dimensions (mm)	from 500 x 430 x 210 to 1060 x 810 x 355	300 x 400 x 190	350 x 440 x 100

### MAIN COMPONENTS

Connection box	Fibreglass	Plastic	Plastic
Inverter case	Powder coated, die-cast aluminium	Powder coated, die-cast aluminium	Powder coated, die-cast aluminium
Fixing system	Steel-sheet fixing bars	Steel-sheet fixing plate	Steel-sheet fixing plate
Hand - off - auto selector switch	YES	NO	NO
Buttons to start and stop the electric pump	YES	YES	YES
Display to set and check the electric pump	YES	YES	NO
Bluetooth communication	YES	YES	YES
General disconnector for the connection of the photovoltaic modules	YES (opening interlocked)	YES	YES
Surge protector for photovoltaic systems	YES	NO	NO
Protective fuses	YES	YES	YES
Led indicator lamps for run and alarm	YES	NO	NO

### OPTIONS

Version with dU/dt filters	YES	NO	NO
----------------------------	-----	----	----

## Related products

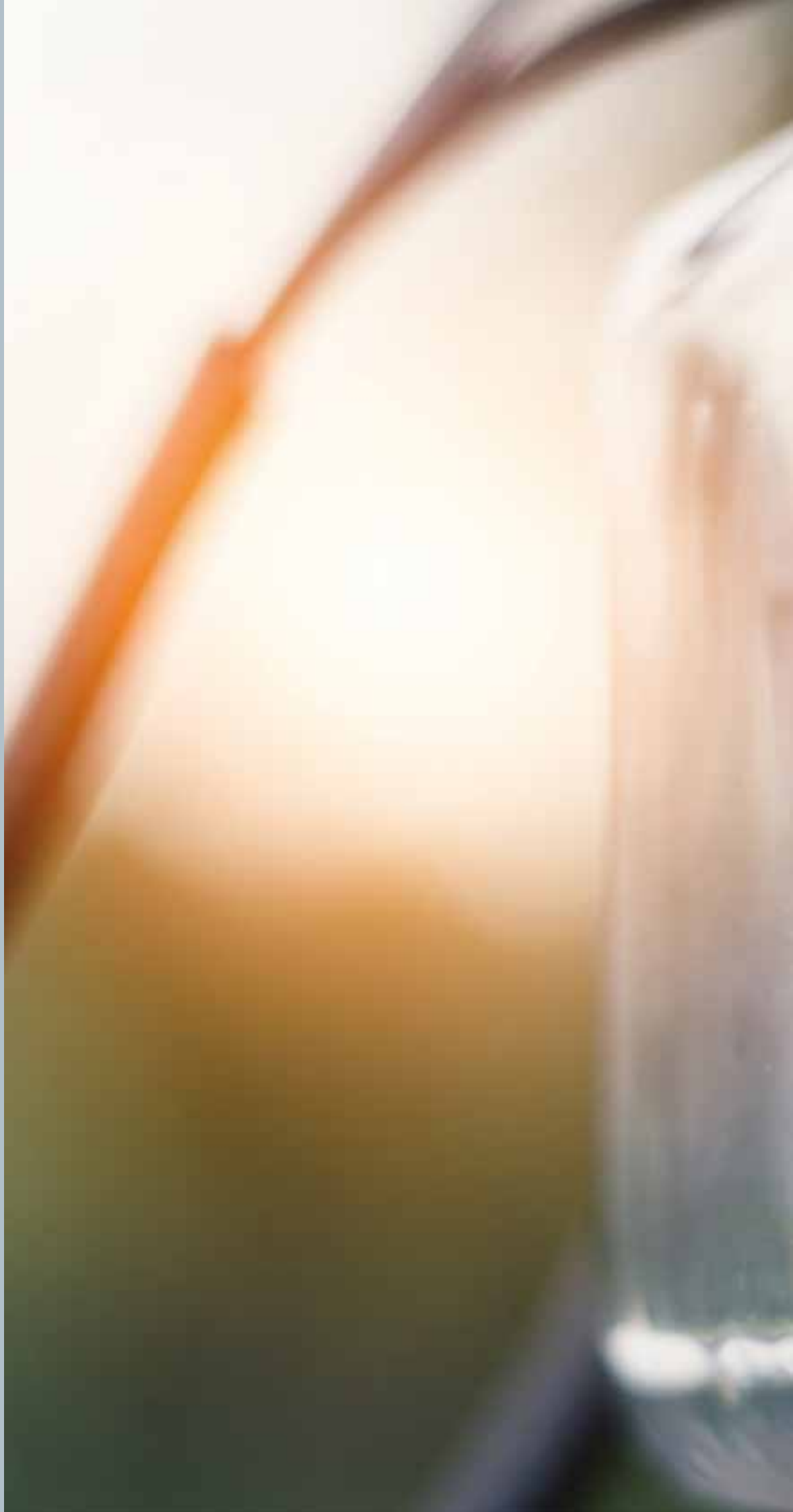



# Lifting station SEMIBOX

for sewage water

## APPLICATION

Suitable to collect and convey waste and sewage water

Advisable if the main sewer line is at a higher level than the collecting wet well

The lifting tank can be installed inside garages, basements or underground

## AVAILABLE WITH THE FOLLOWING ELECTRIC PUMPS

	Construction	Characteristics / materials	Performance
Domosom 250	see page 101	see page 101	see page 102
Semisom 290 VS	see page 113	see page 113	see page 118
Semisom 290 VA	see page 113	see page 113	see page 116
Semisom 390 VS	see page 113	see page 113	see page 118
Semisom 390 VA	see page 113	see page 113	see page 116
Semisom 125 GR	see page 129	see page 129	see page 130

## CHARACTERISTICS

Tank in high-density, corrosion-resistant polyethylene for either surface or underground installation. It is supplied with all necessary gaskets to fit inlet and outlet pipes as well as the ventilation hole.

The discharge pipe has simple release fittings to disconnect the electric pump, easily

The hermetically-sealed lid can be removed for inspecting the plant

Electric pump and tank can be coupled using a  $\varnothing$  50 mm or  $\varnothing$  63 mm pipe

Code	Description
06510026	Lifting station SEMIBOX 200 litres

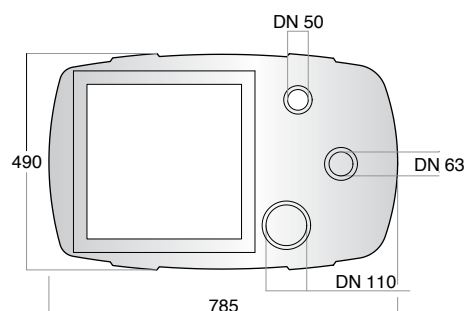
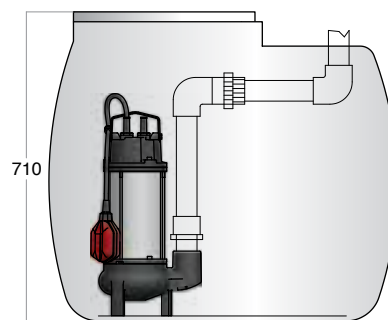



## ACCESSORIES

Code	Description
06520005	Connection kit electric pump Domosom/tank G1"½
06520010	Connection kit electric pump Semisom/tank G2"

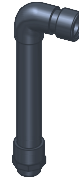

For electric pumps SEMISOM with vertical discharge

## EXAMPLE OF INSTALLATION

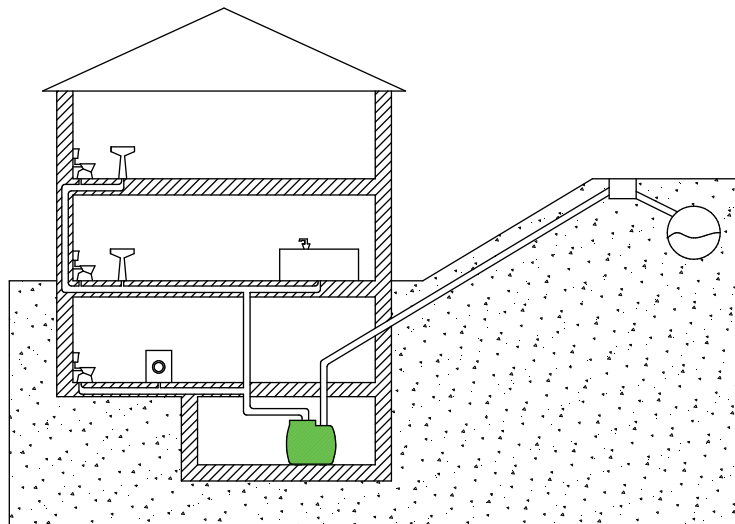

# Control and protection panels

## QM PT - Single-Phase direct starters

### CARATTERISTICHE

IP rating IP64

Ambient Temperature -5/+40 °C

N° 1 facility for wiring a pump controller (float switch, pressure switch, etc.), 1~230V

### MAIN COMPONENTS

Plastic panel

Unipolar thermal protector switch

Bipolar, illuminated switch



QM PT	Code	Approx. Power		A max	Dimensions mm
		hp	kW		
<b>Single-phase 230 V 50 Hz</b>					
QM PT 3	02069010	0,35 - 0,5	0,26 - 0,37	3	150 x 110 x 70
QM PT 5	02069020	0,5 - 0,75	0,37 - 0,55	5	
QM PT 7	02069030	0,9 - 1,1	0,65 - 0,8	7	
QM PT 10	02069040	1,3 - 1,6	0,95 - 1,2	10	

## QM IT - Single-Phase direct starters

### CHARACTERISTICS

IP rating IP40

Ambient Temperature -5/+40 °C

N° 1 facility for wiring a pump controller (float switch, pressure switch, etc.), 1~230V

### MAIN COMPONENTS

Plastic panel

Bipolar, illuminated thermal protector switch

### OPTIONS

Also available in IP55 rating



QM IT	Code	Approx. Power		A max	Dimensions mm
		hp	kW		
<b>Single-phase 230 V 50 Hz</b>					
QM IT 12	02070030	2	1,5	12	150 x 110 x 70
QM IT 18	02070035	3	2,2	18	

## QT MT - Three-phase Electromechanical direct starters

### CHARACTERISTICS

IP rating IP65

Ambient Temperature -5/+40 °C

N° 1 facility for wiring a pump controller (float switch, pressure switch, temperature sensor etc.)

N° 2 facilities for wiring stand and stop float switches

### MAIN COMPONENTS

Plastic panel

Bipolar, illuminated thermal protector switch

Run contactor

Low-voltage auxiliary circuits (24 V) with fuses

Lamp for pump running



QT MT	Code	Approx. Power		A min	A max	Dimensions mm
		hp	kW			
<b>Three-phase 400 V 50 Hz</b>						
QT MT 2,5	02081110	0,5 - 0,9	0,37 - 0,65	1,6	2,5	250 x 200 x 110
QT MT 4	02081120	1 - 1,6	0,75 - 1,2	2,5	4	
QT MT 6	02081130	2 - 3	1,5 - 2,2	4	6,3	
QT MT 10	02081140	4	3	6,3	10	

## QDC - Direct current Electromechanical direct starter

### CHARACTERISTICS

IP rating IP40
Ambient Temperature -5/+40 °C
N° 1 facility for wiring a pump controller (float switch, pressure switch, temperature sensor etc.)

### MAIN COMPONENTS

Plastic panel
Unipolar thermal protector switch
Power relay
Hand - off - auto selector switch
Lamp for pump running



QDC	Code	Approx. Power		A max	Dimensions mm
		hp	kW		
<b>24 V DC</b>					
QDC	02076100	0,5 - 0,75	0,37 - 0,55	30	190 x 140 x 70

## QM BT - Single-phase electronic starter with level control

### CHARACTERISTICS

IP rating IP40
Ambient Temperature -5/+40 °C
N° 1 facility for wiring a pump controller (float switch, pressure switch, temperature sensor etc.)
N° 3 facilities for wiring level probes (2 with switched timer) that can also be used with one or two float switches

### MAIN COMPONENTS

Plastic panel
Bipolar, illuminated thermal protector switch
Electronic level control
Led lights for: run - minimum level - cut-out
Low-voltage auxiliary circuits

### OPTIONS

Also available in IP55 rating
-------------------------------



QM BT	Code	Approx. Power		A max	Dimensions mm
		hp	kW		
<b>Single-phase 230 V 50 Hz</b>					
QM BT 3	02075003	0,35 - 0,5	0,26 - 0,37	3	190 x 140 x 70
QM BT 5	02075010	0,5 - 0,75	0,37 - 0,55	5	
QM BT 7	02075015	0,9 - 1,1	0,65 - 0,8	7	
QM BT 10	02075020	1,3 - 1,6	0,95 - 1,2	10	
QM BT 12	02075025	2	1,5	12	

## QT CL - Three-phase electromechanical direct starters with level control

### CHARACTERISTICS

IP rating IP65
Ambient Temperature -5/+40 °C
N° 1 facility for wiring a pump controller (float switch, pressure switch, temperature sensor etc.)
N° 3 facilities for wiring level probes that can also be used with one or two float switches

### MAIN COMPONENTS

Plastic panel
Circuit breaker
Run contactor
Low-voltage auxiliary circuit (24 V) with fuses
Electronic level control
Led lights for power and run



QT CL	Code	Approx. Power		A min	A max	Dimensions mm
		hp	kW			
<b>Three-phase 400 V 50 Hz</b>						
QT 2,5 CL	02081111	0,5 - 0,9	0,37 - 0,65	1,6	2,5	250 x 200 x 110
QT 4 CL	02081121	1 - 1,6	0,75 - 1,2	2,5	4	
QT 6 CL	02081131	2 - 3	1,5 - 2,2	4	6,3	
QT 10 CL	02081141	4	3	6,3	10	

# Control and protection panels

## AM - AT - Direct-on line starters for single and three-phase pumps with level control

### CHARACTERISTICS

IP rating IP55

Ambient Temperature -5/+40 °C

N° 1 facility for wiring a pump controller (float switch, pressure switch, temperature sensor etc.)

N° 3 facilities for wiring level probes that can also be used with one or two float switches

### MAIN COMPONENTS

Plastic panel

Opening interlocked

Run contactor

Low-voltage auxiliary circuit (24 V) with fuses

Thermal relay for motor protection

Set of fuses for motor protection

Electronic level control by means of a microprocessor

Hand - off - auto selector switch

Led lights for power and motor running, thermal cut-out and level cut-out



AM-AT-CL	Code	Approx. Power		A min	A max	Dimensions mm
		hp	kW			
<b>Single-phase 230 V 50 Hz</b>						
AM 20 CL	02080025	2	1,5	9	13	220 x 300 x 120
AM 30 CL	02080030	3	2,2	12	18	
<b>Three-phase 400 V 50 Hz</b>						
AT 55 CL	02081030	5,5	4	9	13	220 x 300 x 120
AT 75 CL	02081035	7,5	5,5	12	18	
AT 125 CL	02081040	10 - 12,5	7,5 - 9,2	17	25	
AT 150 CL	02081045	15	11	22	32	

## P2 BPA2 - P2 BPTA2 - Direct on line electromechanical single/three-phase starters for 2 electric pumps

### CHARACTERISTICS

IP rating IP55

Ambient Temperature -5/+40 °C

N° 3 facilities for wiring a start - stop alternate-duty-assist device (float switch, pressure switch, etc.)

N° 1 facility for maximum level alarm device

N° 1 Volt-free facility for alarm device

### MAIN COMPONENTS

Plastic panel

Opening interlocked

Low-voltage auxiliary circuit (24 V) with fuses

Run contactors

Thermal relays to protect the motors (in case of intervention, the stand-by pump is immediately turned ON)

Set of fuses for motor

Electronic circuit with microprocessor to control the alternate or simultaneous run of the electric pumps

Hand - off - auto selector switch

Led lights for: run P1 and P2 - thermal cut-out P1 and P2

### ACCESSORIES

Power failure alarm



P2 BPA2 - P2 BPTA2	Code	Approx. Power		A min	A max	Dimensions mm
		hp	kW			
<b>Single-phase 230 V 50 Hz</b>						
P2 BPA2 4	ZP2BPA2/1	0,5	0,37	2,5	4	300 x 380 x 120
P2 BPA2 6		0,75 - 1	0,55 - 0,75	4	6,3	
P2 BPA2 10		1,5	1,1	7	10	
P2 BPA2 13		2	1,5	9	13	
<b>Three-phase 400 V 50 Hz</b>						
P2 BPTA2 2	ZP2BPTA2/1	0,5	0,37	1,2	1,9	300 X 380 X 120
P2 BPTA2 2,5		0,75	0,55	1,6	2,5	
P2 BPTA2 4		1 - 1,5	0,75 - 1,1	2,5	4	
P2 BPTA2 6		2 - 3	1,5 - 2,2	4	6,3	
P2 BPTA2 10		4,5	3,4	7	10	

## ATI - Three-phase Inverter starters

### CHARACTERISTICS

IP rating IP40

Ambient Temperature -5/+40 °C

N° 2 facilities for wiring a pump controller (float switch, pressure switch, temperature sensor etc.)

N° 2 facilities for wiring start - stop float switches

N° 1 facility for wiring a pressure transducer 4÷20 mA 0÷10 bar

### MAIN COMPONENTS

Steel-sheet control panel

Opening interlocked

Low-voltage auxiliary circuits (24V) with fuses

Inverter with display, setting keyboard and internal fan

Set of fuses to protect the inverter

Hand - off - auto selector switches.

In Hand: using constant frequency (50 Hz) via pressure switch, float switch, etc.

In Auto: using variable frequency (30÷50 Hz) via pressure transducer 4÷20 mA 0÷10 bar

Lamps for: power - run - alarm - level cut-out

### OPTIONS

Version with level control

### ACCESSORIES

Pressure trasducer



ATI	Code	Approx. Power		A max	Dimensions mm
		hp	kW		
<b>Single-Phase line 230 V 50 Hz - Three-phase motor 230 V 50 Hz</b>					
ATI 230 10	02077010	1	0,75	4,2	300 x 400 x 200
ATI 230 20	02077020	1 - 2	0,75 - 1,5	6,8	
ATI 230 30	02077030	2 - 3	1,5 - 2,2	9,6	400 x 600 x 250
<b>Three-phase line 400 V 50 Hz - Three-phase motor 400 V 50 Hz</b>					
ATI 400 10	02078010	1	0,75	2,2	300 x 400 x 200
ATI 400 20	02078020	1 - 2	0,75 - 1,5	3,7	
ATI 400 30	02078030	2 - 3	1,5 - 2,2	5,3	
ATI 400 40	02078040	3 - 4	2,2	7,2	400 x 600 x 250
ATI 400 55	02078050	4 - 5,5	3 - 4	9	
ATI 400 75	02078060	5,5 - 7,5	4 - 5,5	12	
ATI 400 100	02078070	7,5 - 10	5,5 - 7,5	15,5	

## ATRS - Three-phase soft starters

### CHARACTERISTICS

IP rating IP55

Ambient Temperature -5/+40 °C

N° 1 facility for wiring a pump controller (float switch, pressure switch, temperature sensor etc.)

N° 2 facilities for wiring start - stop float switches

### MAIN COMPONENTS

Steel-sheet control panel

Opening interlocked

Low-voltage auxiliary circuits (24V) with fuses

Set of fuses to protect the motor

Hand - off - auto selector switch

Lamps for: power - run - thermal cut-out - level cut-out

### OPTIONS

Version with level control



ATRS	Code	Approx. Power		A min	A max	Dimensions mm
		hp	kW			
<b>Three-phase 400 V 50 Hz</b>						
ATRS 10	02079010	7,5 - 12,5	5,5 - 9,2	12	25	300 x 400 x 200
ATRS 15	02079015	15	11	14	32	
ATRS 20	02079020	20	15	18	37	400 x 600 x 250
ATRS 25	02079030	25	18,5	23	45	
ATRS 35	02079050	30 - 35	22 - 26	30	60	
ATRS 40	02079060	40	30	37,5	75	500 x 700 x 250
ATRS 50	02079070	50	37	42,5	85	
ATRS 60	02079080	60	45	60	115	600 x 800 x 300
ATRS 75	02079090	75	55	70	142	

# Control and protection panels

## ATS - Direct-on-line electromechanical three-phase starters for electric pumps Semisom/80

### CHARACTERISTICS

IP rating IP55
Ambient Temperature -5/+40 °C
N° 1 facility for wiring the humidity probe of the first chamber
N° 1 facility for wiring the temperature sensor
N° 1 facility for wiring a pump controller (float switch, pressure switch, temperature sensor etc.)
N° 2 facilities for wiring start – stop float switches
N° 1 facility for maximum level float switch
N° 1 facility for 24 V AC alarm device

### MAIN COMPONENTS

Steel-sheet control panel
Opening interlocked
Low-voltage (24 V) auxiliary circuits with fuses
Run contactor
Thermal relay for motor protection
Relay to control motor overheating
Set of fuses to protect the motor
Electronic control in case of humidity in the first chamber
Hand - off - auto selector switch
Lamps for: power - run - thermal cut-out - cut-out for motor overheating - cut-out for humidity in the first chamber - maximum level cut-out



ATS	Code	Approx. Power		A min	A max	Dimensions mm
		hp	kW			
<b>Three-phase 400 V 50 Hz</b>						
ATS 55	02082010	3,5 - 5,5	2,6 - 4	7	10	300 x 400 x 150
ATS 100	02082020	7,5 - 10	5,5 - 7,5	12	18	
ATS 110	02082030	11	8	17	25	

## AT2S - Direct-on-line electromechanical three-phase starters for 2 electric pumps Semisom/80

### CHARACTERISTICS

IP rating IP55
Ambient Temperature -5/+40 °C
N° 2 facilities to wire the humidity probes of the first chamber
N° 2 facilities for wiring the temperature sensors
N° 3 facilities for wiring a start - stop alternate-duty-assist device (float switch, pressure switch, etc.)
N° 1 facility for maximum level alarm device
N° 1 Volt-free facility for alarm device

### MAIN COMPONENTS

Steel-sheet control panel
Opening interlocked
Low-voltage (24 V) auxiliary circuits with fuses
Run contactors
Thermal relays for motor protection
Relays to control motor overheating
Set of fuses to protect the motor
Electronic control in case of humidity in the first chambers
Hand - off - auto selector switches
Electronic circuit with microprocessor to control the alternate or simultaneous run of the electric pumps
Lamps for: power - pump 1 - pump 2 - thermal cut-out - cut-out for motor overheating - cut our for humidity in the first chamber



### ACCESSORIES

Power failure alarm

AT2S	Code	Approx. Power		A min	A max	Dimensions mm
		hp	kW			
<b>Three-phase 400 V 50 Hz</b>						
AT2S 55	02082110	3,5 - 5,5	2,6 - 4	7	10	400 x 600 x 200
AT2S 100	02082120	7,5 - 10	5,5 - 7,5	12	18	
AT2S 110	02082130	11	8	17	25	



## QA 12 - Power failure alarm

### CHARACTERISTICS

IP rating IP40

Ambient Temperature -5/+40 °C

N° 1 facility for Volt-free alarm device

12 hour-life battery

### MAIN COMPONENTS

Plastic panel

On - off - test selector switch

102 db/1m acoustic alarm

Led visual alarm

230 V battery charger supplied with 6 V nickel cadmium battery



QA 12	Code	Dimensions
		mm
QA 12	02064030	190 x 140 x 70

# Accessories

## Non-return valves



Code	Description
05405031	Non-return valve 1"½ GAS threaded
05405035	Non-return valve 2" GAS threaded

Code	Description
05430010	Non-return ball valve 1"½ GAS
05430015	Non-return ball valve 2" GAS
05430020	Non-return ball valve 2"½ GAS threaded
05430110	Non-return ball valve DN80 PN16 threaded

## Electrodes



### CHARACTERISTICS

Plastic material

Conductance probe in stainless steel AISI304

Suitable for cables up to 2,5 mm<sup>2</sup>

Code	Description
03605011	Electric probe ESU E
01901016	Cable for probes 1 x 1,5 mm <sup>2</sup>

## Float switches



### CHARACTERISTICS

Cable size 3 x 1 mm<sup>2</sup>

IP rating IP68

Dual function (emptying and filling)

10 (4) A switch

Code	Description
02034045	Float switch 2 m PVC
02034060	Float switch 5 m PVC
02034040	Float switch 10 m PVC
02034042	Float switch 15 m PVC
02034050	Float switch 20 m PVC

Code	Description
02034015	Float switch for sewage water 5 m PVC
02034005	Float switch for sewage water 10 m PVC

Code	Description
03105005	Counterweight for float switch

## Start and control devices



### CARATTERISTICHE

Built-in pressure gauge
Adjustable start pressure from 1,5 to 3 bar
Maximum allowed pressure 10 bar
Dry running protection with automatic reset
Anti-blocking function
Power up to 1,5 kW single-phase 230 V 50 Hz
Hydraulic inlet and outlet G1" male

Code	Description
06605040	Pressure flow regulator

## Capacitors



### CHARACTERISTICS

450 V 3000 h continuous duty

Code	Description
02008005	Capacitor 10 $\mu$ F
02008015	Capacitor 12,5 $\mu$ F
02008025	Capacitor 16 $\mu$ F
02008030	Capacitor 20 $\mu$ F
02008040	Capacitor 25 $\mu$ F
02008045	Capacitor 31,5 $\mu$ F
02008050	Capacitor 35 $\mu$ F
02008055	Capacitor 40 $\mu$ F
02008060	Capacitor 45 $\mu$ F
02008065	Capacitor 50 $\mu$ F
02008070	Capacitor 60 $\mu$ F

## Electric cables

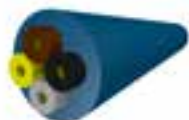
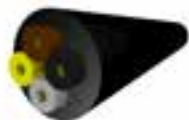

Code	Description
<b>Cables for permanent immersion</b>	
01902016	H07 RN8-F round cable 3 x 1 mm <sup>2</sup>
01902051	H07 RN8-F round cable 4 x 1 mm <sup>2</sup>
01902056	H07 RN8-F round cable 4 x 1,5 mm <sup>2</sup>
01906070	PVC AD8 round cable 4 x 1,5 mm <sup>2</sup> + 2 x 0,75 mm <sup>2</sup>
01906090	PVC AD8 round cable 4 x 2,5 mm <sup>2</sup> + 3 x 0,75 mm <sup>2</sup>
<b>Cables for permanent immersion in drinking water</b>	
01906050	PVC ACS AD8 round cable 4 x 1 mm <sup>2</sup>
01906060	PVC ACS AD8 round cable 4 x 1,5 mm <sup>2</sup>
<b>Cables for permanent immersion in drinking water</b>	
01922010	PVC ACS AD8 flat cable 4 x 1 mm <sup>2</sup>
01922011	PVC ACS AD8 flat cable 4 x 1,5 mm <sup>2</sup>
01922050	PVC ACS AD8 flat cable 4 x 4 mm <sup>2</sup>
01922055	PVC ACS AD8 flat cable 4 x 6 mm <sup>2</sup>

# Pressure lost chart

## Pressure loss in pipes for 100m run

Flow			Internal diameter of the pipe															
			gas	3/4"	1"	1" 1/4	1" 5/8	2"	2" 1/2	3" 1/8	4"	5"	6"	7"	8"	10"	12"	16"
l/sec	l/min	m <sup>3</sup> /h	mm	20	25	32	40	50	65	80	100	125	150	175	200	250	300	400
Pressure loss in meters of column of water																		
0,16	10	0,6		2,6	1	0,28	0,09											
0,25	15	0,9		6,5	2,15	0,6	0,18											
0,33	20	1,2		10	3,5	1	0,3	0,11										
0,41	25	1,5		15	5,5	1,6	0,5	0,16										
0,5	30	1,8		22	8	2,2	0,65	0,23										
0,66	40	2,4		40	13	4	1,2	0,4	0,1									
0,83	50	3		60	21	6	1,8	0,6	0,16									
1	60	3,6		75	28	8	2,4	0,85	0,22									
1,16	70	4,2			40	11,5	3,2	1,15	0,3	0,11								
1,33	80	4,8			54	14,5	4,5	1,5	0,4	0,14								
1,5	90	5,4			65	18	5,3	1,8	0,48	0,16								
1,66	100	6			77	22	6,5	2,2	0,52	0,2								
2	120	7,2				30	9	3	0,8	0,3								
2,33	140	8,4				42	12	4,2	1,1	0,38	0,13							
2,66	160	9,6				53	16	5,3	1,4	0,5	0,17							
3	180	10,8				65	20	6,5	1,7	0,6	0,21							
3,33	200	12				78	24	8	2,1	0,72	0,26							
3,66	220	13,2				90	26,5	9	2,4	0,84	0,3	0,1						
4	240	14,4					33	11,3	3	1,1	0,37	0,12						
4,33	260	15,6					40	13,5	3,5	1,22	0,43	0,14						
4,66	280	16,8					45	15	4	1,4	0,48	0,16						
5	300	18					51	17	4,5	1,6	0,51	0,18						
5,83	350	21					68	24	6	2,1	0,75	0,24						
6,66	400	24					87	29	7,8	2,65	0,95	0,31	0,12					
7,5	450	27						38	9,6	3,3	1,18	0,38	0,15					
8,33	500	30						45	11,8	4,2	1,4	0,47	0,18					
9,16	550	33						55	14	5	1,7	0,51	0,21	0,1				
10	600	36						64	16,5	5,5	2	0,65	0,25	0,12				
11,6	700	42						87	23	8	2,8	0,9	0,32	0,16				
13,3	800	48							30	10,5	3,5	1,18	0,44	0,21	0,11			
16,6	1000	60							44	15	5,3	1,8	0,65	0,31	0,16			
20	1200	72							62	22	7,5	2,5	0,95	0,45	0,22			
23,3	1400	84							81	28,5	10	3,25	1,25	0,6	0,3	0,1		
26,6	1600	96								37,5	13	4,3	1,6	0,78	0,38	0,13		
30	1800	108								46	16	5,3	2	0,95	0,47	0,16		
33,3	2000	120								56,5	19,5	6,5	2,4	1,15	0,58	0,19		
36,6	2200	132								65	23	7,7	2,9	1,38	0,7	0,23		
40	2400	144								75	27	9	3,3	1,6	0,81	0,27	0,11	
43,3	2600	156									32	10,7	4	1,9	0,98	0,32	0,13	
46,6	2800	168									37	12	4,5	2,2	1,1	0,37	0,15	
50	3000	180									42	14	5,25	2,45	1,22	0,42	0,17	
58,3	3500	210									56	18	6,8	3,25	1,65	0,55	0,22	
66,6	4000	240									73	24	8,8	4,25	2,15	0,7	0,29	
75	4500	270										30	11	5,4	2,7	0,9	0,37	
83,3	5000	300										37	14	6,6	3,3	1,1	0,45	0,11

### Notes

Pressure loss should be multiplied by:

- **0,65** for PVC pipes;
- **0,8** for new steel pipes;
- **1,25** for slightly rusty steel pipes;
- **1,7** for encrusted pipes.

## Single-phase 230 V 50 Hz

Motor nominal power		Cable section in mm <sup>2</sup>									
hp	kW	4x1	4x1,5	4x2,5	4x4	4x6	4x10	4x16	4x25	4x35	4x50
<b>Maximum cable length in meters</b>											
<b>0,5</b>	<b>0,37</b>	60	90	140	230	340					
<b>0,75</b>	<b>0,55</b>	40	70	110	190	280	470				
<b>1</b>	<b>0,75</b>	35	55	85	135	200	335	525			
<b>1,2</b>	<b>0,9</b>	30	50	80	120	180	300	470			
<b>1,5</b>	<b>1,1</b>	25	40	60	100	150	250	395			
<b>2</b>	<b>1,5</b>		35	50	80	120	190	300	470		
<b>3</b>	<b>2,2</b>			30	50	70	120	190	300	405	

## Three-phase 400 V 50 Hz

Motor nominal power		Cable section in mm <sup>2</sup>									
hp	kW	4x1	4x1,5	4x2,5	4x4	4x6	4x10	4x16	4x25	4x35	4x50
<b>Maximum cable length in meters</b>											
<b>0,5</b>	<b>0,37</b>	220	340	550							
<b>0,75</b>	<b>0,55</b>	200	300	480	770						
<b>1</b>	<b>0,75</b>	150	230	370	600						
<b>1,2</b>	<b>0,9</b>	130	210	330	530						
<b>1,5</b>	<b>1,1</b>	100	180	290	470						
<b>2</b>	<b>1,5</b>	80	140	220	360	540					
<b>3</b>	<b>2,2</b>	60	100	160	260	390	650				
<b>4</b>	<b>3</b>	45	75	120	200	300	500				
<b>5,5</b>	<b>4</b>		55	90	150	220	370	590			
<b>7,5</b>	<b>5,5</b>		40	70	115	170	285	450			
<b>10</b>	<b>7,5</b>			60	90	140	230	360	560		
<b>12,5</b>	<b>9,2</b>				75	115	190	300	470		
<b>15</b>	<b>11</b>				60	90	155	245	380	520	
<b>20</b>	<b>15</b>					60	110	170	260	360	480
<b>25</b>	<b>18</b>						90	140	220	300	395
<b>30</b>	<b>22</b>						75	120	185	250	320
<b>35</b>	<b>26</b>							105	160	215	285
<b>40</b>	<b>30</b>							90	145	200	260
<b>50</b>	<b>37</b>								110	155	200
<b>60</b>	<b>45</b>									130	170
<b>75</b>	<b>55</b>										140

### Note

Voltage drop:

- 3 %

Maximum ambient temperature:

- 30 °C





Concept and Art Direction -  
Digital post production -  
**Studiopieri** Web & Graphic Agency

Technical features, dimensions and all  
other data in this catalogue are not binding.  
The manufacturer reserves the right to make any  
necessary modifications without prior notice.

**November 2021 - Cod 001 - Rev 016**

Performances according to  
EN ISO 9906:2012 - grade 3B



Via G. Di Vittorio, 9  
61034 Fossombrone (PU) - Italy  
Tel. + 39 0721 716590  
Fax + 39 0721 716518  
bbcpompe@bbc.it - [www.bbc.it](http://www.bbc.it)