

Made in Italy

60

2018

PRODUCT
CATALOGUE

 **BBC**
ELETTROPOMPE®

BBC underwater world



Made in Italy





The aim of the Company, founded in **1959**, is to design, manufacture and deal with efficient and reliable electric pumps that can stand even the most severe applications. The experience achieved in this long period is daily exploited in the pursuit of materials, suppliers, new working and assembling methods so to preserve a high level of quality.

The balance between innovating and traditional principles together with the use of trustworthy components makes our products appreciated in the most different areas and markets.

An important achievement on the way both of growth and consolidation of our structure, has been, in 1997,

the certification of our Quality System according to **UNI EN ISO 9001** standards. Consequently, a deliberate acceptance of these international criteria is intended as a natural evolution towards a continuous enhancement.

Clean water

p.6

**Electric submersible pumps
TURBOSOM**
for 6" boreholes



p.66

Electric submersible pumps
for 8" boreholes



p.10

**Electric submersible pumps
SR**
for tanks and reservoirs



p.76

**External electric pumps
CMO**
horizontal multistage



p.34

**Electric submersible pumps
IDROSOM**
for 4" boreholes



p.80

**External electric pumps
CV**
vertical multistage



p.48

**Electric submersible pumps
IDROSAND**
for 6" boreholes



p.94

**Automatic
booster sets**



Photovoltaic

p.146

**Photovoltaic
pumping stations
ECOSOM**



p.152

**Photovoltaic
pumping stations
IDROSOLAR**



Dirty water

p.100

**Electric submersible pumps
SEMISOM**
for grey water



p.126

**Electric submersible pumps
SEMISOM GR**
for sewage water with grinder



p.108

**Electric submersible pumps
SEMISOM**
for sewage water



p.130

**Electric submersible pumps
SEMISOM /50 - /65**
for sewage water



p.124

**Automatic lifting station
SEMIBOX**
for sewage water



p.138

**Electric submersible pumps
SEMISOM /80**
for sewage water



Panels and Accessories

p.158

**Protection
and control panels**



p.164

Accessories



p.166

**Pressure loss
Selection of cables**

Clean water





TURBOSOM 6"



Electric submersible peripheral pumps TURBOSOM for 6" boreholes



APPLICATION

To pump clear water from boreholes

To pressurize civil plants

Irrigation

APPLICATION FEATURES

| | |
|---|---------------------------|
| IP rating | IP68 |
| Duty | Continuous S1 |
| Max number of starts per hour | 40 |
| Max temperature of the liquid pumped (°C) | 50 |
| PH of the liquid pumped | 6 - 10 |
| Maximum sand content (g/m ³) | 20 |
| Suitable for inverter drive | Three-phase versions only |
| Suitable to operate horizontally | |

APPLICATION RANGE

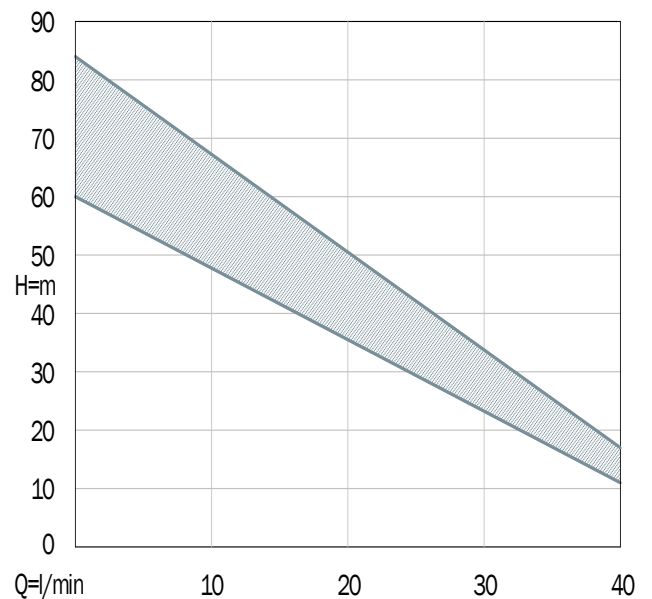

CONSTRUCTION

Single-stage pump with peripheral impeller

Coolant filled, asynchronous, rewindable electric AC motor with short circuit rotor. Insulation Class F

Resin-insulated cable kit to prevent penetration of water inside the motor

MATERIALS

| | |
|---------------------------|---------------------------------|
| Motor casing and tie-rods | Stainless Steel AISI304 |
| Shaft | Stainless Steel AISI420B |
| Impeller, bolts and nuts | Brass OT58 |
| Head, body and foot | Mechanical cast iron EN GJL-250 |
| Seal rings | NBR rubber |
| Elastomers | NBR rubber |
| Cable | H07RN8-F Neoprene |

Electric submersible peripheral pumps TURBOSOM

for 6" boreholes

PERFORMANCE DATA - 2 poles 50 Hz

| Peripheral impeller  | Code | Version | | P2 | | | | DNM | Q m ³ /h l/min | Flow | | | | | | | Dimensions (mm) | | | Weight kg |
|---|-------|---------|---------|------|------|-----|----|-----|---------------------------------|------|------|------|------|-----|-----|-----|-----------------|-----|-----|--------------|
| | | | | hp | kW | A | μF | | | 0 | 0,36 | 0,72 | 1,08 | 1,5 | 1,8 | 2,4 | A | B | C | |
| | | | | | | | | | | | | | | | | | | | | |
| TURBOSOM 57 | TM057 | 230 V | 1-phase | 0,75 | 0,55 | 3,8 | 16 | 1" | H (m) | 60 | 54 | 48 | 40 | 31 | 25 | 11 | 334 | 236 | 136 | 12,6 |
| | TT057 | 400 V | 3-phase | | | 1,6 | | | | | 12,6 | | | | | | | | | |
| TURBOSOM 77 | TM077 | 230 V | 1-phase | 1 | 0,75 | 6 | 20 | 1" | H (m) | 84 | 75 | 66 | 56 | 44 | 35 | 17 | 349 | 251 | 136 | 14 |
| | TT077 | 400 V | 3-phase | | | 2,3 | | | | | 13,7 | | | | | | | | | |

SUPPLIED WITH

10 meters power cable



Control box containing capacitor and unipolar thermal protector switch (single-phase version)



OPTIONS

20 meters power cable



30 meters power cable

ACCESORIES

| Code | Description |
|----------|--|
| 020811.. | Three-phase electromechanical direct starter QT MT |

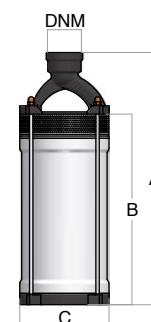

PERFORMANCE CURVES - 2 poles 50 Hz

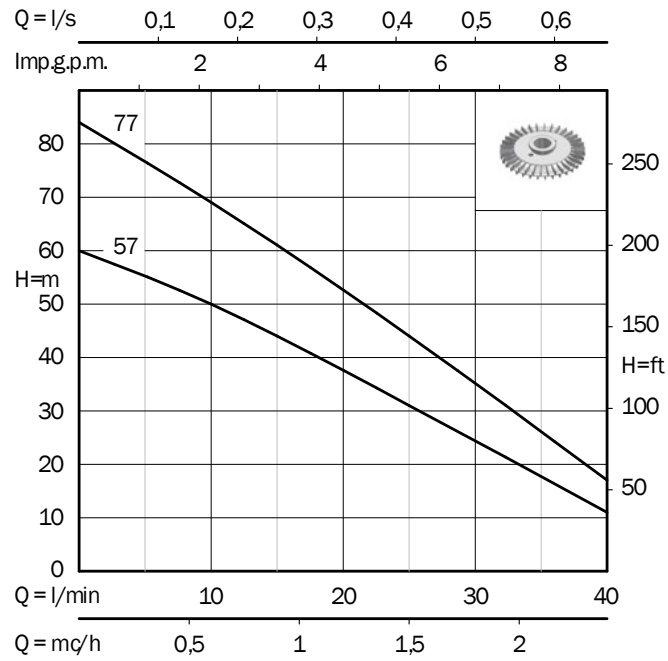

SR



Electric submersible pumps SR

for tanks and reservoirs



APPLICATION

To pump water from tanks, reservoirs and boreholes

To pressurize civil, agricultural, industrial and fire-fighting plants

Irrigation

CONSTRUCTION

Series SR 100 - 140: AC asynchronous, rewindable electric dry motor with short circuit rotor with double mechanical seal and oil chamber in-between. Insulation Class F

Series SR 200 - 300: AC asynchronous, rewindable electric dry motor with short circuit rotor with double mechanical seal and oil chamber in-between. Insulation Class F; lubrication chamber for the ball bearing on the pump side

Series SR 230 - 330 - 400 - 700: Coolant filled, asynchronous, rewindable electric AC motor with short circuit rotor Insulation Class F

Series SR 80: 24V DC with permanent magnets motor. Insulation Class F

Resin-insulated cable kit to prevent penetration of water inside the motor

APPLICATION RANGE

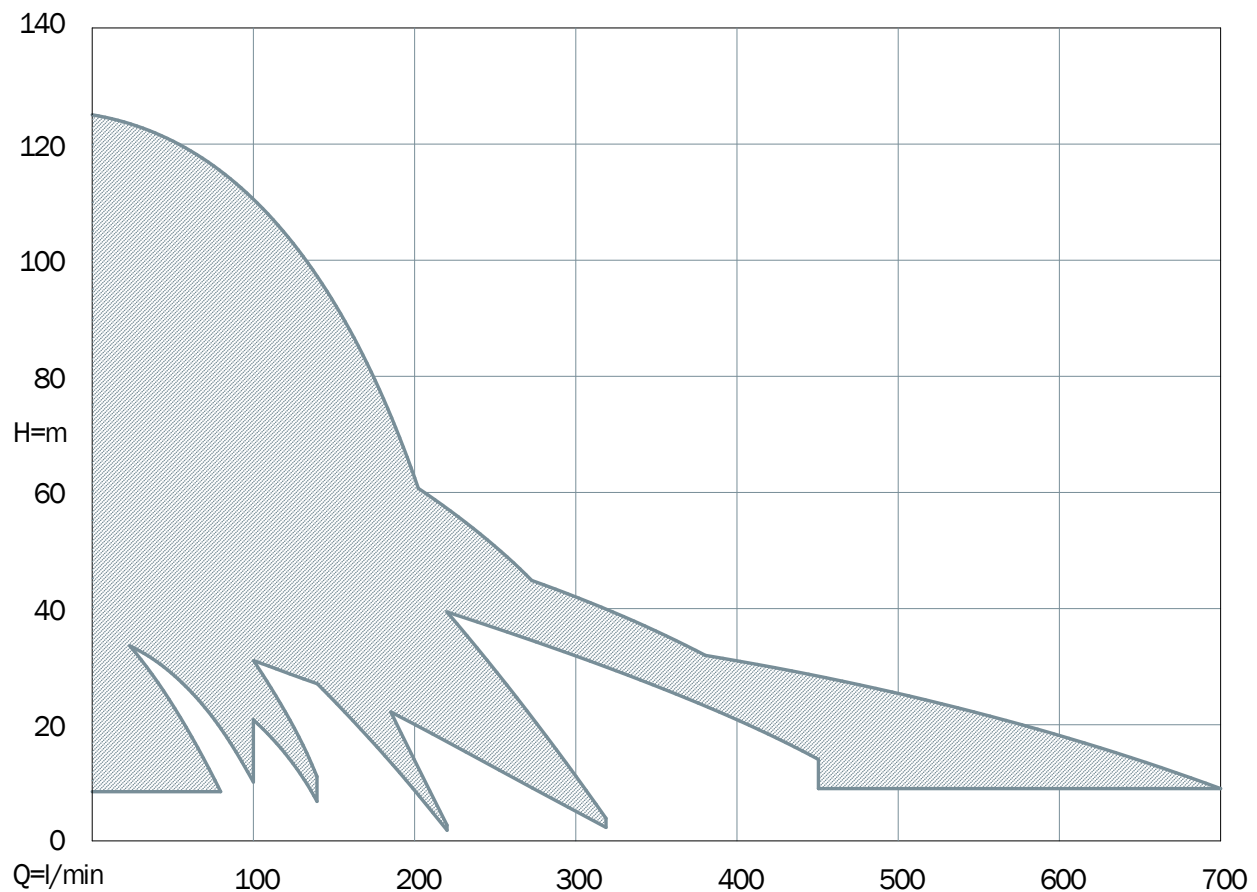

Electric submersible pumps SR

for tanks and reservoirs



This important certification, released by an Agency accredited by the French Ministry of Health, attests that the electric pumps series SR -/100 /140 /200 /300 can be used to pump drinkable water.

APPLICATION FEATURES

| | SR | | |
|---|---------------------------|------|-----------------------------|
| | /100 | /140 | /80 |
| IP rating | IP68 | | |
| Duty | Continuous S1 | | Limited use S2 (60 minutes) |
| Minimum level of the liquid to be pumped (mm) | 100 | | |
| Maximum immersion depth (m) | 30 | | |
| Max number of starts per hour | 40 | | |
| Max temperature of the liquid pumped (°C) | 45 | | |
| PH of the liquid pumped | 6 - 10 | | |
| Maximum sand content (g/m ³) | 50 | | |
| Suitable for inverter drive | Three-phase versions only | | |

MATERIALS

| | SR | | |
|---|---|------|-----------|
| | /100 | /140 | /80 |
| Discharge, motor cover and central body | Brass OT58 | | |
| External casing, handle, motor casing, bolts and nuts | Stainless Steel AISI304 | | |
| Shaft | Stainless Steel AISI420B | | |
| Impellers and diffusers | Noryl® reinforced with fibre-glass certified for drinkable water and Stainless Steel AISI304 wear rings | | |
| Foot | Stainless Steel AISI304 | | |
| Mechanical seal | Silicon carbide and alumina | | |
| Elastomers | NBR rubber | | |
| Cable | PVC ACS AD8 (for permanent immersion in drinking water) | | Twin Batt |

APPLICATION FEATURES

| | SR | | | | | |
|---|---------------------------|------|------|------|------|------|
| | /200 | /300 | /230 | /330 | /400 | /700 |
| IP rating | IP68 | | | | | |
| Duty | Continuous S1 | | | | | |
| Minimum level of the liquid to be pumped (mm) | 150 | 100 | | | 120 | |
| Maximum immersion depth (m) | 20 | 30 | | | | |
| Max number of starts per hour | 40 | 30 | | | | |
| Max temperature of the liquid pumped (°C) | 45 | | | | | |
| PH of the liquid pumped | 6 - 10 | | | | | |
| Maximum sand content (g/m ³) | 50 | 200 | | 300 | | |
| Suitable for inverter drive | Three-phase versions only | | | | | |

MATERIALS

| | SR | | | | | |
|---|---|------|--|------|---------------------------------|------|
| | /200 | /300 | /230 | /330 | /400 | /700 |
| Discharge, motor cover and central body | Brass OT58 | | Mechanical cast iron EN GJL-250 | | | |
| External casing, handle, motor casing, bolts and nuts | Stainless Steel AISI304 | | | | | |
| Shaft | Stainless Steel AISI420B | | Stainless Steel AISI420B - AISI303 | | | |
| Impellers and diffusers | Noryl® reinforced with fibre-glass certified for drinkable water and Stainless Steel AISI304 wear rings | | | | | |
| Body of the diffusers | | | | | Mechanical cast iron EN GJL-200 | |
| Bearing of the diffusers | | | | | Anti-sand rubber | |
| Bearing of the shaft support | | | Desmopan® with rotating element in chromium-plated brass | | | |
| Foot | ABS | | Mechanical cast iron EN GJL-250 | | | |
| Mechanical Seal | Graphite and Alumina | | | | | |
| Elastomers | NBR rubber | | | | | |
| Cable | PVC ACS AD8 (for permanent immersion in drinking water) | | PVC | | | |

Electric submersible pumps SR

for tanks and reservoirs



PERFORMANCE DATA - 24 V DC

| Radial Impeller  | P2 | | 24 V DC | | | DNM | Q | Flow | | | | | | | | | |
|---|-------|------|---------|--|--|-----|-------|-------------------|----|------|-----|-----|-----|-----|----|-----|-----|
| | hp | kW | A | | | | | m ³ /h | 0 | 0,36 | 0,6 | 1,2 | 1,8 | 2,4 | 3 | 3,6 | 4,2 |
| | l/min | | | | | | | | | | | | | | | | |
| SERIES 80 | | | | | | | | | | | | | | | | | |
| SR 4/80 | 0,75 | 0,55 | 28 | | | 1"¼ | H (m) | 40 | 38 | 37 | 34 | 30 | 26 | 21 | 17 | 11 | 7 |

PERFORMANCE DATA - 2 poles 50 Hz

| Radial Impeller  | P2 | | 1~230 V | | 3~400 V | | DNM | Q | Flow | | | | | | | | | | | |
|---|-------|------|---------|------|---------|-------------------|-------|----|------|-----|-----|----|-----|-----|-----|-----|----|-----|-----|-----|
| | hp | kW | A | µF | A | m ³ /h | | | 0 | 1,2 | 2,4 | 3 | 3,6 | 4,2 | 4,8 | 5,4 | 6 | 6,6 | 7,2 | 7,8 |
| | l/min | | | | | | | | | | | | | | | | | | | |
| SERIES 100 | | | | | | | | | | | | | | | | | | | | |
| SR 3/100 | 0,7 | 0,5 | 4,2 | 16 | | 1"¼ | H (m) | 35 | 33 | 30 | 28 | 25 | 22 | 18 | 14 | 9 | | | | |
| SR 4/100 | 0,9 | 0,65 | 5 | 16 | 2 | 1"¼ | | 46 | 44 | 39 | 36 | 32 | 28 | 23 | 18 | 11 | | | | |
| SR 5/100 | 1,1 | 0,8 | 6,6 | 20 | 2,5 | 1"¼ | | 58 | 55 | 49 | 46 | 40 | 36 | 29 | 23 | 15 | | | | |
| SR 6/100 | 1,3 | 0,95 | 7,3 | 25 | 2,9 | 1"¼ | | 69 | 64 | 58 | 54 | 49 | 42 | 35 | 26 | 17 | | | | |
| SR 7/100 | 1,6 | 1,2 | 8,7 | 31,5 | 3,2 | 1"¼ | | 80 | 75 | 68 | 62 | 56 | 48 | 40 | 30 | 20 | | | | |
| SERIES 140 | | | | | | | | | | | | | | | | | | | | |
| SR 4/140 | 1 | 0,75 | 5,7 | 16 | 2,2 | 1"¼ | H (m) | 41 | 38 | 35 | 33 | 31 | 29 | 26 | 23 | 20 | 17 | 14 | 10 | 6 |
| SR 5/140 | 1,3 | 0,95 | 7,4 | 20 | 2,8 | 1"¼ | | 51 | 48 | 44 | 41 | 38 | 35 | 32 | 29 | 25 | 21 | 17 | 13 | 8 |
| SR 6/140 | 1,6 | 1,2 | 8,3 | 25 | 3,2 | 1"¼ | | 62 | 57 | 52 | 49 | 46 | 42 | 38 | 34 | 30 | 25 | 20 | 15 | 10 |

PERFORMANCE DATA - 2 poles 50 Hz

| Radial Impeller  | P2 | | 1~230 V | | 3~400 V | | DNM | Q | | Flow | | | | | | | | | | | |
|---|-----|-----|---------|-------|----------|------|----------|-------|------|------|------|-----|------|------|------|------|------|-----|------|-----|-----|
| | hp | kW | A | µF | A | m³/h | | 0 | 1,2 | 3,6 | 6 | 8,4 | 11,4 | 13,2 | 14,4 | 15,6 | 16,8 | 18 | 19,2 | 24 | 27 |
| | | | | | | | | l/min | 0 | 20 | 60 | 100 | 140 | 190 | 220 | 240 | 260 | 280 | 300 | 320 | 400 |
| SERIES 200 | | | | | | | | | | | | | | | | | | | | | |
| SR 3/200 | 1,5 | 1,1 | 8 | 40 | 3 | 2" | H (m) | 51 | 49 | 43 | 35 | 26 | 11 | 0,5 | | | | | | | |
| SR 4/200 | 2 | 1,5 | 10 | 45 | 3,5 | 2" | | 68 | 65 | 57 | 47 | 35 | 15 | 1 | | | | | | | |
| SR 5/200 | 3 | 2,2 | | | 5 | 2" | | 86 | 81 | 71 | 59 | 43 | 19 | 1,5 | | | | | | | |
| SERIES 230 | | | | | | | | | | | | | | | | | | | | | |
| SR 11/230 | 4 | 3 | | | 8 | 2" | H (m) | 103 | | | 91 | 79 | 55 | 39 | | | | | | | |
| SR 13/230 | 5,5 | 4 | | | 10 | 2" | | 125 | | | 111 | 94 | 66 | 44 | | | | | | | |
| SERIES 300 | | | | | | | | | | | | | | | | | | | | | |
| SR 2/300 | 1,5 | 1,1 | 8 | 40 | 3 | 2" | H (m) | 36 | | 33 | 30 | 26 | 19 | 16 | 13 | 10 | 7 | 4 | 1 | | |
| SR 3/300 | 2 | 1,5 | 10 | 45 | 3,5 | 2" | | 53 | | 49 | 44 | 38 | 28,5 | 24 | 20 | 15 | 11 | 6,5 | 1,5 | | |
| SR 4/300 | 3 | 2,2 | | | 5 | 2" | | 71 | | 64 | 58 | 51 | 38 | 32 | 26 | 20 | 15 | 8,5 | 2 | | |
| SR 5/300 | 4 | 3 | | | 7 | 2" | | 89 | | 81 | 74 | 64 | 48 | 40 | 33 | 25 | 18 | 11 | 2,5 | | |
| SERIES 330 | | | | | | | | | | | | | | | | | | | | | |
| SR 9/330 | 5,5 | 4 | | | 10 | 2" | H (m) | 89 | | | | | 67 | 58 | 53 | 47 | 41 | 34 | 27 | | |
| SERIES 400 | | | | | | | | | | | | | | | | | | | | | |
| SR 4/400 | 4 | 3 | | | 8 | 2" | H (m) | 50 | | | | | 41 | 39 | 36 | 35 | 32 | 31 | 29 | 20 | 14 |
| SR 5/400 | 5,5 | 4 | | | 10 | 2" | | 64 | | | | | 52 | 50 | 48 | 46 | 43 | 42 | 39 | 29 | 20 |
| SERIES 700 | | | | | | | | | | | | | | | | | | | | | |
| Semi-axial impeller  | P2 | | 3~400 V | | | DNM | Q | | Flow | | | | | | | | | | | | |
| hp | kW | A | m³/h | 0 | 1,2 | | 3,6 | 6 | 8,4 | 13,2 | 15,6 | 18 | 19,2 | 24 | 27 | 33 | 36 | 42 | | | |
| | | | | l/min | 0 | | 20 | 60 | 100 | 140 | 220 | 260 | 300 | 320 | 400 | 450 | 550 | 600 | 700 | | |
| SERIES 700 | | | | | | | | | | | | | | | | | | | | | |
| SR 3/700 | 5,5 | 4 | 10 | 2" | H (m) | 41 | | | | | | | 35 | 34,5 | 31 | 28 | 22 | 18 | 9 | | |

Electric submersible pumps SR series 80

for tanks and reservoirs

PERFORMANCE DATA - 24 V DC

| Radial Impeller  | Code | Version | | P2 | | P1 | A | Flow | | DNM | Dimensions (mm) | | | Weight |
|---|-----------|---------|----|------|------|------|----|-------------|-------------|-----|-----------------|-----|-----|--------|
| | | | | hp | kW | kW | | l/min | m | | A | B | C | |
| | | | | | | | | | | | | | | |
| SR 4/80 | RF80/04/1 | 24 V | DC | 0,75 | 0,55 | 0,67 | 28 | 6 - 30 - 80 | 38 - 30 - 7 | 1"¼ | 500 | 100 | 130 | 10,2 |



P1: Max. absorbed power - P2: Nominal power of the motor

SUPPLIED WITH

5 meters power cable



ACCESSORIES

| Code | Description | |
|----------|--|--|
| 03710036 | Suction adaptor baseplate |  |
| 02076100 | DC electromechanical, direct starter QDC |  |

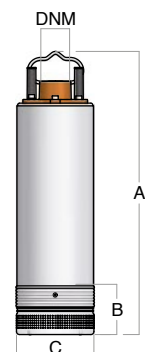

PERFORMANCE CURVES - 24 V DC

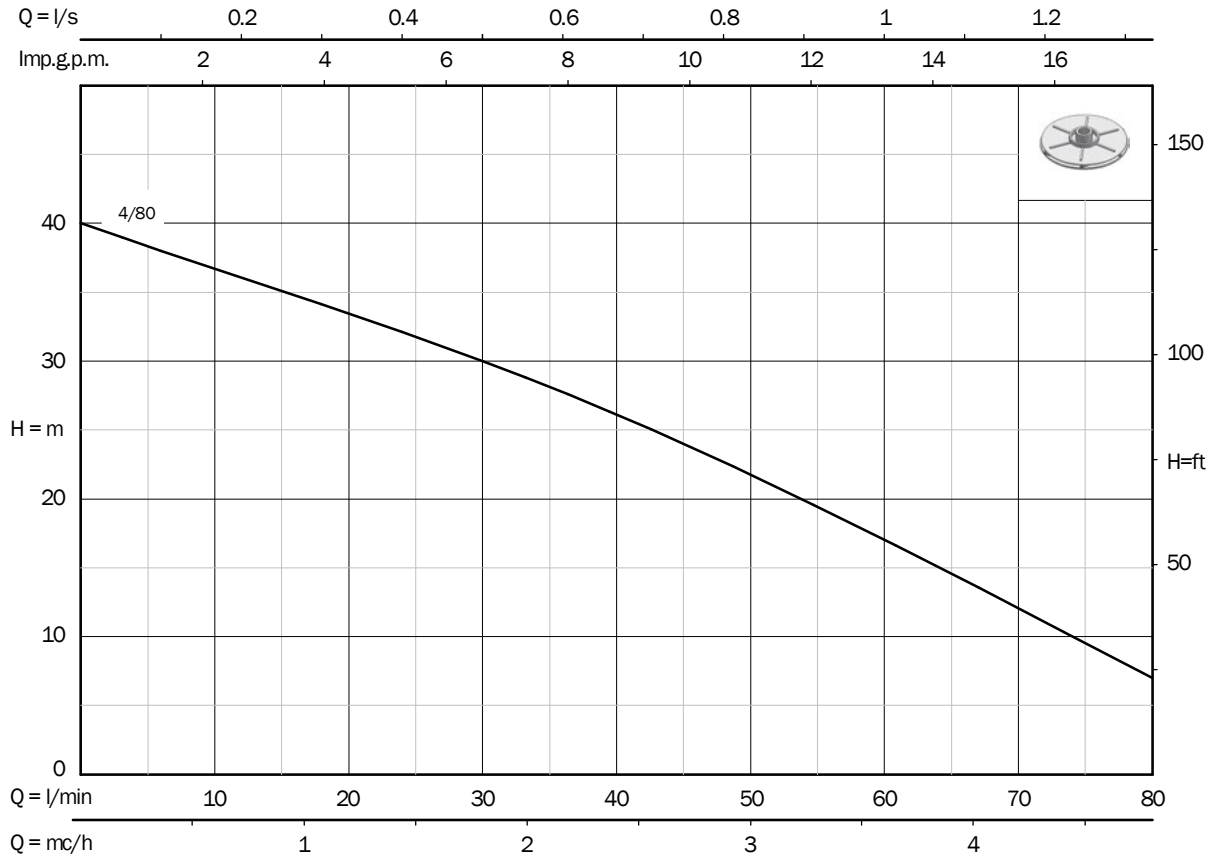
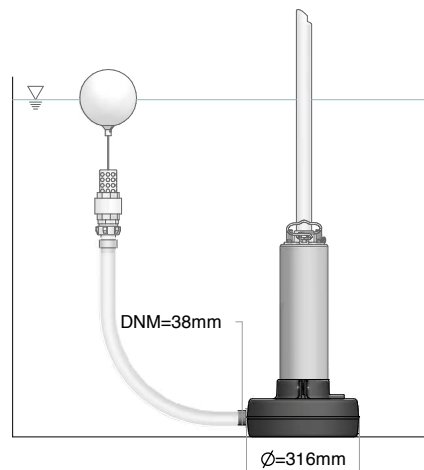



Illustration of how a suction adaptor baseplate can be installed



Electric submersible pumps SR series 100

for tanks and reservoirs

PERFORMANCE DATA - 2 poles 50 Hz

| Radial Impeller  | Code | Version | | P2 | | A | Flow | | DNM | Dimensions (mm) | | | Weight kg |
|---|--------------|---------|---------------|-----|------|-----|---------------|--------------|-----|-----------------|-----|-----|--------------|
| | | | | hp | kW | | l/min | m | | A | B | C | |
| | | | | | | | | | | | | | |
| SR 3/100 | RM100/03/2 | 230 V | 1-phase | 0,7 | 0,5 | 4,2 | 20 - 50 - 100 | 33 - 28 - 9 | 1"¼ | 437 | 100 | 130 | 11,3 |
| | RM100/03+G/2 | 230 V | 1-phase+float | | | | | | | | | | 11,5 |
| SR 4/100 | RM100/04/2 | 230 V | 1-phase | 0,9 | 0,65 | 5 | 20 - 50 - 100 | 44 - 36 - 11 | 1"¼ | 461 | 100 | 130 | 11,5 |
| | RM100/04+G/2 | 230 V | 1-phase+float | | | | | | | | | | 11,7 |
| | RT100/04/1 | 400 V | 3-phase | | | | | | | | | | 2 |
| SR 5/100 | RM100/05/2 | 230 V | 1-phase | 1,1 | 0,8 | 6,6 | 20 - 50 - 100 | 55 - 46 - 15 | 1"¼ | 500 | 100 | 130 | 12,8 |
| | RM100/05+G/2 | 230 V | 1-phase+float | | | | | | | | | | 13 |
| | RT100/05/1 | 400 V | 3-phase | | | | | | | | | | 2,5 |
| SR 6/100 | RM100/06/2 | 230 V | 1-phase | 1,3 | 0,95 | 7,3 | 20 - 50 - 100 | 64 - 54 - 17 | 1"¼ | 544 | 100 | 130 | 14,5 |
| | RM100/06+G/2 | 230 V | 1-phase+float | | | | | | | | | | 14,7 |
| | RT100/06/1 | 400 V | 3-phase | | | | | | | | | | 2,9 |
| SR 7/100 | RM100/07/2 | 230 V | 1-phase | 1,6 | 1,2 | 8,7 | 20 - 50 - 100 | 75 - 62 - 20 | 1"¼ | 588 | 100 | 130 | 16,5 |
| | RM100/07+G/2 | 230 V | 1-phase+float | | | | | | | | | | 16,7 |
| | RT100/07/1 | 400 V | 3-phase | | | | | | | | | | 3,2 |

SUPPLIED WITH

10 meters power cable



Capacitor (single-phase version)



Built-in thermal protection with manual reset
(single-phase versions)



OPTIONS

20 meters power cable



30 meters power cable



PERFORMANCE CURVES - 2 poles 50 Hz

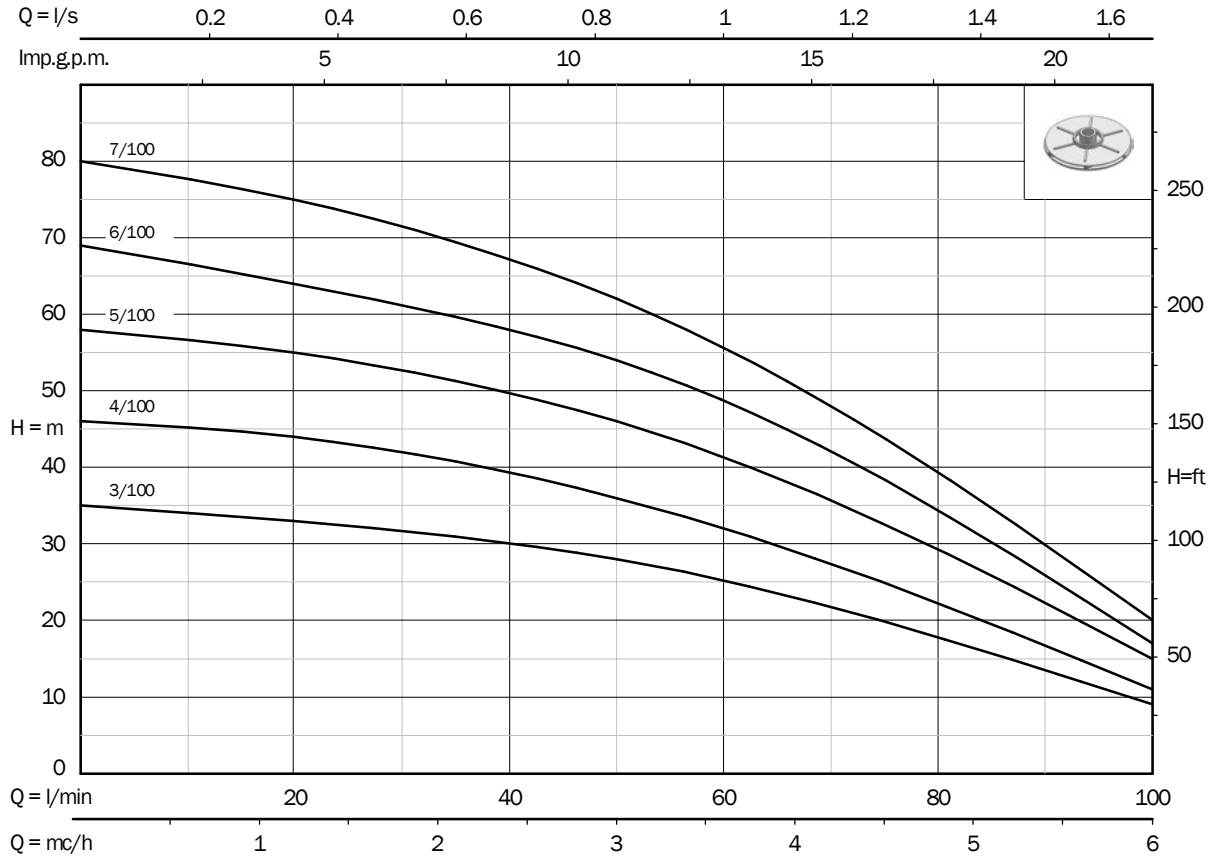

ACCESSORIES



| Code | Description | |
|----------|--|---|
| 03710036 | Suction adaptor baseplate |  |
| 020700.. | Single-phase direct starter QM IT with bipolar, illuminated thermal protector switch with facility to wire the capacitor |  |
| 020811.. | Three-phase electromechanical direct starter QT MT |  |

Illustration of how a suction adaptor baseplate can be installed



Electric submersible pumps SR series 140

for tanks and reservoirs

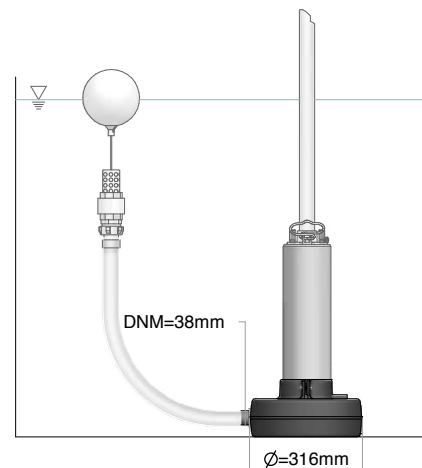
PERFORMANCE DATA - 2 poles 50 Hz

| Radial Impeller  | Code | Version | | P2 | | A | Flow | | DNM | Dimensions (mm) | | | Weight kg |
|---|--------------|---------|---------------|-----|------|-----|---------------|--------------|-----|-----------------|-----|-----|--------------|
| | | | | hp | kW | | l/min | m | | A | B | C | |
| SR 4/140 | RM140/04/2 | 230 V | 1-phase | 1 | 0,75 | 5,7 | 20 - 90 - 140 | 38 - 23 - 6 | 1"¼ | 461 | 100 | 130 | 11,6 |
| | RM140/04+G/2 | 230 V | 1-phase+float | | | | | | | | | | 11,8 |
| | RT140/04/1 | 400 V | 3-phase | | | | | | | | | | 2,2 |
| SR 5/140 | RM140/05/2 | 230 V | 1-phase | 1,3 | 0,95 | 7,4 | 20 - 90 - 140 | 48 - 29 - 8 | 1"¼ | 500 | 100 | 130 | 13,2 |
| | RM140/05+G/2 | 230 V | 1-phase+float | | | | | | | | | | 13,4 |
| | RT140/05/1 | 400 V | 3-phase | | | | | | | | | | 2,8 |
| SR 6/140 | RM140/06/2 | 230 V | 1-phase | 1,6 | 1,2 | 8,3 | 20 - 90 - 140 | 57 - 34 - 10 | 1"¼ | 544 | 100 | 130 | 14,6 |
| | RM140/06+G/2 | 230 V | 1-phase+float | | | | | | | | | | 14,8 |
| | RT140/06/1 | 400 V | 3-phase | | | | | | | | | | 3,2 |

SUPPLIED WITH

10 meters power cable



Capacitor (single-phase version)



Built-in thermal protection with manual reset (single-phase versions)



OPTIONS

20 meters power cable



30 meters power cable



PERFORMANCE CURVES - 2 poles 50 Hz

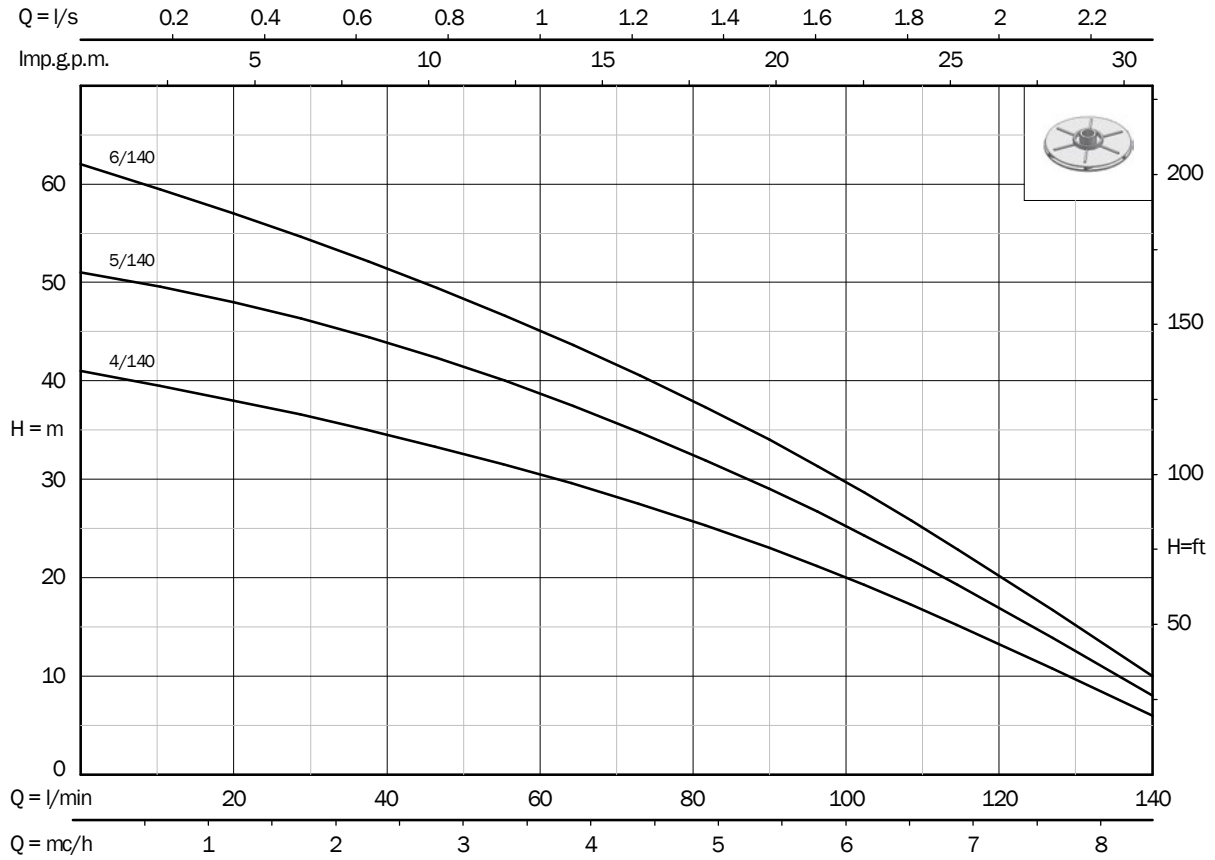

ACCESSORIES



| Code | Description | |
|----------|--|---|
| 03710036 | Suction adaptor baseplate |  |
| 020700.. | Single-phase direct starter QM IT with bipolar, illuminated thermal protector switch with facility to wire the capacitor |  |
| 020811.. | Three-phase electromechanical direct starter QT MT |  |

Illustration of how a suction adaptor baseplate can be installed



Electric submersible pumps SR series 200

for tanks and reservoirs

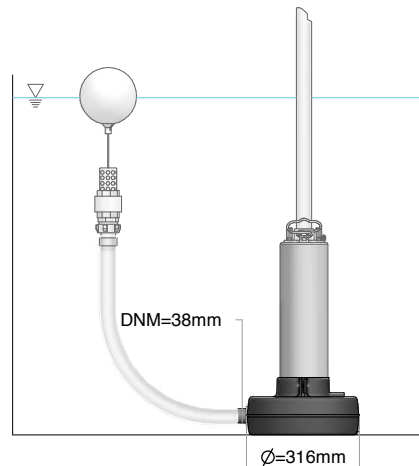
PERFORMANCE DATA - 2 poles 50 Hz

| Radial Impeller  | Code | Version | | P2 | | A | Flow | | DNM | Dimensions (mm) | | | Weight kg |
|---|----------|---------|---------|-----|-----|-----|----------------|---------------|-----|-----------------|-----|-----|--------------|
| | | | | hp | kW | | l/min | m | | A | B | C | |
| SR 3/200 | RM200/03 | 230 V | 1-phase | 1,5 | 1,1 | 8 | 20 - 140 - 220 | 49 - 26 - 0,5 | 2" | 639 | 150 | 145 | 21,2 |
| | RT200/03 | 400 V | 3-phase | | | 3 | | | | | | | 20,4 |
| SR 4/200 | RM200/04 | 230 V | 1-phase | 2 | 1,5 | 10 | 20 - 140 - 220 | 65 - 35 - 1 | 2" | 700 | 150 | 145 | 24 |
| | RT200/04 | 400 V | 3-phase | | | 3,5 | | | | 675 | | | 20,8 |
| SR 5/200 | RT200/05 | 400 V | 3-phase | 3 | 2,2 | 5 | 20 - 140 - 220 | 81 - 43 - 1,5 | 2" | 736 | 150 | 145 | 23,7 |



SUPPLIED WITH



10 meters power cable



Capacitor (single-phase versions)



ACCESSORIES

| Code | Description | |
|----------|--|--|
| 020700.. | Single-phase direct starter QM IT with bipolar, illuminated thermal protector switch with facility to wire the capacitor |  |
| 020811.. | Three-phase electromechanical direct starter QT MT |  |

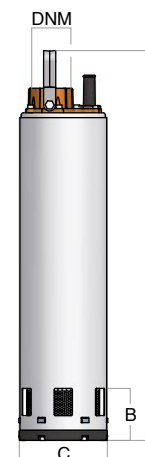

PERFORMANCE CURVES - 2 poles 50 Hz

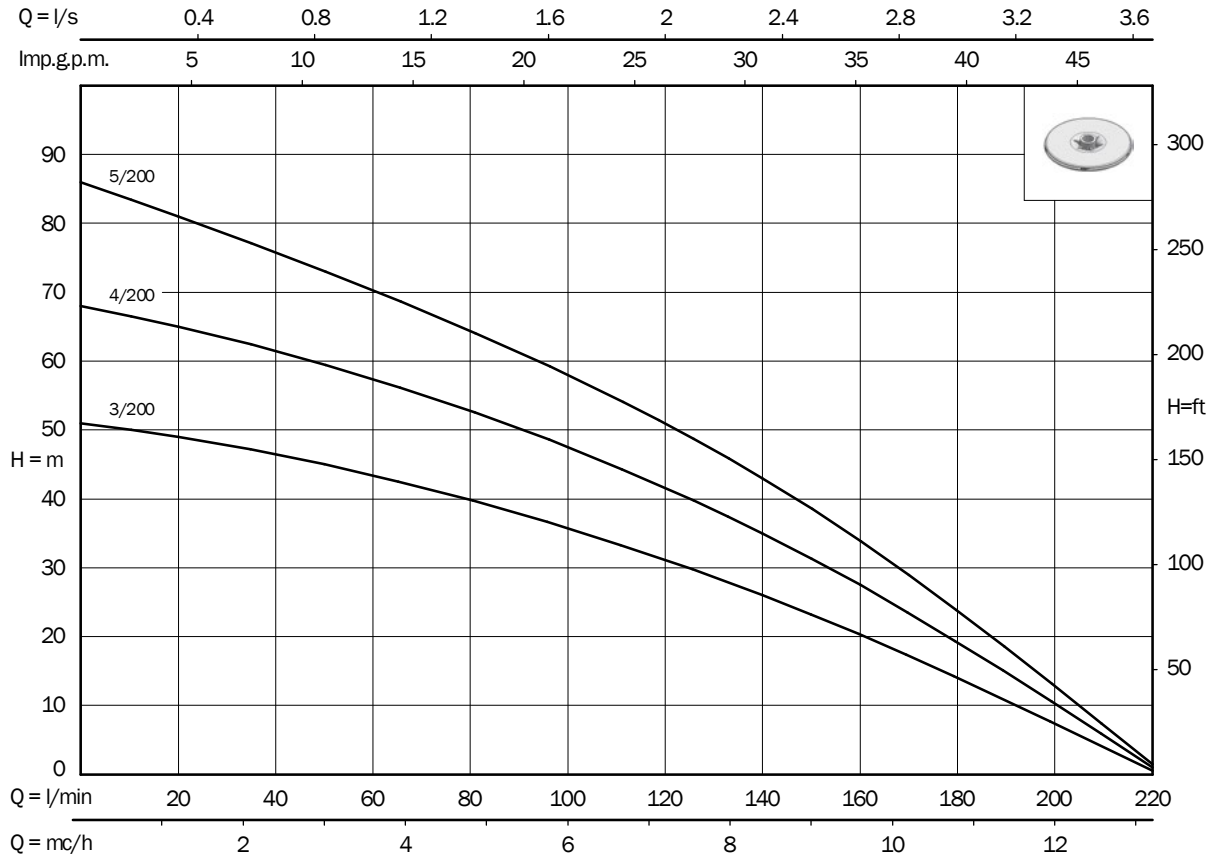

Electric submersible pumps SR series 230

for tanks and reservoirs

PERFORMANCE DATA - 2 poles 50 Hz

| Radial Impeller  | Code | Version | | P2 | | A | Flow | | DNM | Dimensions (mm) | | | Weight kg |
|---|----------|---------|---------|-----|----|----|-----------------|---------------|-----|-----------------|-----|-----|--------------|
| | | | | hp | kW | | l/min | m | | A | B | C | |
| SR 11/230 | RT230/11 | 400 V | 3-phase | 4 | 3 | 8 | 100 - 180 - 220 | 91 - 61 - 39 | 2" | 1375 | 100 | 142 | 37 |
| SR 13/230 | RT230/13 | 400 V | 3-phase | 5,5 | 4 | 10 | 100 - 180 - 220 | 111 - 72 - 44 | 2" | 1496 | 100 | 142 | 42,4 |





SUPPLIED WITH

3 meters power cable



ACCESSORIES

| Code | Description |
|----------|---|
| 02081140 | Three-phase Electromechanical direct starter QT MT 10 4 hp  |
| 02081030 | Three-phase Electromechanical direct starter AT 55 CL 5,5 hp  |

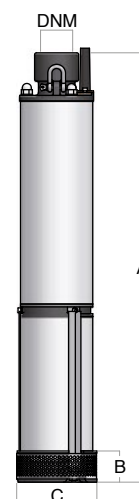

PERFORMANCE CURVES - 2 poles 50 Hz

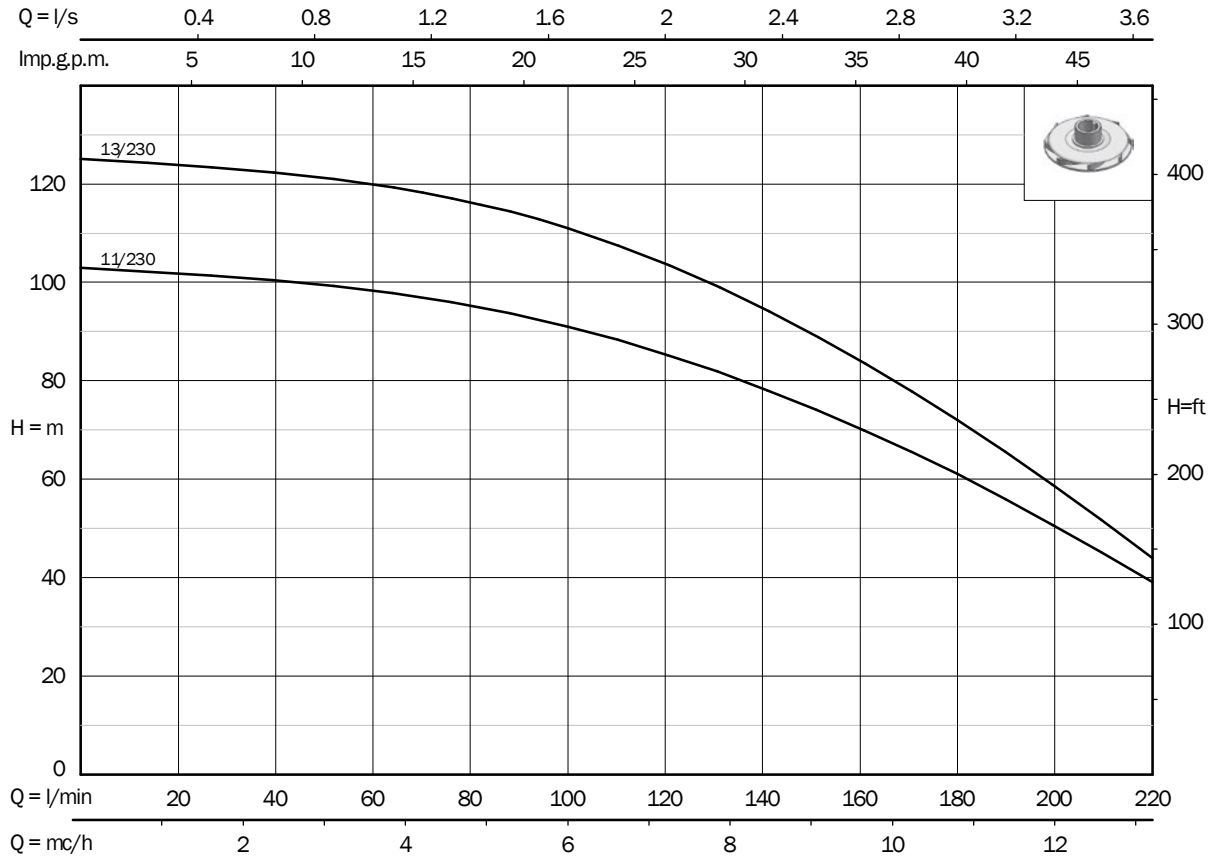

Electric submersible pumps SR series 300

for tanks and reservoirs

PERFORMANCE DATA - 2 poles 50 Hz

| Radial Impeller  | Code | Version | | P2 | | A | Flow | | DNM | Dimensions (mm) | | | Weight kg |
|---|----------|---------|---------|-----|-----|-----|----------------|---------------|-----|-----------------|-----|-----|--------------|
| | | | | hp | kW | | l/min | m | | A | B | C | |
| SR 2/300 | RM300/02 | 230 V | 1-phase | 1,5 | 1,1 | 8 | 60 - 220 - 320 | 33 - 16 - 1 | 2" | 603 | 150 | 145 | 20 |
| | RT300/02 | 400 V | 3-phase | | | 3 | | | | | | | 19,8 |
| SR 3/300 | RM300/03 | 230 V | 1-phase | 2 | 1,5 | 10 | 60 - 220 - 320 | 49 - 24 - 1,5 | 2" | 664 | 150 | 145 | 23,3 |
| | RT300/03 | 400 V | 3-phase | | | 3,5 | | | | | | | 20,3 |
| SR 4/300 | RT300/04 | 400 V | 3-phase | 3 | 2,2 | 5 | 60 - 220 - 320 | 64 - 32 - 2 | 2" | 700 | 150 | 145 | 23,5 |
| SR 5/300 | RT300/05 | 400 V | 3-phase | 4 | 3 | 7 | 60 - 220 - 320 | 81 - 40 - 2,5 | 2" | 776 | 150 | 145 | 27 |

SUPPLIED WITH



10 meters power cable



Capacitor (single-phase versions)



ACCESSORIES

| Code | Description | |
|----------|--|--|
| 020700.. | Single-phase direct starter QM IT with bipolar, illuminated thermal protector switch with facility to wire the capacitor |  |
| 020811.. | Three-phase electromechanical direct starter QT MT |  |

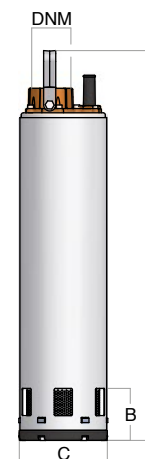

PERFORMANCE CURVES - 2 poles 50 Hz

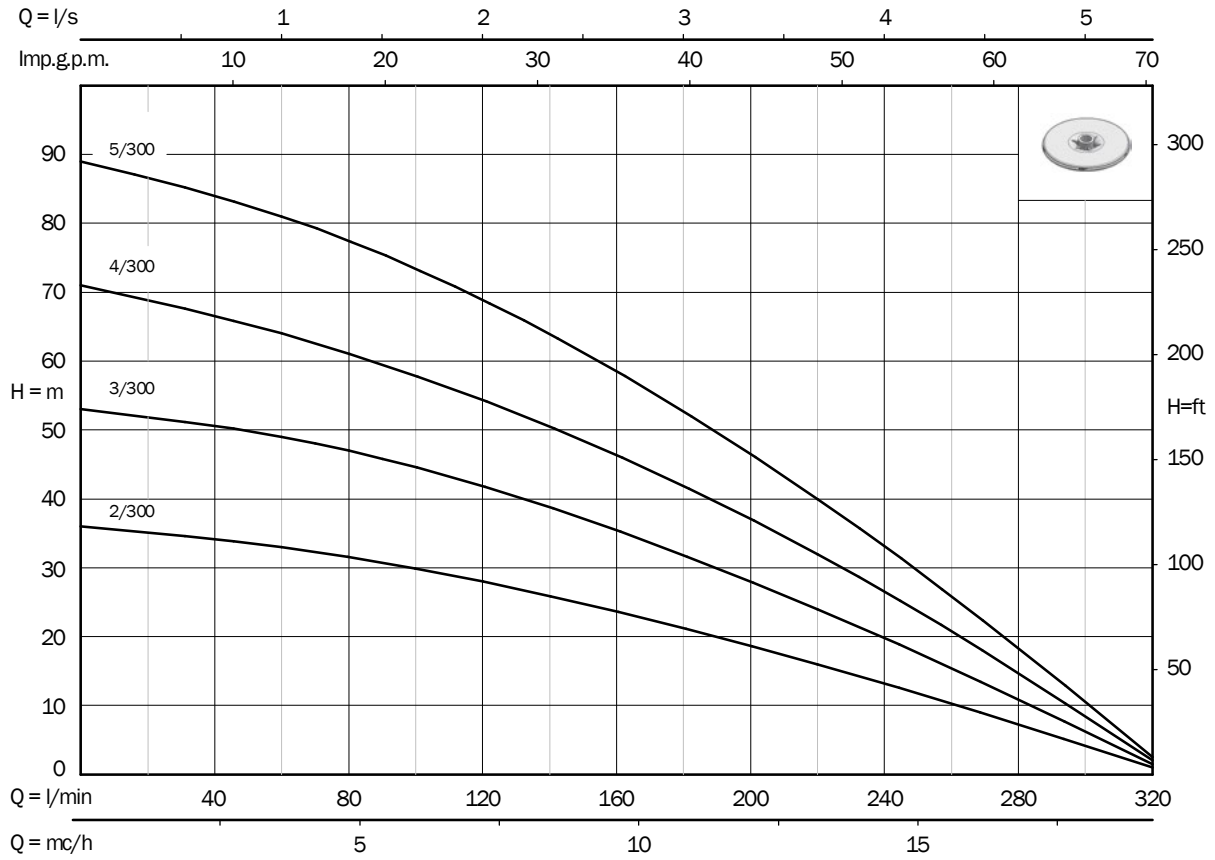

Electric submersible pumps SR series 330

for tanks and reservoirs

PERFORMANCE DATA - 2 poles 50 Hz

| Radial Impeller  | Code | Version | | P2 | | A | Flow | | DNM | Dimensions (mm) | | | Weight kg |
|---|----------|---------|---------|-----|----|----|-----------------|--------------|-----|-----------------|-----|-----|--------------|
| | | | | hp | kW | | l/min | m | | A | B | C | |
| SR 9/330 | RT330/09 | 400 V | 3-phase | 5,5 | 4 | 10 | 180 - 260 - 320 | 68 - 47 - 27 | 2" | 1352 | 100 | 142 | 39,4 |



SUPPLIED WITH

3 meters power cable



ACCESSORIES

| Code | Description |
|----------|--|
| 02081030 | Three-phase Electromechanical direct starter AT 55 CL 5,5 hp |

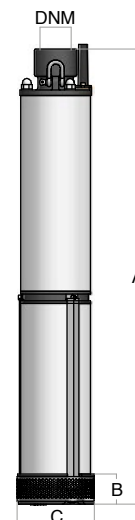

PERFORMANCE CURVES - 2 poles 50 Hz

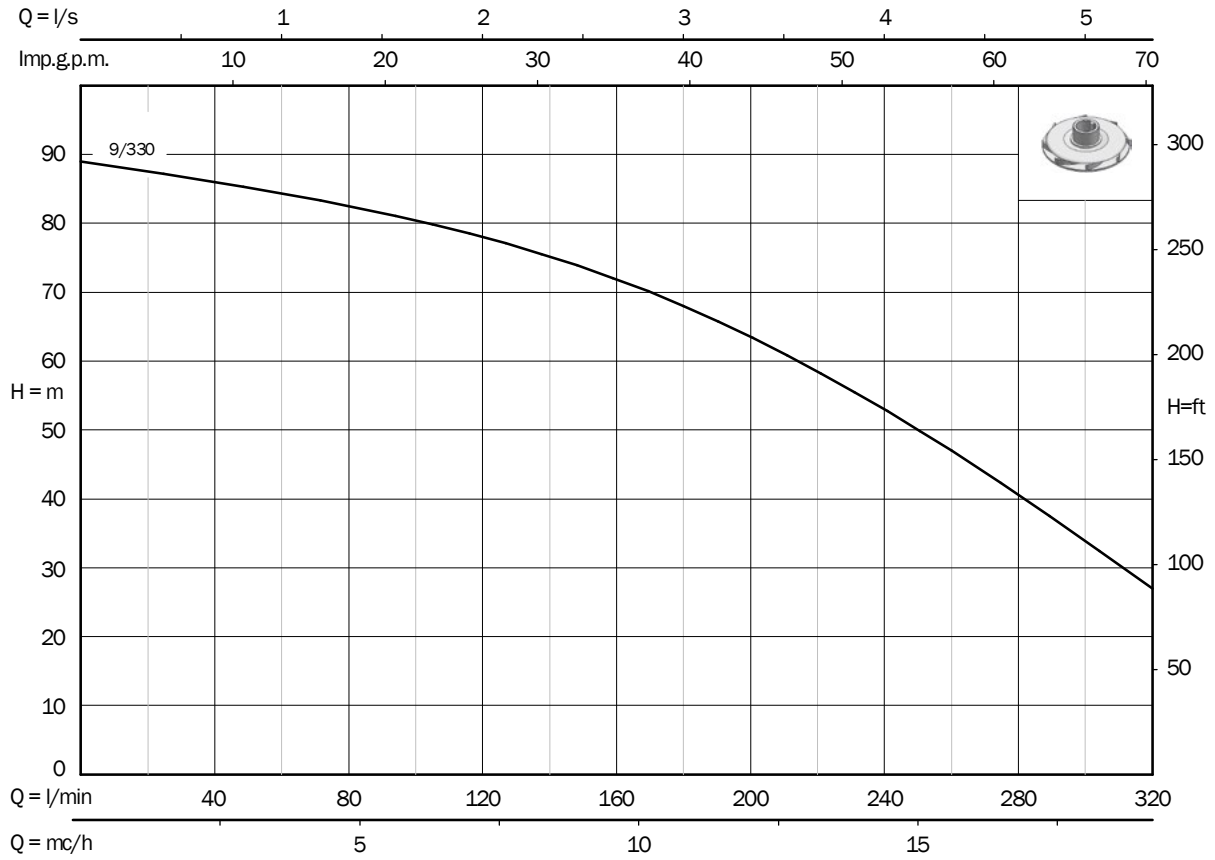

Electric submersible pumps SR series 400

for tanks and reservoirs

PERFORMANCE DATA - 2 poles 50 Hz

| Radial Impeller  | Code | Version | | P2 | | A | Flow | | DNM | Dimensions (mm) | | | Weight kg |
|---|----------|---------|---------|-----|----|----|-----------------|--------------|-----|-----------------|-----|-----|--------------|
| | | | | hp | kW | | l/min | m | | A | B | C | |
| SR 4/400 | RT400/04 | 400 V | 3-phase | 4 | 3 | 8 | 190 - 300 - 450 | 41 - 31 - 14 | 2" | 1185 | 100 | 142 | 39,5 |
| SR 5/400 | RT400/05 | 400 V | 3-phase | 5,5 | 4 | 10 | 190 - 300 - 450 | 52 - 42 - 20 | 2" | 1284 | 100 | 142 | 44,4 |





SUPPLIED WITH

3 meters power cable



ACCESSORIES

| Code | Description |
|----------|---|
| 02081140 | Three-phase Electromechanical direct starter QT MT 10 4 hp  |
| 02081030 | Three-phase Electromechanical direct starter AT 55 CL 5,5 hp  |

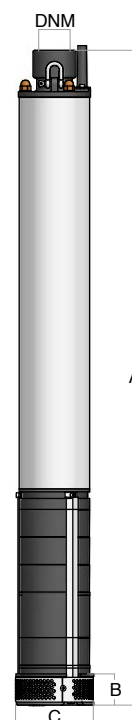

PERFORMANCE CURVES - 2 poles 50 Hz

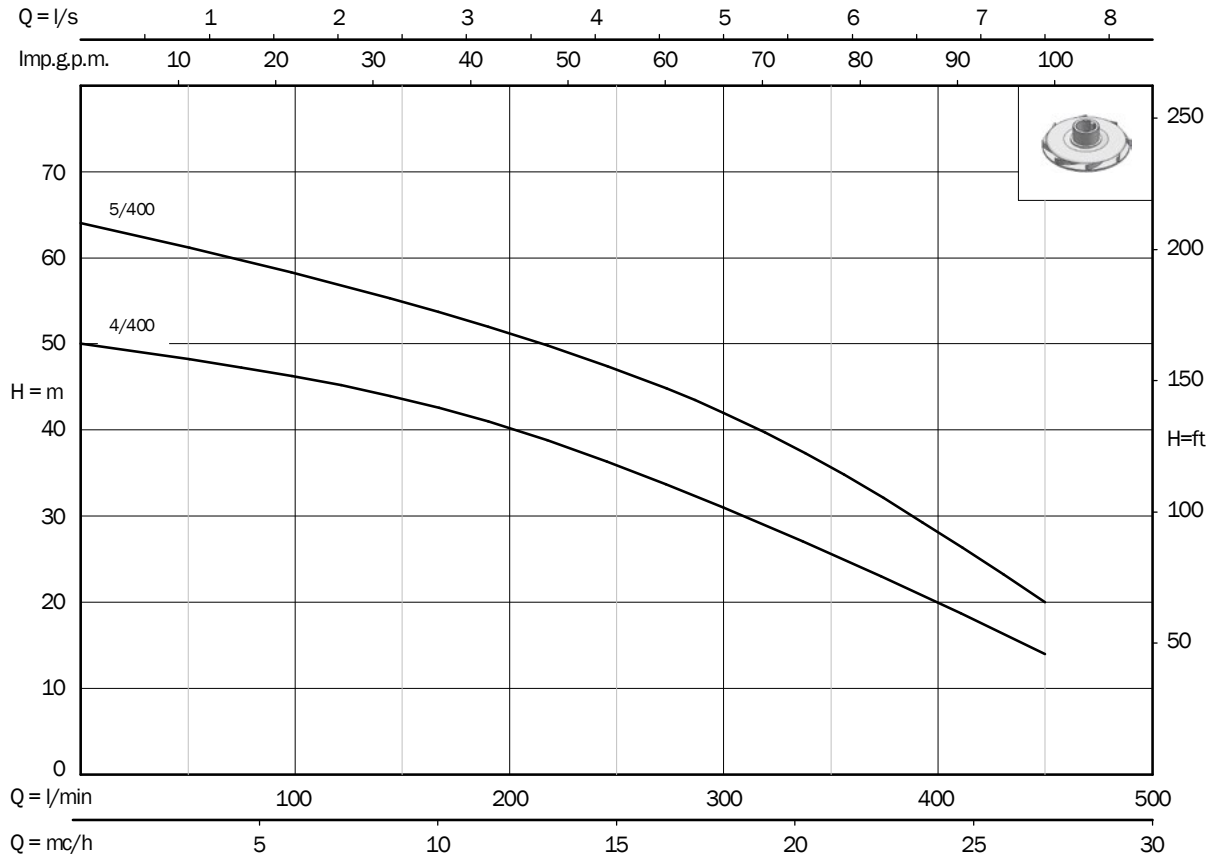

Electric submersible pumps SR series 700

for tanks and reservoirs

PERFORMANCE DATA - 2 poles 50 Hz

| Semi-axial impeller  | Code | Version | | P2 | | A | Flow | | DNM | Dimensions (mm) | | | Weight kg |
|---|----------|---------|---------|-----|----|----|-----------------|-------------|-----|-----------------|-----|-----|--------------|
| | | | | hp | kW | | l/min | m | | A | B | C | |
| SR 3/700 | RT700/03 | 400 V | 3-phase | 5,5 | 4 | 10 | 300 - 500 - 700 | 35 - 25 - 9 | 2" | 1262 | 120 | 142 | 38,9 |

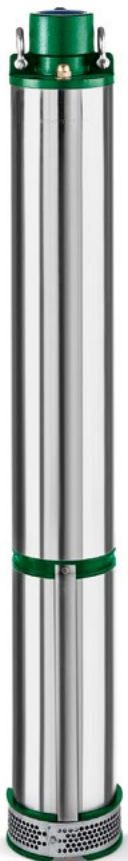

SUPPLIED WITH

3 meters power cable



ACCESSORIES

| Code | Description |
|----------|--|
| 02081030 | Three-phase Electromechanical direct starter AT 55 CL 5,5 hp |

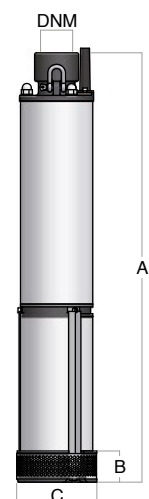

PERFORMANCE CURVES - 2 poles 50 Hz

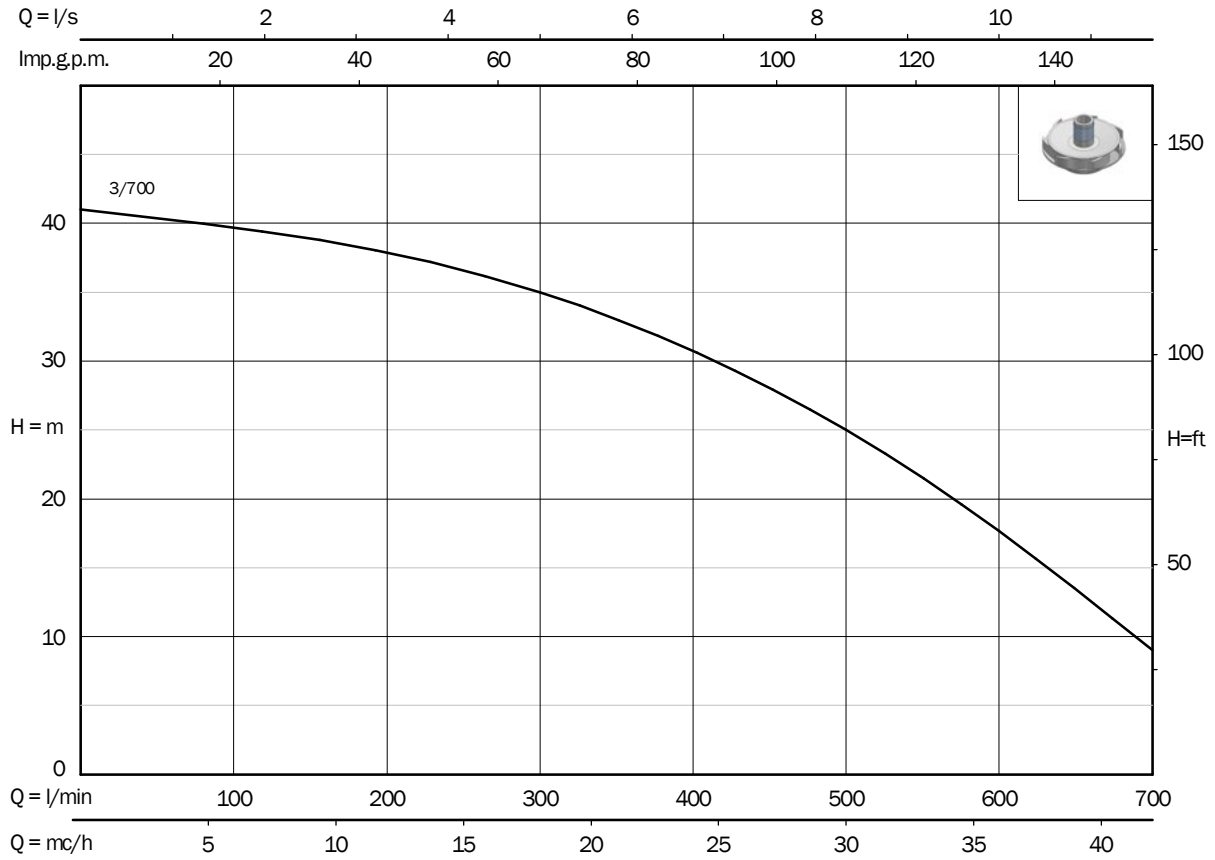

IDROSOM 4"

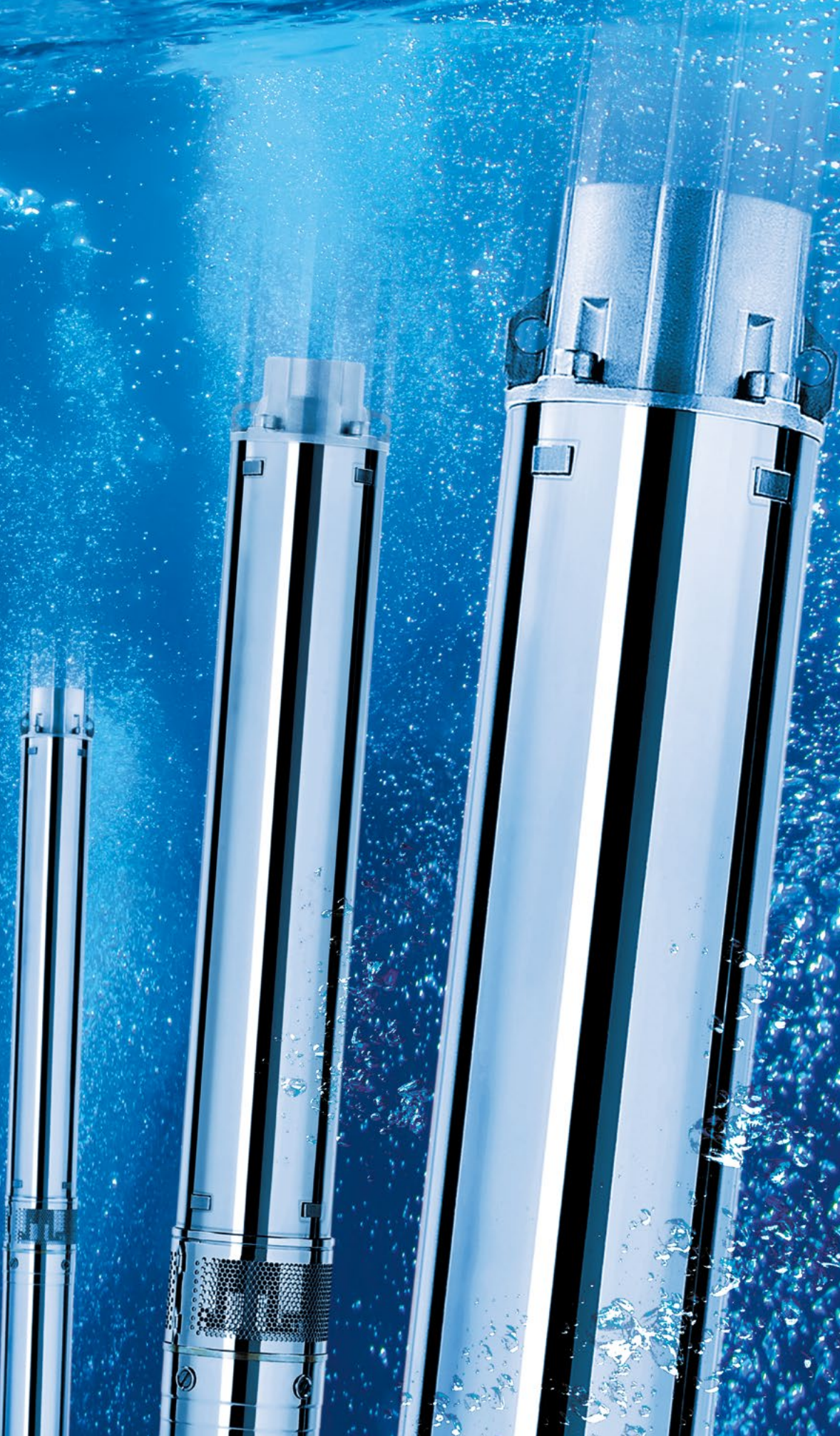

Electric submersible pumps IDROSOM

for 4" boreholes



APPLICATION

To pump water from boreholes

To pressurize civil, agricultural, industrial and fire-fighting plants

Irrigation

CONSTRUCTION

Eco-friendly design for water pumps. The submersible pumps Idrosom /60 and /100 successfully comply with the parameters of efficiency approved by the European commission on best technology available on the market (MEI Index $\geq 0,7$)

Coolant filled, asynchronous, rewindable electric AC motor with short circuit rotor. Insulation Class F

Resin-insulated cable kit to prevent penetration of water inside the motor ("S" series motors)

Shafts machined on ball bearings and mechanical seals location

Both shaft and coupling meet NEMA standards

APPLICATION RANGE

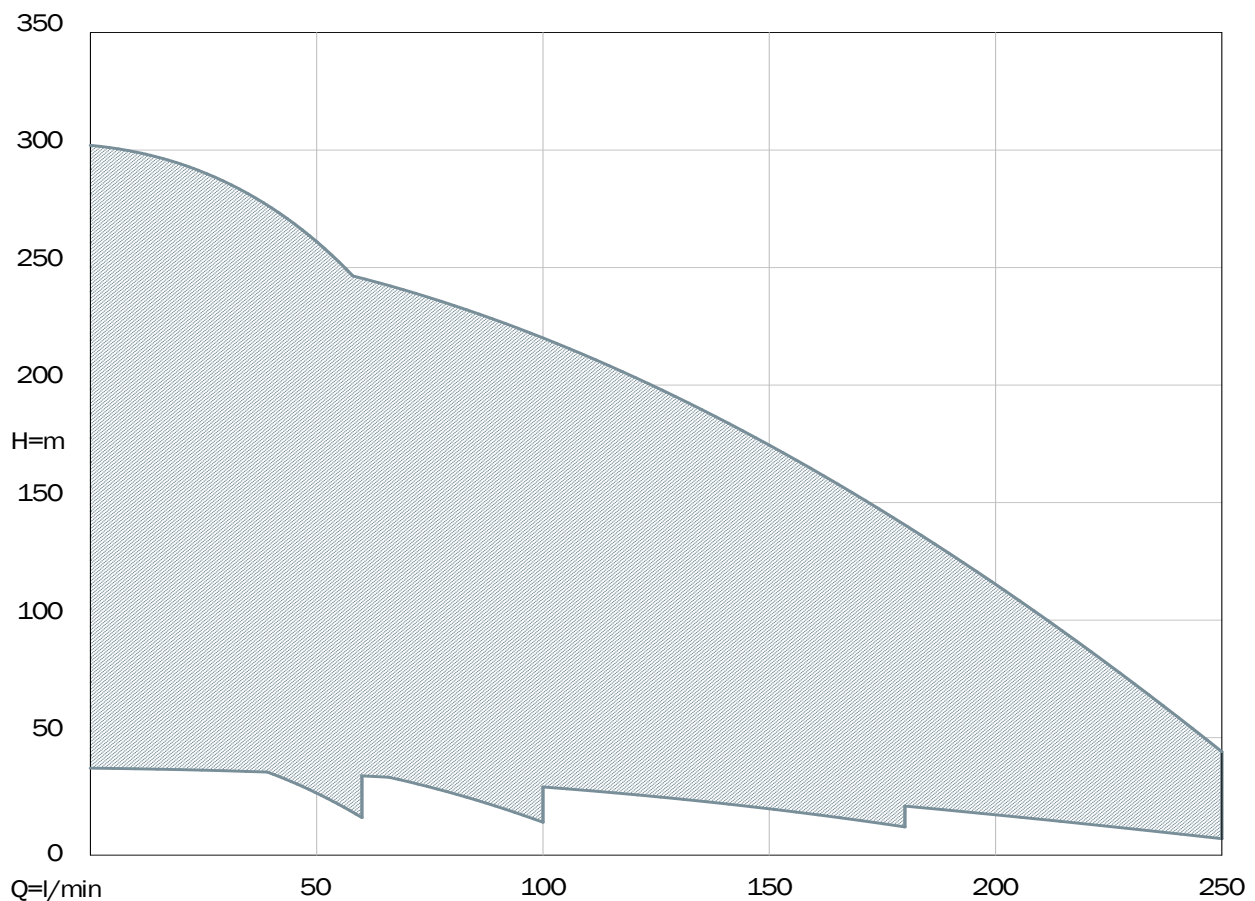

Electric submersible pumps IDROSOM

for 4" boreholes



ErP Directive

Eco-friendly design for water pumps. The submersible pumps Idrosom /60 and /100 successfully comply with the parameters of efficiency approved by the European commission on best technology available on the market (MEI Index $\geq 0,7$).



APPLICATION FEATURES - PUMP END

| | IDROSOM | | | |
|--|---------|--------|--------|--------|
| | /60 | /100 | /180 | /250 |
| Minimum depth of the liquid to be pumped (m) | 0,8 | | | |
| Maximum temperature of the water to be pumped (°C) | 60 | | | |
| PH of the liquid pumped | 6 - 10 | | | |
| Maximum sand content (g/m ³) | 150 | | | |
| Suitable to operate horizontally (included) | 23/60 | 18/100 | 17/180 | 12/250 |

MATERIALS - PUMP END

| | IDROSOM | | | |
|-------------------------|--|------|------|------|
| | /60 | /100 | /180 | /250 |
| Head and suction body | Stainless Steel AISI304 | | | |
| Casing, bolts and nuts | Stainless Steel AISI304 | | | |
| Shaft | Stainless Steel AISI304 | | | |
| Coupling | Stainless Steel AISI316 | | | |
| Impellers and diffusers | Noryl® reinforced with fibre-glass, certified for drinking water | | | |
| Top bearing | Rubber with rotating element in Stainless Steel AISI316 | | | |

APPLICATION FEATURES - MOTOR

| | MOTOR | |
|--|---------------------------|-------------|
| | 4" S series | 4" E series |
| IP rating | IP68 | |
| Duty | Continuous S1 | |
| Maximum immersion depth (m) | 150 | |
| Maximum number of starts per hour | 30 | |
| Maximum temperature of the water pumped (°C) | 35 | |
| PH of the liquid pumped | 6 - 10 | |
| Suitable for inverter drive | Three-phase versions only | |
| Suitable to operate horizontally (Included) | 5,5 hp | |



MATERIALS - MOTOR

| | MOTOR | |
|-----------------|-------------------------|--|
| | 4" S series | 4" E series |
| Casing | Stainless steel AISI304 | |
| Shaft terminal | Stainless steel AISI303 | Stainless steel AISI304 |
| Upper body | Brass OT58 | Nickel plated cast iron, with protection Stainless steel AISI304 |
| Elastomers | NBR Rubber | |
| Mechanical seal | Graphite and alumina | |
| Cable | PVC | ACS Cross-linked rubber |

Electric submersible pumps IDROSOM

for 4" boreholes

PERFORMANCE DATA - PUMP ENDS - 2 poles 50 Hz

| Radial impeller  | P2 | | DNM | Q | Flow | | | | | | | | | | | | | | | | |
|---|------|------|-----|-------|------|-----|-----|-----|-----|-----|-----|-----|-----|-----|-----|-----|------|-----|------|-----|----|
| | hp | kW | | m³/h | 0 | 0,6 | 1,2 | 1,8 | 2,4 | 3 | 3,6 | 4,5 | 6 | 7,2 | 8,4 | 9,6 | 10,8 | 12 | 13,5 | 15 | |
| | | | | l/min | 0 | 10 | 20 | 30 | 40 | 50 | 60 | 75 | 100 | 120 | 140 | 160 | 180 | 200 | 225 | 250 | |
| SERIES 60 | | | | | | | | | | | | | | | | | | | | | |
| IDROSOM 8/60 | 0,5 | 0,37 | 1"½ | H (m) | 49 | 48 | 45 | 41 | 35 | 27 | 16 | | | | | | | | | | |
| IDROSOM 12/60 | 0,75 | 0,55 | 1"½ | | 74 | 73 | 69 | 62 | 52 | 40 | 24 | | | | | | | | | | |
| IDROSOM 15/60 | 1 | 0,75 | 1"½ | | 92 | 90 | 85 | 78 | 66 | 50 | 30 | | | | | | | | | | |
| IDROSOM 23/60 | 1,5 | 1,1 | 1"½ | | 140 | 137 | 130 | 119 | 101 | 77 | 45 | | | | | | | | | | |
| IDROSOM 30/60 | 2 | 1,5 | 1"½ | | 184 | 179 | 169 | 155 | 132 | 100 | 59 | | | | | | | | | | |
| IDROSOM 43/60 | 3 | 2,2 | 1"½ | | 263 | 257 | 243 | 222 | 189 | 144 | 84 | | | | | | | | | | |
| SERIES 100 | | | | | | | | | | | | | | | | | | | | | |
| IDROSOM 7/100 | 0,75 | 0,55 | 1"½ | H (m) | 45 | | 44 | 43 | 41 | 39 | 36 | 29 | 14 | | | | | | | | |
| IDROSOM 9/100 | 1 | 0,75 | 1"½ | | 57 | | 55 | 54 | 53 | 50 | 46 | 38 | 18 | | | | | | | | |
| IDROSOM 14/100 | 1,5 | 1,1 | 1"½ | | 88 | | 86 | 85 | 82 | 78 | 72 | 60 | 28 | | | | | | | | |
| IDROSOM 18/100 | 2 | 1,5 | 1"½ | | 113 | | 110 | 107 | 104 | 99 | 91 | 76 | 36 | | | | | | | | |
| IDROSOM 27/100 | 3 | 2,2 | 1"½ | | 170 | | 167 | 163 | 156 | 148 | 137 | 112 | 53 | | | | | | | | |
| IDROSOM 36/100 | 4 | 3 | 1"½ | | 226 | | 220 | 215 | 208 | 197 | 182 | 151 | 71 | | | | | | | | |
| IDROSOM 48/100 | 5,5 | 4 | 1"½ | | 302 | | 295 | 288 | 277 | 261 | 242 | 200 | 96 | | | | | | | | |
| SERIES 180 | | | | | | | | | | | | | | | | | | | | | |
| IDROSOM 6/180 | 1 | 0,75 | 2" | H (m) | 37 | | | | | | | 32 | 29 | 26 | 22 | 17 | 12 | | | | |
| IDROSOM 9/180 | 1,5 | 1,1 | 2" | | 55 | | | | | | | | 48 | 44 | 38 | 32 | 26 | 18 | | | |
| IDROSOM 12/180 | 2 | 1,5 | 2" | | 74 | | | | | | | | 64 | 58 | 51 | 43 | 34 | 23 | | | |
| IDROSOM 17/180 | 3 | 2,2 | 2" | | 104 | | | | | | | | 91 | 82 | 72 | 61 | 48 | 33 | | | |
| IDROSOM 24/180 | 4 | 3 | 2" | | 147 | | | | | | | | 128 | 116 | 102 | 86 | 68 | 46 | | | |
| IDROSOM 31/180 | 5,5 | 4 | 2" | | 190 | | | | | | | | 165 | 149 | 131 | 111 | 87 | 59 | | | |
| IDROSOM 42/180 | 7,5 | 5,5 | 2" | | 257 | | | | | | | | 223 | 202 | 177 | 150 | 118 | 80 | | | |
| SERIES 250 | | | | | | | | | | | | | | | | | | | | | |
| IDROSOM 6/250 | 1,5 | 1,1 | 2" | H (m) | 40 | | | | | | | 35 | 33 | 32 | 29 | 26 | 23 | 19 | 14 | 7 | |
| IDROSOM 8/250 | 2 | 1,5 | 2" | | 53 | | | | | | | | 47 | 44 | 42 | 39 | 35 | 30 | 25 | 18 | 9 |
| IDROSOM 12/250 | 3 | 2,2 | 2" | | 79 | | | | | | | | 70 | 66 | 63 | 58 | 52 | 45 | 38 | 27 | 14 |
| IDROSOM 17/250 | 4 | 3 | 2" | | 112 | | | | | | | | 99 | 94 | 89 | 82 | 74 | 64 | 54 | 39 | 19 |
| IDROSOM 22/250 | 5,5 | 4 | 2" | | 145 | | | | | | | | 129 | 122 | 115 | 106 | 95 | 82 | 69 | 50 | 25 |
| IDROSOM 30/250 | 7,5 | 5,5 | 2" | | 197 | | | | | | | | 175 | 165 | 156 | 144 | 129 | 112 | 94 | 68 | 33 |
| IDROSOM 40/250 | 10 | 7,5 | 2" | | 262 | | | | | | | | 233 | 220 | 208 | 192 | 172 | 149 | 125 | 90 | 44 |

Motor and pump end can be supplied coupled exclusively with "S" series motors

PERFORMANCE DATA - MOTORS - 2 poles 50 Hz

| Code | Voltage | Number of phases | Capacitor | P2 | | Axial load | Rotation | Nominal current | Start current | Start Torque | Efficiency % | Power factor | Size of cable mm ² | Length of cable m |
|--|---------|------------------|-----------|------|-------------------|------------|----------------|-----------------|----------------|----------------|----------------|--------------|----------------------------------|----------------------|
| | V | | μF | hp | kW | F | η _N | I _N | I _A | M _A | η _N | cos φ | | |
| | | | | N | min ⁻¹ | A | A | Nm | | | | | | |
| "S" SERIES COOLANT FILLED SUBMERSIBLE MOTORS - for 4" boreholes | | | | | | | | | | | | | | |
| M4M05 | 230 | 1 | 20 | 0,5 | 0,37 | 2000 | 2870 | 3,6 | 12,5 | 1,1 | 52 | 0,89 | 4 x 1 | 2 |
| M4T05 | 400 | 3 | | | | | 2900 | 1,8 | 9 | 6,1 | 57 | 0,5 | | |
| M4M075 | 230 | 1 | 20 | 0,75 | 0,55 | 2000 | 2800 | 4,4 | 12,5 | 1,1 | 60 | 0,93 | 4 x 1 | 2 |
| M4T075 | 400 | 3 | | | | | 2850 | 2 | 9 | 6,1 | 64 | 0,7 | | |
| M4M10 | 230 | 1 | 25 | 1 | 0,75 | 2000 | 2810 | 6 | 17,4 | 1,42 | 59 | 0,93 | 4 x 1 | 2 |
| M4T10 | 400 | 3 | | | | | 2805 | 2,3 | 9 | 6,1 | 66 | 0,75 | | |
| M4M15 | 230 | 1 | 31,5 | 1,5 | 1,1 | 2000 | 2800 | 8 | 22,9 | 2,2 | 65 | 0,92 | 4 x 1 | 2 |
| M4T15 | 400 | 3 | | | | | 2800 | 3,2 | 12,8 | 12,1 | 68 | 0,74 | | |
| M4M20 | 230 | 1 | 40 | 2 | 1,5 | 2000 | 2820 | 11 | 37,4 | 2,3 | 67 | 0,9 | 4 x 1,5 | 2 |
| M4T20 | 400 | 3 | | | | | 2815 | 4,2 | 13,6 | 16,3 | 71 | 0,76 | 4 x 1 | |
| M4M30/2 | 230 | 1 | 55 | 3 | 2,2 | 2000 | 2830 | 15,7 | 48 | 3,3 | 68 | 0,91 | 4 x 1,5 | 2 |
| M4M30H | 230 | 1 | | | | | 4500 | | | | | | | |
| M4T30 | 400 | 3 | | | | | 2800 | 5,7 | 28 | 23,9 | 72 | 0,78 | 4 x 1 | |
| M4T30H | 400 | 3 | | | | | 5000 | | | | | | | |
| M4T40 | 400 | 3 | | 4 | 3 | 5000 | 2815 | 8 | 35,2 | 27,9 | 72 | 0,73 | 4 x 1 | 2 |
| M4T55 | 400 | 3 | | 5,5 | 4 | 5000 | 2860 | 10 | 51,7 | 37,2 | 78 | 0,75 | 4 x 1,5 | 2 |
| M4T75 | 400 | 3 | | 7,5 | 5,5 | 5000 | 2840 | 12,5 | 67 | 48 | 80 | 0,85 | 4 x 1,5 | 4 |
| M4T100 | 400 | 3 | | 10 | 7,5 | 5000 | 2850 | 16,7 | 91 | 66,5 | 80 | 0,8 | 4 x 1,5 | 4 |
| "E" SERIES COOLANT FILLED SUBMERSIBLE MOTORS - for 4" boreholes | | | | | | | | | | | | | | |
| MYE4M075 | 230 | 1 | 25 | 0,75 | 0,55 | 2000 | 2810 | 4,7 | 16,5 | 1,3 | 57 | 0,88 | 4 x 1,5 | 1,7 |
| MYE4M10 | 230 | 1 | 35 | 1 | 0,75 | 2000 | 2825 | 5,9 | 18,9 | 1,72 | 62 | 0,9 | 4 x 1,5 | 1,7 |
| MYE4T10 | 400 | 3 | | | | | 2825 | 2,5 | 9,4 | 5,1 | 63 | 0,77 | | |
| MYE4M15 | 230 | 1 | 40 | 1,5 | 1,1 | 2000 | 2840 | 8,3 | 26,2 | 2,3 | 64 | 0,91 | 4 x 1,5 | 1,7 |
| MYE4T15 | 400 | 3 | | | | | 2825 | 3,4 | 15,5 | 9,64 | 68 | 0,69 | | |
| MYE4M20 | 230 | 1 | 60 | 2 | 1,5 | 2000 | 2845 | 10,7 | 35 | 3,27 | 66 | 0,93 | 4 x 1,5 | 1,7 |
| MYE4T20 | 400 | 3 | | | | | 2835 | 4,8 | 18 | 10 | 71 | 0,63 | | |

Electric submersible pumps IDROSOM series 60

for 4" boreholes

PERFORMANCE DATA - 2 poles 50 Hz

| Radial impeller  | Pump Code | Motor | | Version | | P2 | | A | Flow | | DNM | Dimensions (mm) | | | Cable m | Weight kg |
|---|-----------|----------|--------|---------|---------|------|------|------|--------------|----------------|-----|-----------------|-----|----|------------|--------------|
| | | Code | Series | | | hp | kW | | l/min | m | | A | B | C | | |
| IDROSOM 8/60 | P60/08 | M4M05 | S | 230 V | 1-phase | 0,5 | 0,37 | 3,6 | 10 - 30 - 60 | 48 - 41 - 16 | 1"½ | 746 | 346 | 95 | 2 | 12 |
| | | M4T05 | S | 400 V | 3-phase | | | 1,8 | | | | | | | | 12,1 |
| IDROSOM 12/60 | P60/12 | M4M075 | S | 230 V | 1-phase | 0,75 | 0,55 | 4,4 | 10 - 30 - 60 | 73 - 62 - 24 | 1"½ | 837 | 346 | 95 | 2 | 12,6 |
| | | MYE4M075 | E | | 1-phase | | | 4,7 | | | | | | | | 11,3 |
| | | M4T075 | S | 400 V | 3-phase | | | 2 | | | | | | | | 12,7 |
| IDROSOM 15/60 | P60/15 | M4M10 | S | 230 V | 1-phase | 1 | 0,75 | 6 | 10 - 30 - 60 | 90 - 78 - 30 | 1"½ | 935 | 376 | 95 | 2 | 14,4 |
| | | MYE4M10 | E | | 1-phase | | | 5,9 | | | | | | | | 12,9 |
| | | M4T10 | S | 400 V | 3-phase | | | 2,3 | | | | | | | | 13,1 |
| | | MYE4T10 | E | | 3-phase | | | 2,5 | | | | | | | | 12,9 |
| IDROSOM 23/60 | P60/23 | M4M15 | S | 230 V | 1-phase | 1,5 | 1,1 | 8 | 10 - 30 - 60 | 137 - 119 - 45 | 1"½ | 1145 | 406 | 95 | 2 | 16,9 |
| | | MYE4M15 | E | | 1-phase | | | 8,3 | | | | | | | | 15,9 |
| | | M4T15 | S | 400 V | 3-phase | | | 3,2 | | | | | | | | 15,5 |
| | | MYE4T15 | E | | 3-phase | | | 3,4 | | | | | | | | 15 |
| IDROSOM 30/60 | P60/30 | M4M20 | S | 230 V | 1-phase | 2 | 1,5 | 11 | 10 - 30 - 60 | 179 - 155 - 59 | 1"½ | 1396 | 456 | 95 | 2 | 20,4 |
| | | MYE4M20 | E | | 1-phase | | | 10,7 | | | | | | | | 18,6 |
| | | M4T20 | S | 400 V | 3-phase | | | 4,2 | | | | | | | | 18,1 |
| | | MYE4T20 | E | | 3-phase | | | 4,8 | | | | | | | | 17,2 |
| IDROSOM 43/60 | P60/43 | M4M30H | S | 230 V | 1-phase | 3 | 2,2 | 15,7 | 10 - 30 - 60 | 257 - 222 - 84 | 1"½ | 1782 | 506 | 95 | 2 | 24,5 |
| | | M4T30H | S | 400 V | 3-phase | | | 5,7 | | | | | | | | 25,5 |

Motor and pump end can be supplied coupled exclusively with "S" series motors



SUPPLIED WITH

Capacitor
(for single-phase versions, "S" series)



OPTIONS

10 meters cable

20 meters cable

30 meters cable



Available up to 1.1 kW single-phase and three-phase up to 3 kW

ACCESSORIES

Code

Description

05405031

Non-return threaded valve 1"½ GAS

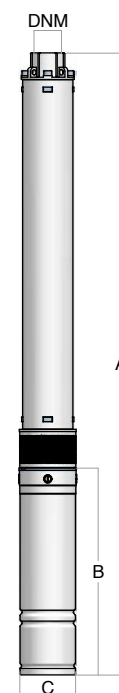

PERFORMANCE CURVES - 2 poles 50 Hz

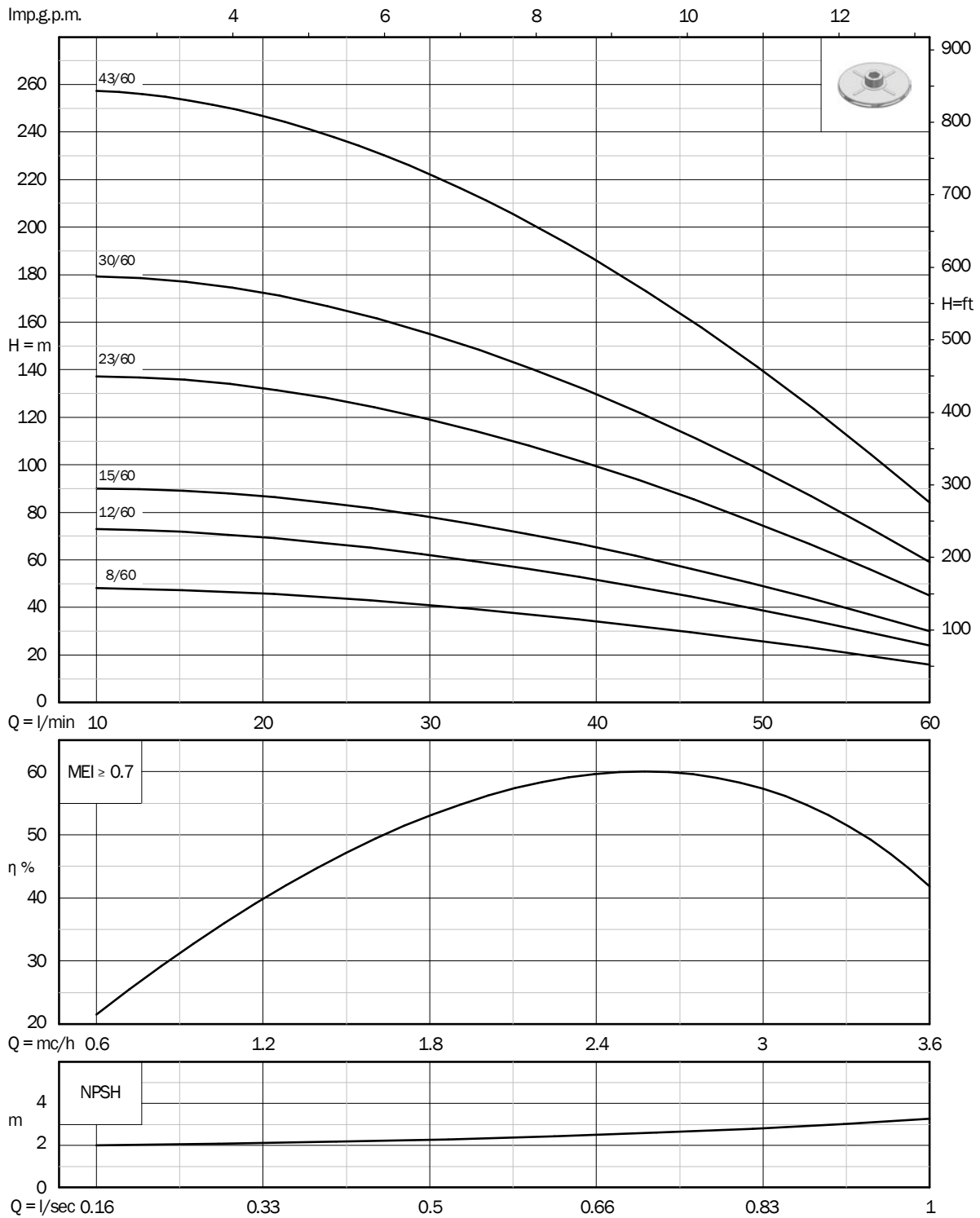

Electric submersible pumps IDROSOM series 100

for 4" boreholes

PERFORMANCE DATA - 2 poles 50 Hz

| Radial impeller  | Pump Code | Motor | | Version | | P2 | | A | Flow | | DNM | Dimensions (mm) | | | Cable | Weight | | |
|---|-----------|----------|--------|---------|---------|------|------|------|---------------|----------------|-----|-----------------|-----|----|-------|--------|-----|------|
| | | Code | Series | | | hp | kW | | l/min | m | | A | B | C | | | m | kg |
| IDROSOM 7/100 | P100/07 | M4M075 | S | 230 V | 1-phase | 0,75 | 0,55 | 4,4 | 20 - 60 - 100 | 44 - 36 - 14 | 1"½ | 748 | 346 | 95 | 2 | 11,9 | | |
| | | MYE4M075 | E | | | | | 4,7 | | | | 733 | 331 | | | | 1,7 | 10,6 |
| | | M4T075 | S | 400 V | 3-phase | | | 2 | | | | 748 | 346 | | | | 2 | 12 |
| IDROSOM 9/100 | P100/09 | M4M10 | S | 230 V | 1-phase | 1 | 0,75 | 6 | 20 - 60 - 100 | 55 - 46 - 18 | 1"½ | 830 | 376 | 95 | 2 | 13,6 | | |
| | | MYE4M10 | E | | | | | 5,9 | | | | 810 | 356 | | | | 1,7 | 12,1 |
| | | M4T10 | S | 400 V | 3-phase | | | 2,3 | | | | 800 | 346 | | | | 2 | 12,4 |
| | | MYE4T10 | E | | | | | 2,5 | | | | 810 | 356 | | | | 1,7 | 12,2 |
| IDROSOM 14/100 | P100/14 | M4M15 | S | 230 V | 1-phase | 1,5 | 1,1 | 8 | 20 - 60 - 100 | 86 - 72 - 28 | 1"½ | 990 | 406 | 95 | 2 | 15,8 | | |
| | | MYE4M15 | E | | | | | 8,3 | | | | 970 | 386 | | | | 1,7 | 14,8 |
| | | M4T15 | S | 400 V | 3-phase | | | 3,2 | | | | 960 | 376 | | | | 2 | 14,4 |
| | | MYE4T15 | E | | | | | 3,4 | | | | 955 | 371 | | | | 1,7 | 13,9 |
| IDROSOM 18/100 | P100/18 | M4M20 | S | 230 V | 1-phase | 2 | 1,5 | 11 | 20 - 60 - 100 | 110 - 91 - 36 | 1"½ | 1144 | 456 | 95 | 2 | 18,6 | | |
| | | MYE4M20 | E | | | | | 10,7 | | | | 1124 | 436 | | | | 1,7 | 16,8 |
| | | M4T20 | S | 400 V | 3-phase | | | 4,2 | | | | 1346 | 406 | | | | 2 | 16,4 |
| | | MYE4T20 | E | | | | | 4,8 | | | | 1326 | 386 | | | | 1,7 | 15,5 |
| IDROSOM 27/100 | P100/27 | M4M30/2 | S | 230 V | 1-phase | 3 | 2,2 | 15,7 | 20 - 60 - 100 | 167 - 137 - 53 | 1"½ | 1470 | 506 | 95 | 2 | 23 | | |
| | | M4T30 | S | 400 V | 3-phase | | | 5,7 | | | | 1420 | 456 | | | 20,3 | | |
| IDROSOM 36/100 | P100/36 | M4T40 | S | 400 V | 3-phase | 4 | 3 | 8 | 20 - 60 - 100 | 220 - 182 - 71 | 1"½ | 1729 | 531 | 95 | 2 | 24,6 | | |
| IDROSOM 48/100 | P100/48 | M4T55 | S | 400 V | 3-phase | 5,5 | 4 | 10 | 20 - 60 - 100 | 295 - 242 - 96 | 1"½ | 2167 | 587 | 95 | 2 | 30,4 | | |

Motor and pump end can be supplied coupled exclusively with "S" series motors



SUPPLIED WITH

Capacitor
(for single-phase versions, "S" series)



OPTIONS

10 meters cable

20 meters cable

30 meters cable



Available up to 1.1 kW single-phase and three-phase up to 3 kW

ACCESSORIES

Code

Description

05405031

Non-return threaded valve 1"½ GAS

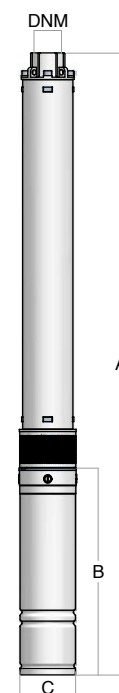

PERFORMANCE CURVES - 2 poles 50 Hz

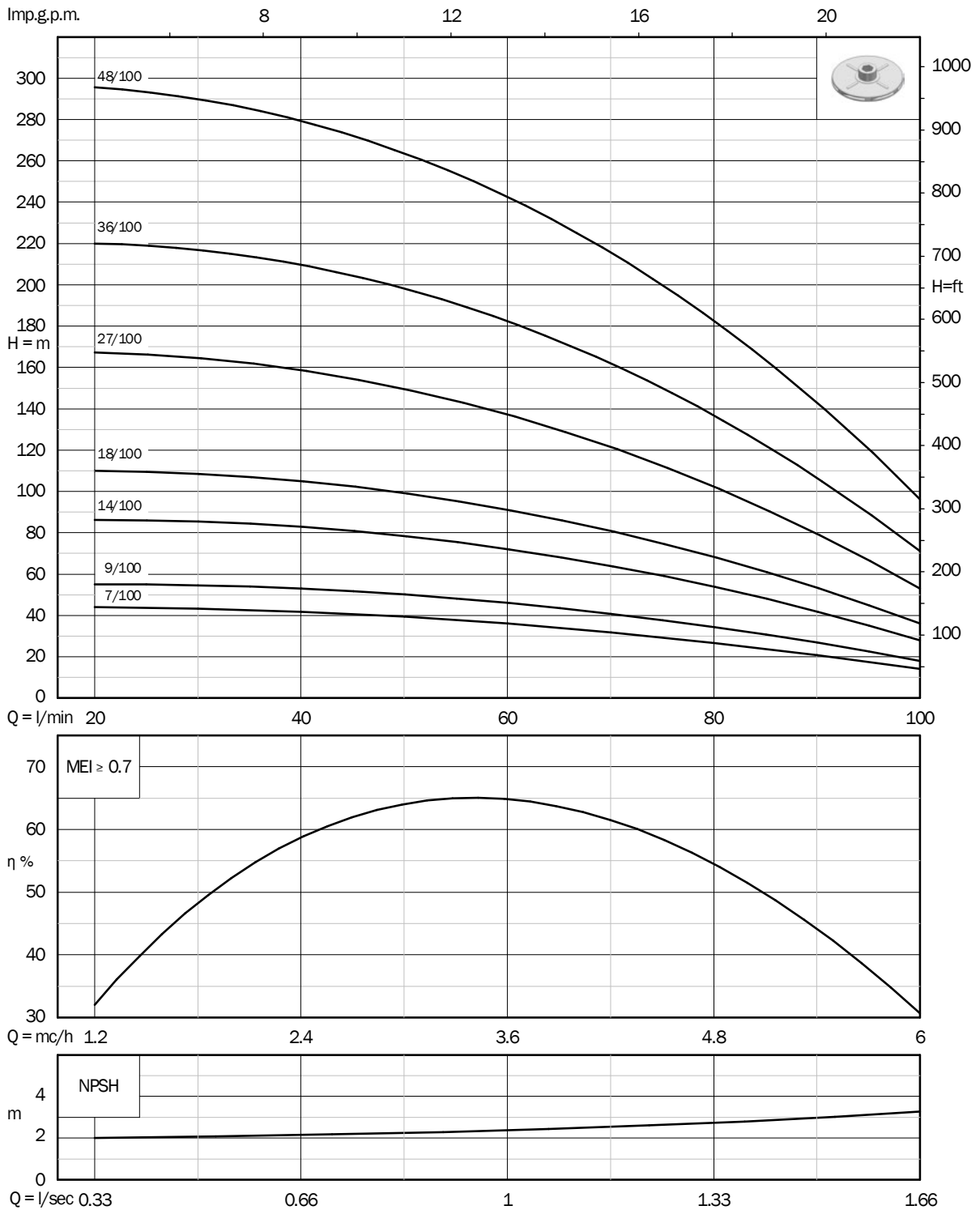

Electric submersible pumps IDROSOM series 180

for 4" boreholes

PERFORMANCE DATA - 2 poles 50 Hz

| Radial impeller  | Pump Code | Motor | | Versione | | P2 | | A | Flow | | DNM | Dimensions (mm) | | | Cable | Weight |
|---|-----------|---------|--------|----------|---------|-----|------|-------|----------------|----------------|---------|-----------------|-----|----|-------|--------|
| | | Code | Series | | | hp | kW | | l/min | m | | A | B | C | | |
| | | | | 230 V | 1-phase | | | 400 V | | | 3-phase | | | | | |
| IDROSOM 6/180 | P180/06/1 | M4M10 | S | 230 V | 1-phase | 1 | 0,75 | 6 | 75 - 120 - 180 | 32 - 26 - 12 | 2" | 817 | 376 | 95 | 2 | 13,5 |
| | | MYE4M10 | E | | | | | 5,9 | | | | 797 | 356 | | | |
| | | M4T10 | S | 400 V | 3-phase | | | 2,3 | | | | 787 | 346 | | | |
| | | MYE4T10 | E | | | | | 2,5 | | | | 797 | 356 | | | |
| IDROSOM 9/180 | P180/09/1 | M4M15 | S | 230 V | 1-phase | 1,5 | 1,1 | 8 | 75 - 120 - 180 | 48 - 38 - 18 | 2" | 951 | 406 | 95 | 2 | 15,5 |
| | | MYE4M15 | E | | | | | 8,3 | | | | 931 | 386 | | | |
| | | M4T15 | S | 400 V | 3-phase | | | 3,2 | | | | 921 | 376 | | | |
| | | MYE4T15 | E | | | | | 3,4 | | | | 916 | 371 | | | |
| IDROSOM 12/180 | P180/12/1 | M4M20 | S | 230 V | 1-phase | 2 | 1,5 | 11 | 75 - 120 - 180 | 64 - 51 - 23 | 2" | 1104 | 456 | 95 | 2 | 18,3 |
| | | MYE4M20 | E | | | | | 10,7 | | | | 1084 | 436 | | | |
| | | M4T20 | S | 400 V | 3-phase | | | 4,2 | | | | 1054 | 406 | | | |
| | | MYE4T20 | E | | | | | 4,8 | | | | 1034 | 386 | | | |
| IDROSOM 17/180 | P180/17/1 | M4M30/2 | S | 230 V | 1-phase | 3 | 2,2 | 15,7 | 75 - 120 - 180 | 91 - 72 - 33 | 2" | 1370 | 506 | 95 | 2 | 21,4 |
| | | M4T30 | S | 400 V | 3-phase | | | 5,7 | | | | 1320 | 456 | | | 19,7 |
| IDROSOM 24/180 | P180/24/1 | M4T40 | S | 400 V | 3-phase | 4 | 3 | 8 | 75 - 120 - 180 | 128 - 102 - 46 | 2" | 1637 | 531 | 95 | 2 | 23,7 |
| IDROSOM 31/180 | P180/31/1 | M4T55 | S | 400 V | 3-phase | 5,5 | 4 | 10 | 75 - 120 - 180 | 165 - 131 - 59 | 2" | 1978 | 587 | 95 | 2 | 29,4 |
| IDROSOM 42/180 | P180/42/1 | M4T75 | S | 400 V | 3-phase | 7,5 | 5,5 | 12,5 | 75 - 120 - 180 | 223 - 177 - 80 | 2" | 2448 | 677 | 95 | 4 | 36,4 |

Motor and pump end can be supplied coupled exclusively with "S" series motors



SUPPLIED WITH

Capacitor
(for single-phase versions, "S" series)



OPTIONS

10 meters cable

20 meters cable

30 meters cable



Available up to 1.1 kW single-phase and three-phase up to 3 kW

ACCESSORIES

Code

Description

05405035

Non-return threaded valve 2" GAS

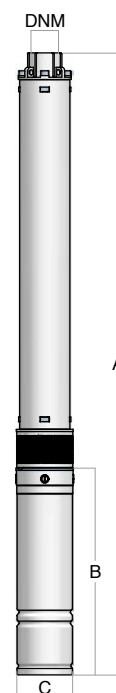

PERFORMANCE CURVES - 2 poles 50 Hz

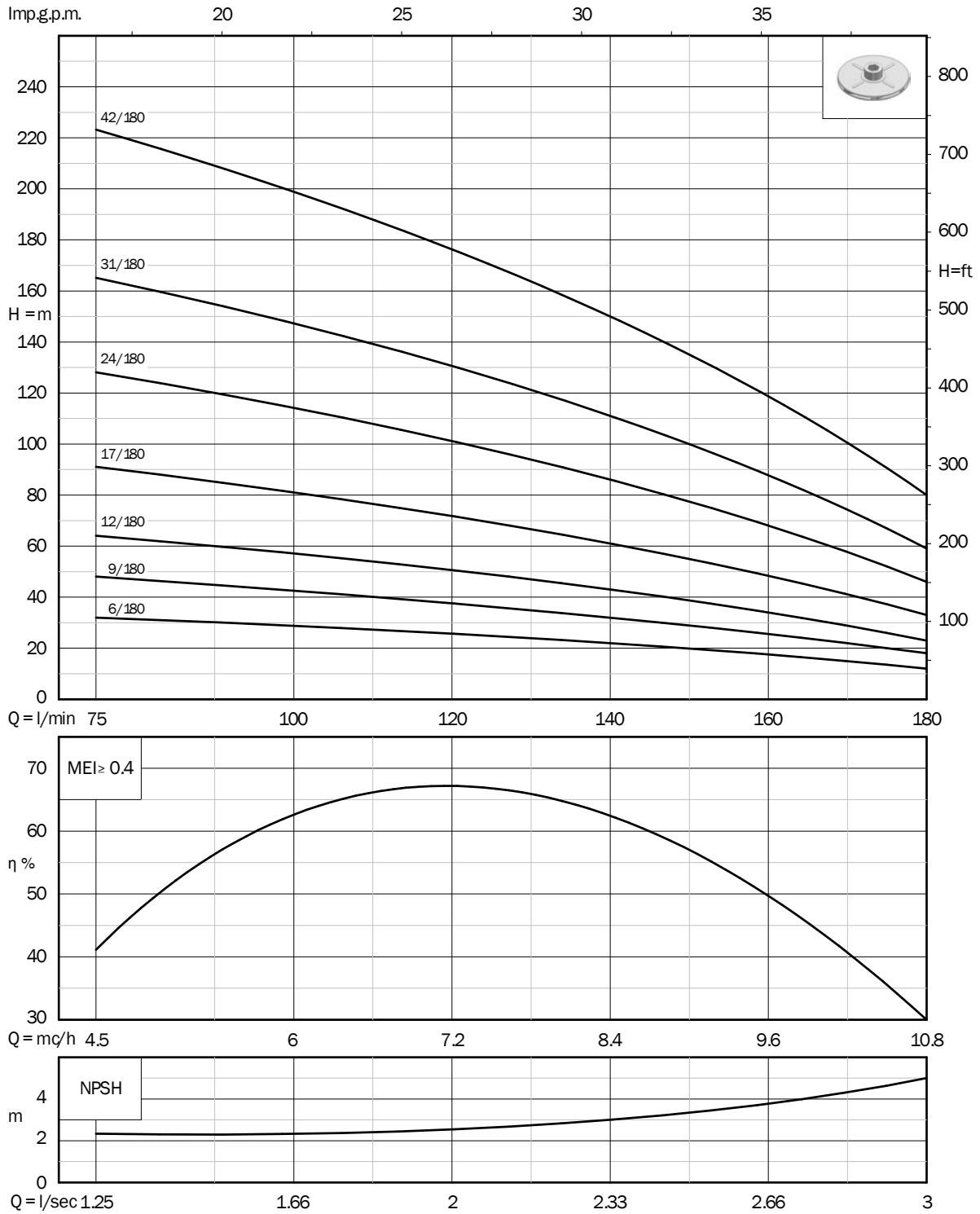

Electric submersible pumps IDROSOM series 250

for 4" boreholes

PERFORMANCE DATA - 2 poles 50 Hz

| Radial impeller  | Pump Code | Motor | | Version | | P2 | | A | Flow | | DNM | Dimensions (mm) | | | Cable m | Weight kg | | |
|---|-----------|---------|--------|---------|---------|-----|-----|------|----------------|----------------|-----|-----------------|-----|----|------------|--------------|-----|------|
| | | Code | Series | | | hp | kW | | l/min | m | | A | B | C | | | | |
| IDROSOM 6/250 | P250/06 | M4M15 | S | 230 V | 1-phase | 1,5 | 1,1 | 8 | 75 - 160 - 250 | 35 - 26 - 7 | 2" | 876 | 406 | 95 | 2 | 15 | | |
| | | MYE4M15 | E | | | | | 8,3 | | | | 856 | 386 | | | | 1,7 | 14 |
| | | M4T15 | S | 400 V | 3-phase | | | 3,2 | | | | 846 | 376 | | | | 2 | 13,6 |
| | | MYE4T15 | E | | | | | 3,4 | | | | 841 | 371 | | | | 1,7 | 13,1 |
| IDROSOM 8/250 | P250/08 | M4M20 | S | 230 V | 1-phase | 2 | 1,5 | 11 | 75 - 160 - 250 | 47 - 35 - 9 | 2" | 1005 | 456 | 95 | 2 | 17,7 | | |
| | | MYE4M20 | E | | | | | 10,7 | | | | 985 | 436 | | | | 1,7 | 15,9 |
| | | M4T20 | S | 400 V | 3-phase | | | 4,2 | | | | 955 | 406 | | | | 2 | 15,4 |
| | | MYE4T20 | E | | | | | 4,8 | | | | 935 | 386 | | | | 1,7 | 14,5 |
| IDROSOM 12/250 | P250/12 | M4M30/2 | S | 230 V | 1-phase | 3 | 2,2 | 15,7 | 75 - 160 - 250 | 70 - 52 - 14 | 2" | 1213 | 506 | 95 | 2 | 20,2 | | |
| | | M4T30 | S | 400 V | 3-phase | | | 5,7 | | | | 1163 | 456 | | | 18,5 | | |
| IDROSOM 17/250 | P250/17 | M4T40 | S | 400 V | 3-phase | 4 | 3 | 8 | 75 - 160 - 250 | 99 - 74 - 19 | 2" | 1479 | 531 | 95 | 2 | 22,8 | | |
| IDROSOM 22/250 | P250/22 | M4T55 | S | 400 V | 3-phase | 5,5 | 4 | 10 | 75 - 160 - 250 | 129 - 95 - 25 | 2" | 1732 | 587 | 95 | 2 | 27,2 | | |
| IDROSOM 30/250 | P250/30 | M4T75 | S | 400 V | 3-phase | 7,5 | 5,5 | 12,5 | 75 - 160 - 250 | 175 - 129 - 33 | 2" | 2180 | 677 | 95 | 4 | 34,7 | | |
| IDROSOM 40/250 | P250/40 | M4T100 | S | 400 V | 3-phase | 10 | 7,5 | 16,7 | 75 - 160 - 250 | 233 - 172 - 44 | 2" | 2655 | 757 | 95 | 4 | 40,5 | | |

Motor and pump end can be supplied coupled exclusively with "S" series motors



SUPPLIED WITH

Capacitor
(for single-phase versions, "S" series)



OPTIONS

10 meters cable

20 meters cable

30 meters cable



Available up to 1.1 kW single-phase and three-phase up to 3 kW

ACCESSORIES

Code

Description

05405035

Non-return threaded valve 2" GAS

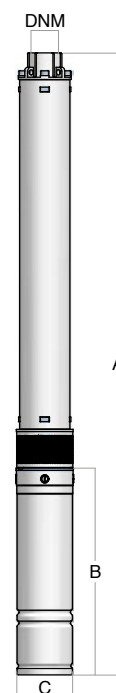

PERFORMANCE CURVES - 2 poles 50 Hz

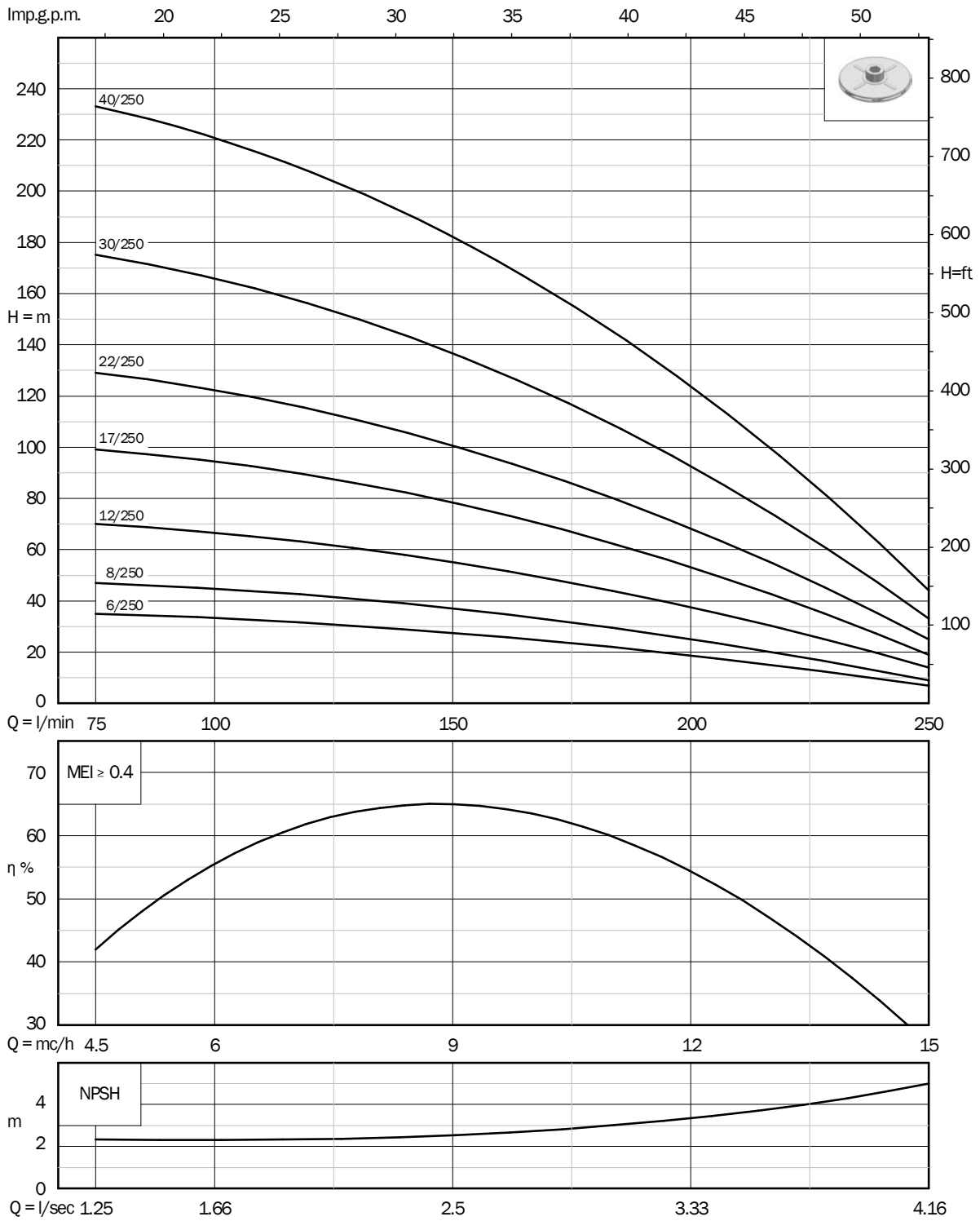

IDROSAND 6"

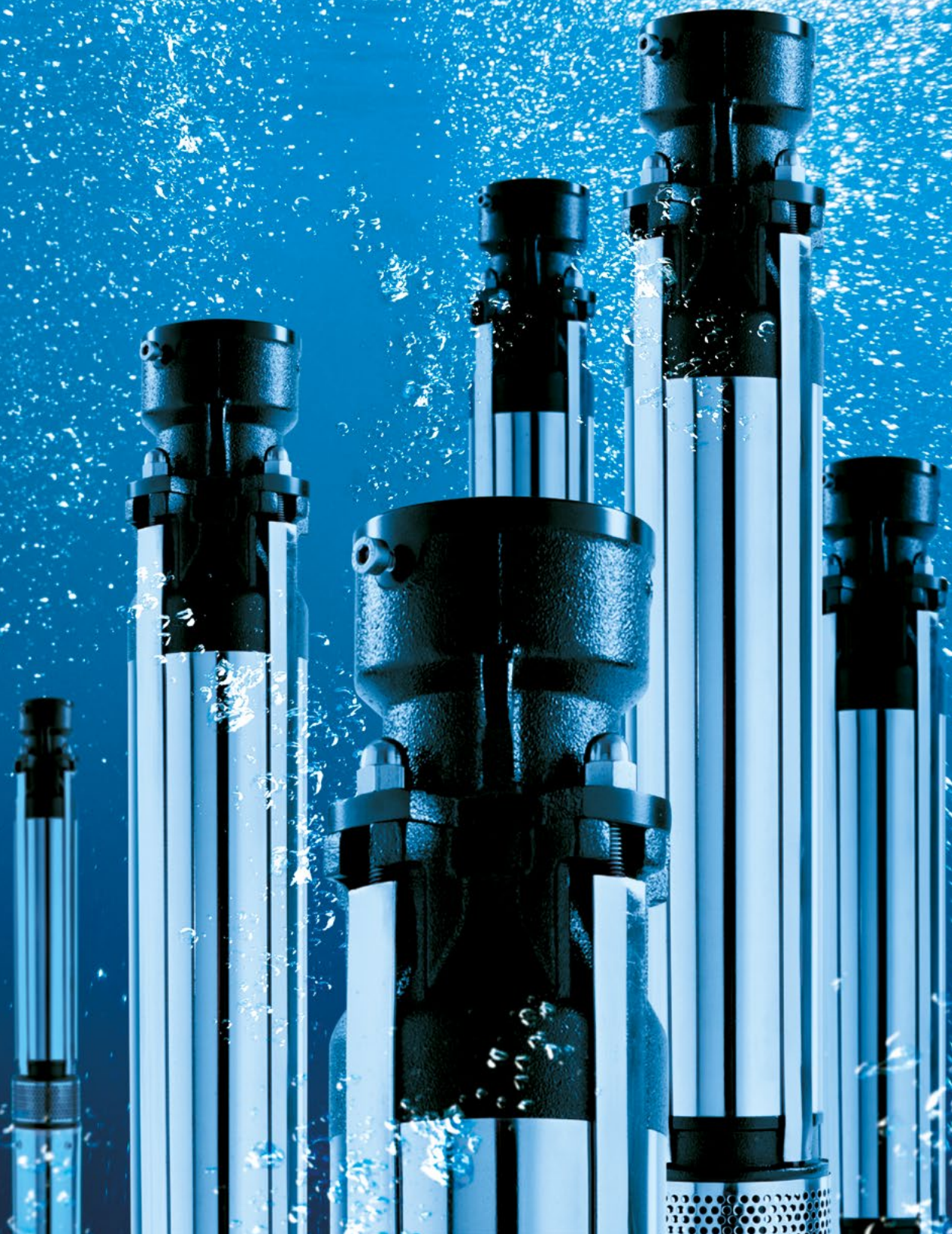

Electric submersible pumps IDROSAND

for 6" boreholes



APPLICATION

To pump water from boreholes

To pressurize civil, agricultural, industrial and fire-fighting plants

Irrigation

CONSTRUCTION

Pumps designed to operate in the most arduous conditions, offering reliability even in applications with high sand content (IDROSAND+ up to 450 g/m³)

Coolant filled, asynchronous, rewindable electric AC motor with short circuit rotor. Insulation Class F. (4" motors).
Water filled, asynchronous, rewindable electric AC motor with short circuit rotor. Insulation Class Y. (6" motors).

Shafts machined on support bushes and mechanical seals location

Both shaft and coupling meet NEMA standards

APPLICATION RANGE

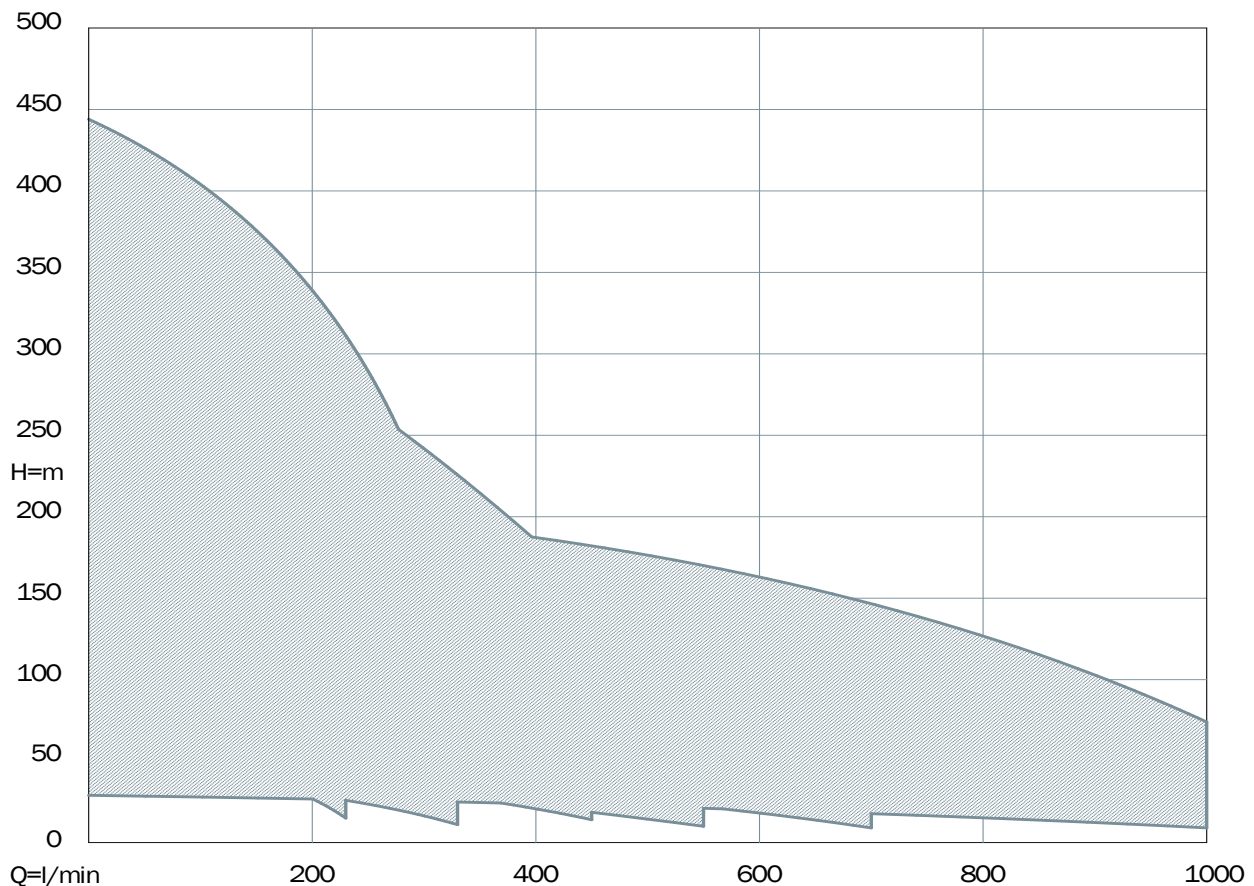

Electric submersible pumps IDROSAND

for 6" boreholes



The electric pumps **IDROSAND** are designed to operate in the most arduous conditions, offering reliability even in applications with high sand content (**IDROSAND+** up to 450 g/m³).



APPLICATION FEATURES - PUMP END

| | IDROSAND | | | IDROSAND+ | | |
|--|----------|--------|--------|-----------|--------|-------|
| | /230 | /330 | /530 | /400 | /700 | /900 |
| Minimum depth of the liquid to be pumped (m) | 0,8 | | | | | |
| Maximum temperature of the water to be pumped (°C) | 60 | | | | | |
| PH of the liquid pumped | 6 - 10 | | | | | |
| Maximum sand content (g/m ³) | 200 | | | 300 | 450 | |
| Suitable to operate horizontally (included) | 24/230 | 23/330 | 17/530 | 15/400 | 13/700 | 8/900 |

MATERIALS - PUMP END

| | IDROSAND | | | IDROSAND+ | | |
|-------------------------|--|------|---------------------------------|-------------------------|------|------|
| | /230 | /330 | /530 | /400 | /700 | /900 |
| Head and suction body | Mechanical cast iron EN GJL-200 | | | | | |
| Casing / Diffuser body | Stainless steel AISI304 | | Mechanical cast iron EN GJL-200 | Stainless steel AISI304 | | |
| Tie-rods | Stainless steel AISI304 | | Steel | Stainless steel AISI304 | | |
| Shaft | Stainless steel AISI420B | | | | | |
| Coupling | Stainless steel AISI416B | | | | | |
| Impellers and diffusers | Noryl® reinforced with fibre-glass, certified for drinking water and AISI 304 stainless steel wear rings | | | | | |
| Diffuser bush | | | | Anti-sand rubber | | |
| Top bush | Desmopan® with rotating element in chromium-plated brass | | | | | |
| Check valve | Stainless steel AISI304 | | | | | |

APPLICATION FEATURES - MOTOR

| | MOTOR | |
|--|---------------|-----|
| | 4" S series | 6" |
| IP rating | IP68 | |
| Duty | Continuous S1 | |
| Maximum immersion depth (m) | 150 | 200 |
| Maximum number of starts per hour | 30 | 20 |
| Maximum temperature of the water pumped (°C) | 35 | 30 |
| PH of the liquid pumped | 6 - 10 | |
| Suitable for inverter drive | All | |
| Suitable to operate horizontally (Included) | 5,5 hp | All |

MATERIALS - MOTOR

| | MOTOR | |
|-----------------|-------------------------|--|
| | 4" S series | 6" |
| Casing | Stainless Steel AISI304 | |
| Shaft Terminal | Stainless Steel AISI303 | Stainless Steel AISI420B |
| Upper body | Brass OT58 | Mechanical cast iron with electrophoresis paint EN GJL-250 or brass OT58 |
| Elastomers | NBR rubber | |
| Mechanical seal | Graphite and alumina | |
| Foot | | ABS |
| Cable | PVC | PVC ACS AD8 (for permanent immersion in drinking water) |



PERFORMANCE DATA - PUMP ENDS - 2 poles 50 Hz

| Semi-axial impeller  | P2 | | DNM | Q | Flow | | | | | | | | | | | |
|---|------|------|-----|-------------------|------|-----|-----|------|-----|------|-----|-----|-----|-----|-----|------|
| | hp | kW | | m ³ /h | 0 | 21 | 24 | 27 | 30 | 33 | 36 | 39 | 42 | 48 | 54 | 60 |
| | | | | l/min | 0 | 350 | 400 | 450 | 500 | 550 | 600 | 650 | 700 | 800 | 900 | 1000 |
| SERIES 700 | | | | | | | | | | | | | | | | |
| IDROSAND+ 3/700 | 5,5 | 4 | 3" | H (m) | 41 | 34 | 31 | 28 | 25 | 22 | 18 | 14 | 9 | | | |
| IDROSAND+ 5/700 | 7,5 | 5,5 | 3" | | 68 | 56 | 51 | 46 | 41 | 35 | 28 | 21 | 14 | | | |
| IDROSAND+ 6/700 | 10 | 7,5 | 3" | | 84 | 65 | 59 | 54 | 48 | 42 | 34 | 27 | 17 | | | |
| IDROSAND+ 8/700 | 12,5 | 9,2 | 3" | | 113 | 89 | 83 | 76 | 69 | 60 | 50 | 40 | 29 | | | |
| IDROSAND+ 10/700 | 15 | 11 | 3" | | 141 | 112 | 104 | 96 | 86 | 75 | 62 | 50 | 36 | | | |
| IDROSAND+ 13/700 | 20 | 15 | 3" | | 183 | 146 | 136 | 125 | 111 | 96 | 80 | 63 | 45 | | | |
| IDROSAND+ 16/700 | 25 | 18,5 | 3" | | 223 | 177 | 164 | 150 | 134 | 116 | 96 | 75 | 54 | | | |
| IDROSAND+ 19/700 | 30 | 22 | 3" | | 270 | 210 | 195 | 179 | 159 | 137 | 114 | 89 | 63 | | | |
| SERIES 900 | | | | | | | | | | | | | | | | |
| IDROSAND+ 2/900 | 5,5 | 4 | 3" | H (m) | 29 | | 24 | 23 | 22 | 21 | 20 | 19 | 18 | 16 | 13 | 9 |
| IDROSAND+ 3/900 | 7,5 | 5,5 | 3" | | 41 | | 37 | 36 | 35 | 33,5 | 32 | 30 | 28 | 24 | 19 | 13 |
| IDROSAND+ 4/900 | 10 | 7,5 | 3" | | 56 | | 50 | 48 | 46 | 44 | 42 | 40 | 38 | 33 | 26 | 18 |
| IDROSAND+ 5/900 | 12,5 | 9,2 | 3" | | 70 | | 63 | 61 | 59 | 56 | 54 | 51 | 48 | 42 | 33 | 23 |
| IDROSAND+ 6/900 | 15 | 11 | 3" | | 86 | | 76 | 73,5 | 71 | 68 | 65 | 62 | 59 | 51 | 41 | 29 |
| IDROSAND+ 8/900 | 20 | 15 | 3" | | 114 | | 101 | 98 | 95 | 91 | 87 | 83 | 78 | 68 | 55 | 38 |
| IDROSAND+ 10/900 | 25 | 18,5 | 3" | | 143 | | 127 | 123 | 119 | 114 | 109 | 104 | 98 | 85 | 68 | 48 |
| IDROSAND+ 12/900 | 30 | 22 | 3" | | 170 | | 152 | 147 | 142 | 137 | 131 | 125 | 118 | 103 | 83 | 58 |
| IDROSAND+ 15/900 | 40 | 30 | 3" | | 210 | | 190 | 183 | 177 | 170 | 163 | 156 | 147 | 127 | 102 | 74 |

Electric pumps supplied with 4" 'S' series motors up to 4 kW

PERFORMANCE DATA - MOTORS - 2 poles 50 Hz

| Type | Code | Voltage | Number of phases | P2 | | Axial load | Rotation | Nominal current | Start current | Start Torque | Efficiency % | Power factor | Size of cable mm ² | Length of cable m |
|---|-------------|---------|------------------|------|-------------------|------------|----------|-----------------|---------------|--------------|--------------|--------------|----------------------------------|----------------------|
| | | V | | hp | kW | F | η_N | I_N | I_A | M_A | η_N | cos ϕ | | |
| | | | | N | min ⁻¹ | A | A | Nm | | | | | | |
| WATER FILLED SUBMERSIBLE MOTORS for 6" boreholes | | | | | | | | | | | | | | |
| 6TA55 | M6TA55/2 | 400 | 3 | 5,5 | 4 | 8000 | 2900 | 10,6 | 55 | 34 | 81 | 0,7 | 4 x 4 | 3 |
| 6TA75 | M6TA75/2 | 400 | 3 | 7,5 | 5,5 | 8000 | 2840 | 12,8 | 55 | 34 | 81 | 0,77 | 4 x 4 | 3 |
| 6TA10 | M6TA10/2 | 400 | 3 | 10 | 7,5 | 8000 | 2830 | 17 | 73 | 51 | 80 | 0,79 | 4 x 4 | 3 |
| 6TA125 | M6TA125/2 | 400 | 3 | 12,5 | 9,2 | 8000 | 2830 | 21,5 | 90 | 69 | 80 | 0,78 | 4 x 4 | 3 |
| 6TA15 | M6TA15GH/1 | 400 | 3 | 15 | 11 | 8000 | 2850 | 24,8 | 110 | 80 | 81 | 0,79 | 4 x 4 | 3 |
| 6TAH15 | M6TA15HGH/1 | 400 | 3 | 15 | 11 | 18000 | 2850 | 24,8 | 110 | 80 | 81 | 0,79 | 4 x 4 | 3 |
| 6TA20 | M6TA20/2 | 400 | 3 | 20 | 15 | 18000 | 2880 | 30,7 | 140 | 63 | 85 | 0,8 | 4 x 4 | 3 |
| 6TA25 | M6TA25/2 | 400 | 3 | 25 | 18,5 | 18000 | 2870 | 39,6 | 160 | 74 | 85 | 0,8 | 4 x 6 | 3 |
| 6TA30 | M6TA30/2 | 400 | 3 | 30 | 22 | 18000 | 2900 | 46 | 180 | 97 | 86 | 0,8 | 4 x 6 | 3 |
| 6TA35 | M6TA35/2 | 400 | 3 | 35 | 26 | 18000 | 2910 | 55,5 | 270 | 130 | 88 | 0,76 | 4 x 6 | 3 |
| 6TA40 | M6TA40/2 | 400 | 3 | 40 | 30 | 18000 | 2900 | 62 | 270 | 130 | 87 | 0,8 | 4 x 6 | 3 |
| 6TA50 | M6TA50/2 | 400 | 3 | 50 | 37 | 18000 | 2900 | 81,8 | 360 | 155 | 87 | 0,8 | 4 x 6 | 3 |

Electric submersible pumps IDROSAND series 230

for 6" boreholes

PERFORMANCE DATA - 2 poles 50 Hz

| Radial impeller  | Pump Code | Motor Code | Version | | P2 | | A | Flow | | DNM | Dimensions (mm) | | | Cable m | Weight kg |
|---|-----------|-------------|---------|---------|------|-----|------|----------------|-----------------|-----|-----------------|-----|-----|---------|-----------|
| | | | | | hp | kW | | l/min | m | | A | B | C | | |
| | | | | | | | | | | | | | | | |
| IDROSAND 6/230 | P230/06 | M4M20 | 230 V | 1-phase | 2 | 1,5 | 11 | 90 - 150 - 230 | 51 - 40 - 15 | 2" | 1142 | 456 | 146 | 2 | 31 |
| | | M4T20 | 400 V | 3-phase | | | 4,2 | | | | 1092 | 406 | 146 | | |
| IDROSAND 8/230 | P230/08 | M4M30/2 | 230 V | 1-phase | 3 | 2,2 | 15,7 | 90 - 150 - 230 | 67 - 52 - 20 | 2" | 1264 | 506 | 146 | 2 | 34 |
| | | M4T30 | 400 V | 3-phase | | | 5,7 | | | | 1214 | 456 | 146 | | |
| IDROSAND 9/230 | P230/09 | M4M30/2 | 230 V | 1-phase | 3 | 2,2 | 15,7 | 90 - 150 - 230 | 75 - 59 - 24 | 2" | 1300 | 506 | 146 | 2 | 37,3 |
| | | M4T30 | 400 V | 3-phase | | | 5,7 | | | | 1250 | 456 | 146 | | |
| IDROSAND 11/230 | P230/11 | M4T40 | 400 V | 3-phase | 4 | 3 | 8 | 90 - 150 - 230 | 93 - 74 - 33 | 2" | 1397 | 531 | 146 | 2 | 36,8 |
| IDROSAND 14/230 | P230/14 | M4T55 | 400 V | 3-phase | 5,5 | 4 | 10 | 90 - 150 - 230 | 125 - 99 - 43 | 2" | 1561 | 587 | 146 | 2 | 41,9 |
| IDROSAND 17/230 | P230/17 | M6TA75/2 | 400 V | 3-phase | 7,5 | 5,5 | 12,8 | 90 - 150 - 230 | 150 - 118 - 52 | 2" | 1754 | 672 | 146 | 3 | 66 |
| IDROSAND 20/230 | P230/20 | M6TA75/2 | 400 V | 3-phase | 7,5 | 5,5 | 12,8 | 90 - 150 - 230 | 174 - 141 - 62 | 2" | 1862 | 672 | 146 | 3 | 67,7 |
| IDROSAND 24/230 | P230/24 | M6TA10/2 | 400 V | 3-phase | 10 | 7,5 | 17 | 90 - 150 - 230 | 207 - 166 - 77 | 2" | 2031 | 697 | 146 | 3 | 73,3 |
| IDROSAND 28/230 | P230/28 | M6TA10/2 | 400 V | 3-phase | 10 | 7,5 | 17 | 90 - 150 - 230 | 250 - 199 - 88 | 2" | 2175 | 697 | 146 | 3 | 75,9 |
| IDROSAND 34/230 | P230/34 | M6TA125/2 | 400 V | 3-phase | 12,5 | 9,2 | 21,5 | 90 - 150 - 230 | 307 - 241 - 106 | 2" | 2488 | 722 | 146 | 3 | 83,2 |
| IDROSAND 40/230 | P230/40 | M6TA15HGH/1 | 400 V | 3-phase | 15 | 11 | 24,8 | 90 - 150 - 230 | 361 - 288 - 132 | 2" | 2799 | 817 | 146 | 3 | 100,5 |

Electric pumps supplied with 4" 'S' series motors up to 4 kW



SUPPLIED WITH

Capacitor (single-phase versions)



OPTIONS FOR 6" MOTORS

Version for star-delta motors 400/690 V

Version with brass motor body

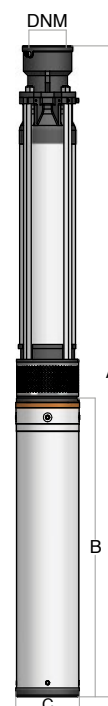

PERFORMANCE CURVES - 2 poles 50 Hz

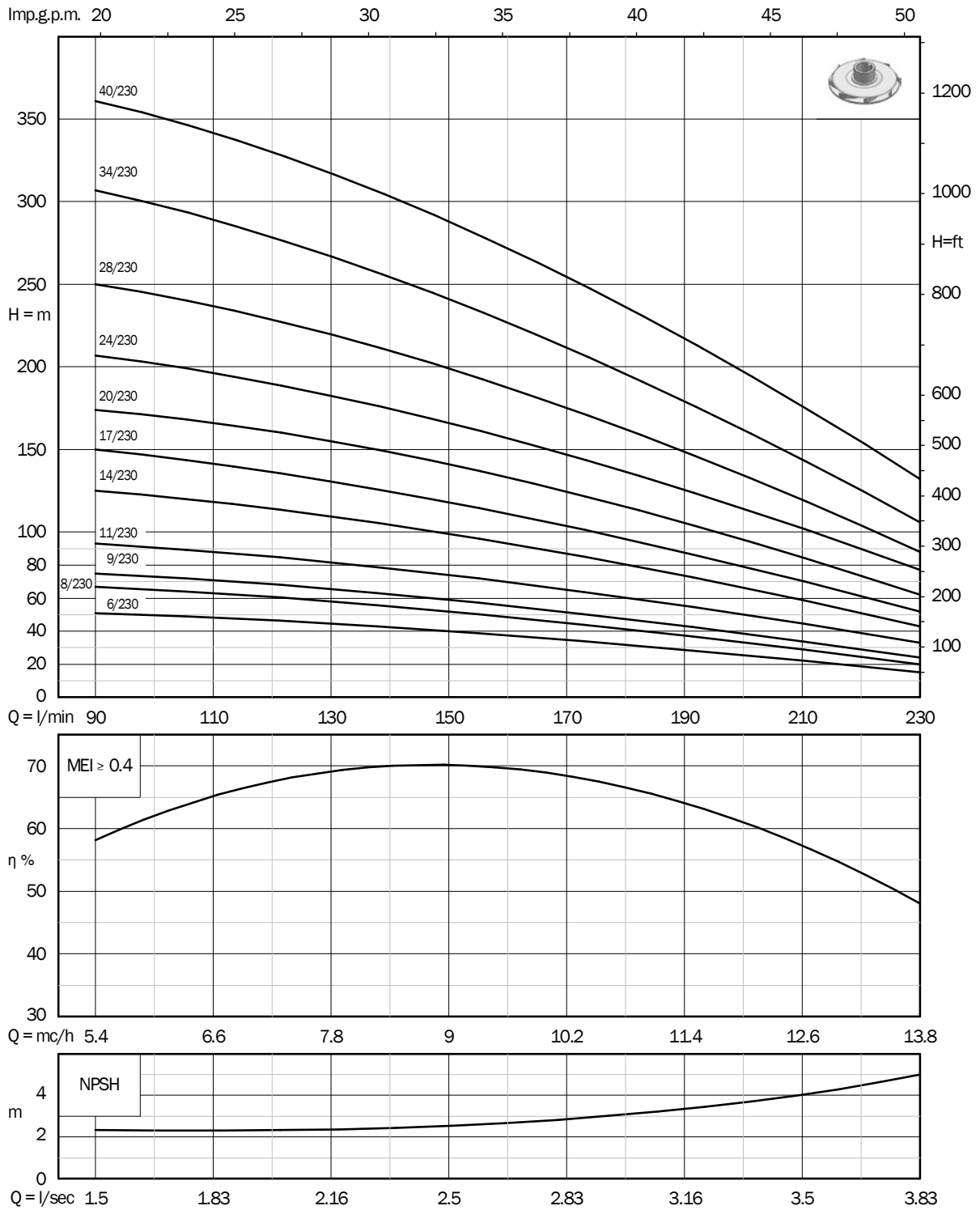

Electric submersible pumps IDROSAND series 330

for 6" boreholes

PERFORMANCE DATA - 2 poles 50 Hz

| Radial impeller  | Pump Code | Motor Code | Version | | P2 | | A | Flow | | DNM | Dimensions (mm) | | | Cable m | Weight kg |
|---|-----------|------------|---------|---------|------|------|------|-----------------|-----------------|-----|-----------------|-----|-----|---------|-----------|
| | | | | | hp | kW | | l/min | m | | A | B | C | | |
| | | | | | | | | | | | | | | | |
| IDROSAND 4/330 | P330/04 | M4M20 | 230 V | 1-phase | 2 | 1,5 | 11 | 150 - 250 - 330 | 34 - 24 - 11 | 2" | 1070 | 456 | 146 | 2 | 28,9 |
| | | M4T20 | 400 V | 3-phase | | | 4,2 | | | | 1020 | 406 | 146 | | |
| IDROSAND 5/330 | P330/05 | M4M30/2 | 230 V | 1-phase | 3 | 2,2 | 15,7 | 150 - 250 - 330 | 42 - 29 - 14 | 2" | 1156 | 506 | 146 | 2 | 31,4 |
| | | M4T30 | 400 V | 3-phase | | | 5,7 | | | | 1106 | 456 | 146 | | |
| IDROSAND 6/330 | P330/06 | M4M30/2 | 230 V | 1-phase | 3 | 2,2 | 15,7 | 150 - 250 - 330 | 48 - 34 - 16 | 2" | 1192 | 506 | 146 | 2 | 35,4 |
| | | M4T30 | 400 V | 3-phase | | | 5,7 | | | | 1142 | 456 | 146 | | |
| IDROSAND 7/330 | P330/07 | M4T40 | 400 V | 3-phase | 4 | 3 | 8 | 150 - 250 - 330 | 57 - 41 - 20 | 2" | 1253 | 531 | 146 | 2 | 33,9 |
| IDROSAND 9/330 | P330/09 | M4T55 | 400 V | 3-phase | 5,5 | 4 | 10 | 150 - 250 - 330 | 74 - 50 - 24 | 2" | 1381 | 587 | 146 | 2 | 38,8 |
| IDROSAND 10/330 | P330/10 | M4T55 | 400 V | 3-phase | 5,5 | 4 | 10 | 150 - 250 - 330 | 86 - 60 - 29 | 2" | 1417 | 587 | 146 | 2 | 39,2 |
| IDROSAND 12/330 | P330/12 | M6TA75/2 | 400 V | 3-phase | 7,5 | 5,5 | 12,8 | 150 - 250 - 330 | 101 - 69 - 33 | 2" | 1574 | 672 | 146 | 3 | 62 |
| IDROSAND 14/330 | P330/14 | M6TA75/2 | 400 V | 3-phase | 7,5 | 5,5 | 12,8 | 150 - 250 - 330 | 116 - 80 - 37 | 2" | 1646 | 672 | 146 | 3 | 63,1 |
| IDROSAND 16/330 | P330/16 | M6TA10/2 | 400 V | 3-phase | 10 | 7,5 | 17 | 150 - 250 - 330 | 134 - 94 - 46 | 2" | 1743 | 697 | 146 | 3 | 67,2 |
| IDROSAND 19/330 | P330/19 | M6TA10/2 | 400 V | 3-phase | 10 | 7,5 | 17 | 150 - 250 - 330 | 160 - 113 - 56 | 2" | 1851 | 697 | 146 | 3 | 68,5 |
| IDROSAND 23/330 | P330/23 | M6TA125/2 | 400 V | 3-phase | 12,5 | 9,2 | 21,5 | 150 - 250 - 330 | 198 - 143 - 72 | 2" | 2020 | 722 | 146 | 3 | 75,5 |
| IDROSAND 28/330 | P330/28 | M6TA15GH/1 | 400 V | 3-phase | 15 | 11 | 24,8 | 150 - 250 - 330 | 247 - 179 - 93 | 2" | 2295 | 817 | 146 | 3 | 89,2 |
| IDROSAND 32/330 | P330/32 | M6TA20/2 | 400 V | 3-phase | 20 | 15 | 30,7 | 150 - 250 - 330 | 285 - 205 - 108 | 2" | 2551 | 857 | 146 | 3 | 96,9 |
| IDROSAND 36/330 | P330/36 | M6TA20/2 | 400 V | 3-phase | 20 | 15 | 30,7 | 150 - 250 - 330 | 323 - 233 - 123 | 2" | 2695 | 857 | 146 | 3 | 101 |
| IDROSAND 43/330 | P330/43 | M6TA25/2 | 400 V | 3-phase | 25 | 18,5 | 39,6 | 150 - 250 - 330 | 383 - 276 - 145 | 2" | 2987 | 897 | 146 | 3 | 110,6 |

Electric pumps supplied with 4" 'S' series motors up to 4 kW



SUPPLIED WITH

Capacitor (single-phase versions)



OPTIONS FOR 6" MOTORS

Version for star-delta motors 400/690 V

Version with brass motor body

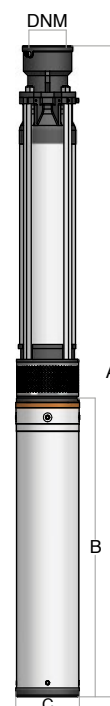

PERFORMANCE CURVES - 2 poles 50 Hz

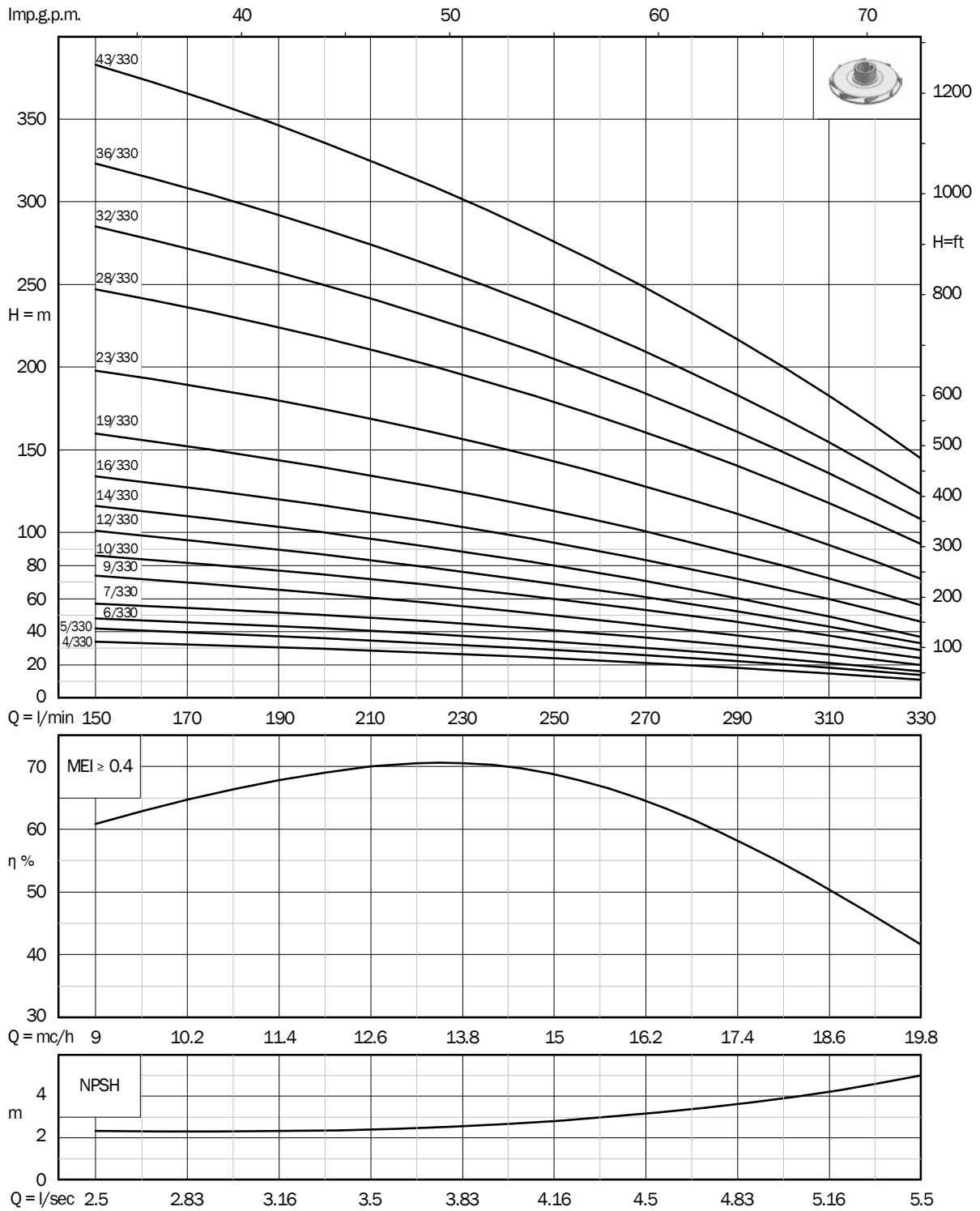

Electric submersible pumps IDROSAND+ series 400

for 6" boreholes

PERFORMANCE DATA - 2 poles 50 Hz

| Radial impeller  | Pump Code | Motor Code | Version | | P2 | | A | Flow | | DNM | Dimensions (mm) | | | Cable m | Weight kg |
|---|-----------|------------|---------|---------|------|------|------|-----------------|-----------------|-----|-----------------|-----|-----|---------|-----------|
| | | | | | hp | kW | | l/min | m | | A | B | C | | |
| IDROSAND+ 4/400 | P400/04 | M4T40 | 400 V | 3-phase | 4 | 3 | 8 | 170 - 300 - 450 | 42 - 31 - 14 | 3" | 1136 | 531 | 146 | 2 | 37 |
| IDROSAND+ 5/400 | P400/05 | M4T55 | 400 V | 3-phase | 5,5 | 4 | 10 | 170 - 300 - 450 | 53 - 42 - 20 | 3" | 1242 | 587 | 146 | 2 | 42,4 |
| IDROSAND+ 6/400 | P400/06 | M4T55 | 400 V | 3-phase | 5,5 | 4 | 10 | 170 - 300 - 450 | 65 - 50 - 25 | 3" | 1292 | 587 | 146 | 2 | 43,8 |
| IDROSAND+ 7/400 | P400/07 | M6TA75/2 | 400 V | 3-phase | 7,5 | 5,5 | 12,8 | 170 - 300 - 450 | 76 - 59 - 29 | 3" | 1427 | 672 | 146 | 3 | 66,5 |
| IDROSAND+ 8/400 | P400/08 | M6TA10/2 | 400 V | 3-phase | 10 | 7,5 | 17 | 170 - 300 - 450 | 88 - 69 - 34 | 3" | 1502 | 697 | 146 | 3 | 71 |
| IDROSAND+ 10/400 | P400/10 | M6TA10/2 | 400 V | 3-phase | 10 | 7,5 | 17 | 170 - 300 - 450 | 110 - 86 - 42 | 3" | 1602 | 697 | 146 | 3 | 74,1 |
| IDROSAND+ 12/400 | P400/12 | M6TA125/2 | 400 V | 3-phase | 12,5 | 9,2 | 21,5 | 170 - 300 - 450 | 130 - 102 - 50 | 3" | 1727 | 722 | 146 | 3 | 80 |
| IDROSAND+ 15/400 | P400/15 | M6TA15GH/1 | 400 V | 3-phase | 15 | 11 | 24,8 | 170 - 300 - 450 | 160 - 126 - 63 | 3" | 1972 | 817 | 146 | 3 | 96,2 |
| IDROSAND+ 20/400 | P400/20 | M6TA20/2 | 400 V | 3-phase | 20 | 15 | 30,7 | 170 - 300 - 450 | 215 - 170 - 84 | 3" | 2262 | 857 | 146 | 3 | 111,3 |
| IDROSAND+ 25/400 | P400/25 | M6TA25/2 | 400 V | 3-phase | 25 | 18,5 | 39,6 | 170 - 300 - 450 | 268 - 210 - 104 | 3" | 2552 | 897 | 146 | 3 | 123,1 |

Electric pumps supplied with 4" 'S' series motors up to 4 kW



OPTIONS FOR 6" MOTORS

Version for star-delta motors 400/690 V

Version with brass motor body



PERFORMANCE CURVES - 2 poles 50 Hz

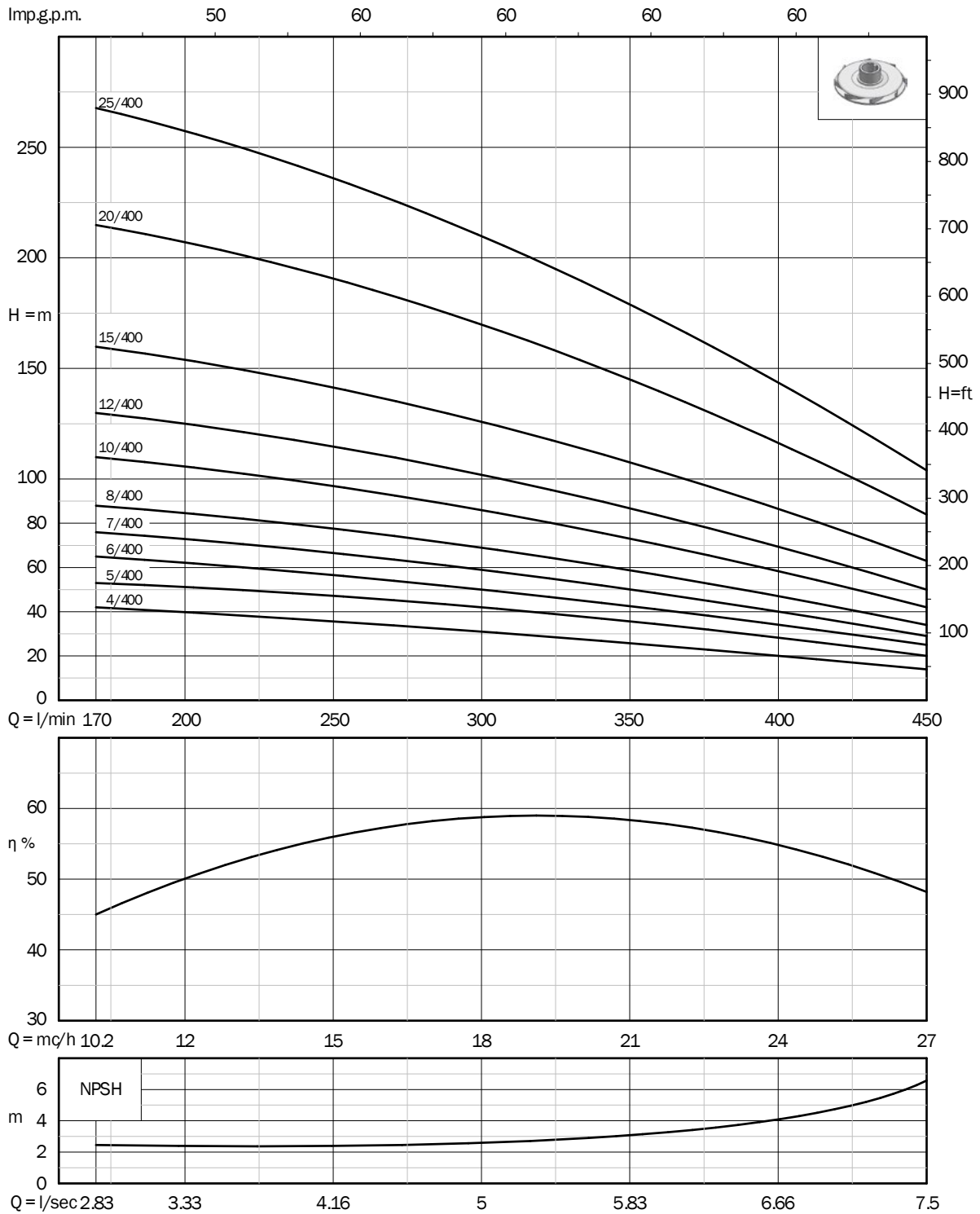

Electric submersible pumps IDROSAND series 530

for 6" boreholes

PERFORMANCE DATA - 2 poles 50 Hz

| Radial impeller  | Pump Code | Motor Code | Version | | P2 | | A | Flow | | DNM | Dimensions (mm) | | | Cable m | Weight kg |
|---|-----------|------------|---------|---------|----------------|---------|------|-----------------|----------------|-----|-----------------|-----|-----|---------|-----------|
| | | | | | hp | kW | | l/min | m | | A | B | C | | |
| | | | | | IDROSAND 4/530 | P530/04 | | M4T40 | 400 V | | 3-phase | 4 | 3 | | |
| IDROSAND 6/530 | P530/06 | M4T55 | 400 V | 3-phase | 5,5 | 4 | 10 | 200 - 330 - 550 | 53 - 48 - 16 | 3" | 1376 | 587 | 146 | 2 | 38,5 |
| IDROSAND 8/530 | P530/08 | M6TA75/2 | 400 V | 3-phase | 7,5 | 5,5 | 12,8 | 200 - 330 - 550 | 70 - 64 - 21 | 3" | 1579 | 672 | 146 | 3 | 61,2 |
| IDROSAND 11/530 | P530/11 | M6TA10/2 | 400 V | 3-phase | 10 | 7,5 | 17 | 200 - 330 - 550 | 97 - 87 - 29 | 3" | 1736 | 697 | 146 | 3 | 66,4 |
| IDROSAND 14/530 | P530/14 | M6TA125/2 | 400 V | 3-phase | 12,5 | 9,2 | 21,5 | 200 - 330 - 550 | 123 - 111 - 37 | 3" | 1911 | 722 | 146 | 3 | 71,3 |
| IDROSAND 17/530 | P530/17 | M6TA15GH/1 | 400 V | 3-phase | 15 | 11 | 24,8 | 200 - 330 - 550 | 149 - 135 - 45 | 3" | 2156 | 817 | 146 | 3 | 85,3 |
| IDROSAND 22/530 | P530/22 | M6TA20/2 | 400 V | 3-phase | 20 | 15 | 30,7 | 200 - 330 - 550 | 193 - 175 - 59 | 3" | 2446 | 857 | 146 | 3 | 94,3 |
| IDROSAND 28/530 | P530/28 | M6TA25/2 | 400 V | 3-phase | 25 | 18,5 | 39,6 | 200 - 330 - 550 | 246 - 223 - 75 | 3" | 2858 | 897 | 146 | 3 | 104,4 |
| IDROSAND 33/530 | P530/33 | M6TA30/2 | 400 V | 3-phase | 30 | 22 | 46 | 200 - 330 - 550 | 290 - 263 - 88 | 3" | 3208 | 997 | 146 | 3 | 119,7 |

Electric pumps supplied with 4" 'S' series motors up to 4 kW



OPTIONS FOR 6" MOTORS

Version for star-delta motors 400/690 V

Version with brass motor body

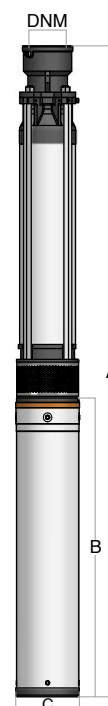

PERFORMANCE CURVES - 2 poles 50 Hz

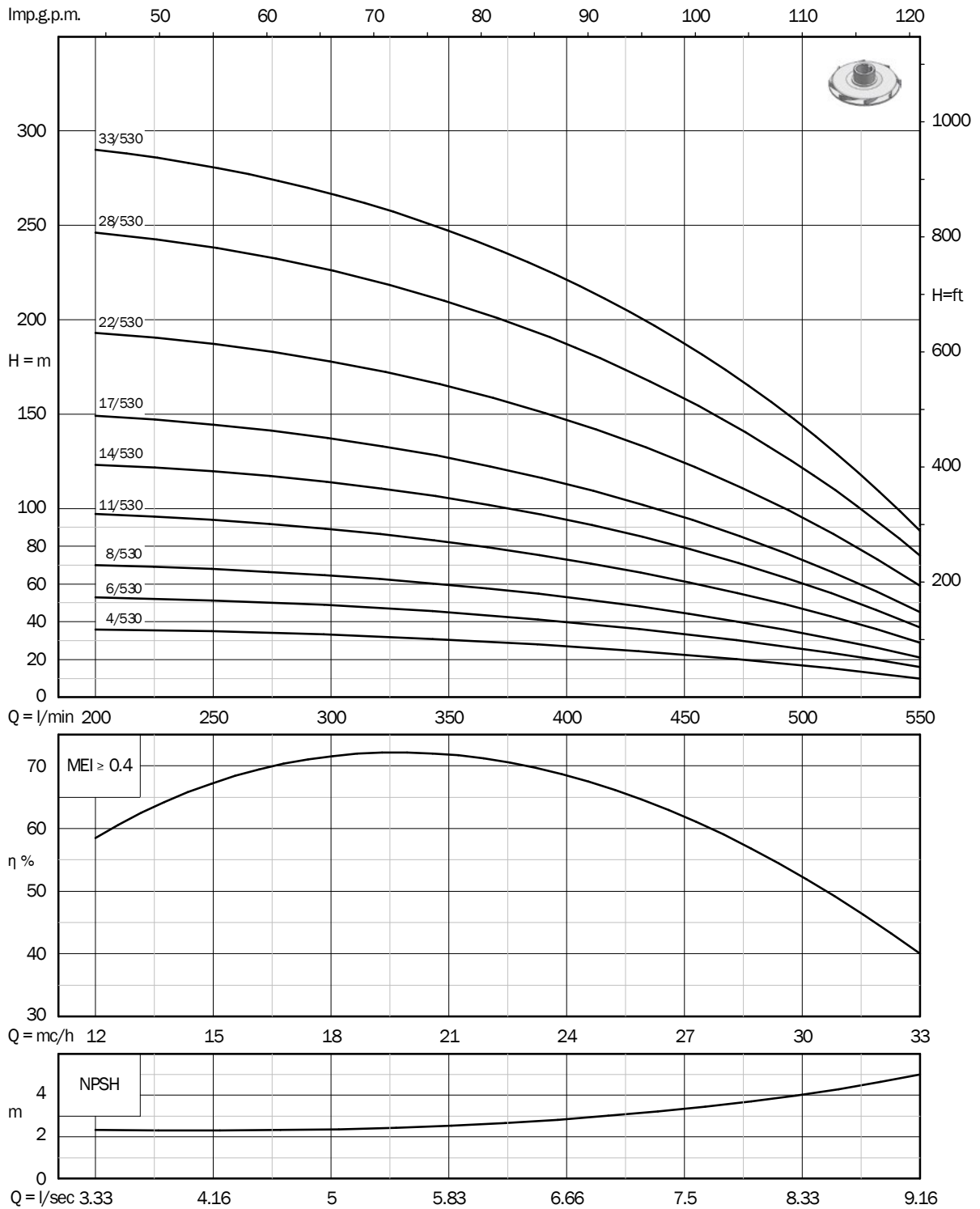

Electric submersible pumps IDROSAND+ series 700

for 6" boreholes

PERFORMANCE DATA - 2 poles 50 Hz

| Semi-axial impeller  | Pump Code | Motor Code | Version | | P2 | | A | Flow | | DNM | Dimensions (mm) | | | Cable m | Weight kg |
|---|-----------|------------|---------|---------|------|------|------|-----------------|----------------|-----|-----------------|-----|-----|---------|-----------|
| | | | | | hp | kW | | l/min | m | | A | B | C | | |
| IDROSAND+ 3/700 | P700/03 | M4T55 | 400 V | 3-phase | 5,5 | 4 | 10 | 350 - 500 - 700 | 34 - 25 - 9 | 3" | 1312 | 587 | 146 | 2 | 38,1 |
| IDROSAND+ 5/700 | P700/05 | M6TA75/2 | 400 V | 3-phase | 7,5 | 5,5 | 12,8 | 350 - 500 - 700 | 56 - 41 - 14 | 3" | 1553 | 672 | 146 | 3 | 61,8 |
| IDROSAND+ 6/700 | P700/06 | M6TA10/2 | 400 V | 3-phase | 10 | 7,5 | 17 | 350 - 500 - 700 | 65 - 48 - 17 | 3" | 1656 | 697 | 146 | 3 | 65,7 |
| IDROSAND+ 8/700 | P700/08 | M6TA125/2 | 400 V | 3-phase | 12,5 | 9,2 | 21,5 | 350 - 500 - 700 | 89 - 69 - 29 | 3" | 1837 | 722 | 146 | 3 | 70,7 |
| IDROSAND+ 10/700 | P700/10 | M6TA15GH/1 | 400 V | 3-phase | 15 | 11 | 24,8 | 350 - 500 - 700 | 112 - 86 - 36 | 3" | 2088 | 817 | 146 | 3 | 84,7 |
| IDROSAND+ 13/700 | P700/13 | M6TA20/2 | 400 V | 3-phase | 20 | 15 | 30,7 | 350 - 500 - 700 | 146 - 111 - 45 | 3" | 2362 | 857 | 146 | 3 | 93,8 |
| IDROSAND+ 16/700 | P700/16 | M6TA25/2 | 400 V | 3-phase | 25 | 18,5 | 39,6 | 350 - 500 - 700 | 177 - 134 - 54 | 3" | 2636 | 897 | 146 | 3 | 101,5 |
| IDROSAND+ 19/700 | P700/19 | M6TA30/2 | 400 V | 3-phase | 30 | 22 | 46 | 350 - 500 - 700 | 210 - 159 - 63 | 3" | 2970 | 997 | 146 | 3 | 115,9 |

Electric pumps supplied with 4" 'S' series motors up to 4 kW



OPTIONS FOR 6" MOTORS

Version for star-delta motors 400/690 V

Version with brass motor body



PERFORMANCE CURVES - 2 poles 50 Hz

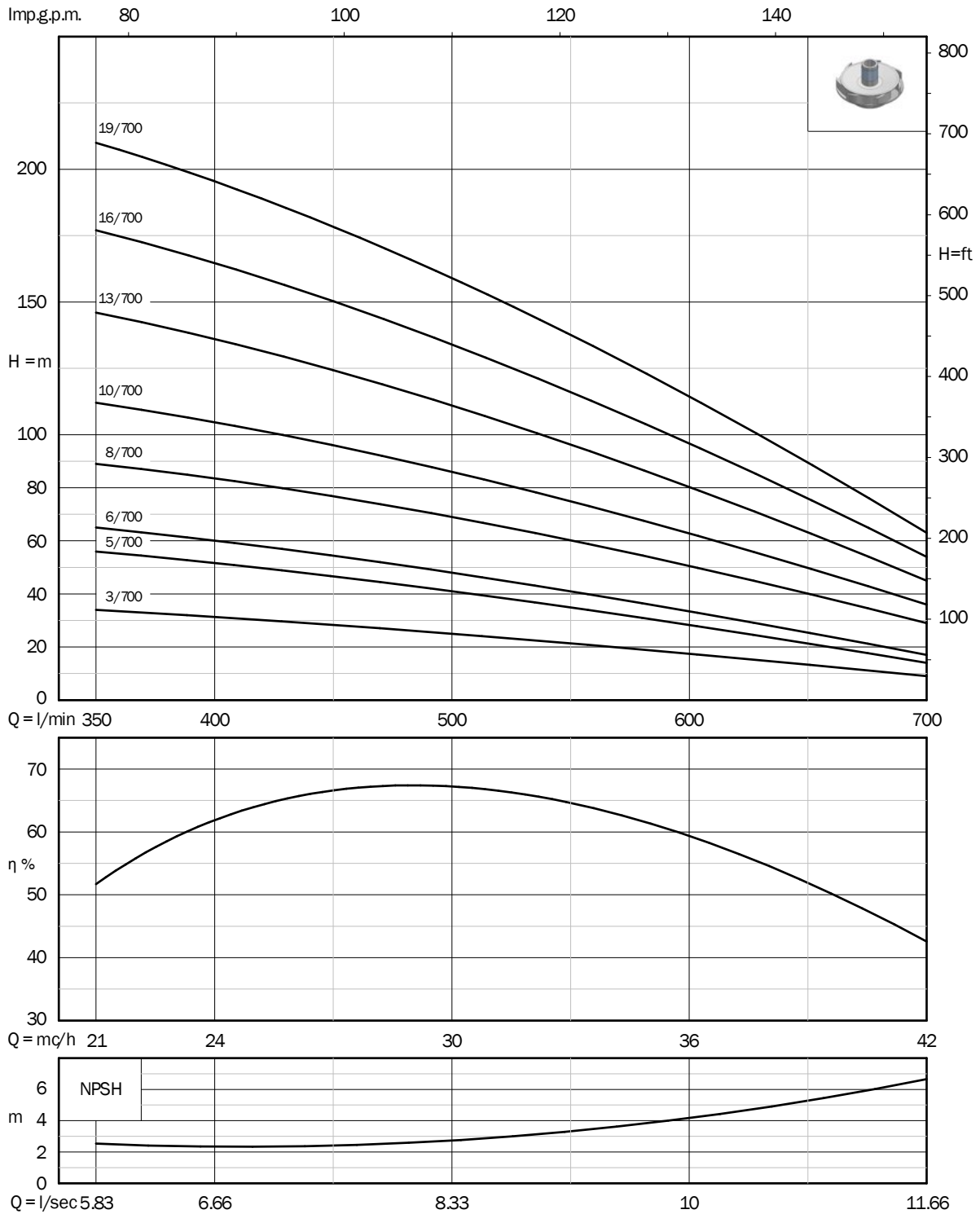

Electric submersible pumps IDROSAND+ series 900

for 6" boreholes

PERFORMANCE DATA - 2 poles 50 Hz

| Semi-axial impeller  | Pump Code | Motor Code | Version | | P2 | | A | Flow | | DNM | Dimensions (mm) | | | Cable m | Weight kg |
|---|-----------|------------|---------|---------|------|------|------|--------------|----------------|-----|-----------------|------|-----|---------|-----------|
| | | | | | hp | kW | | l/min | m | | A | B | C | | |
| IDROSAND+ 2/900 | P900/02 | M4T55 | 400 V | 3-phase | 5,5 | 4 | 10 | 400-650-1000 | 24 - 19 - 9 | 3" | 1298 | 587 | 146 | 2 | 37,2 |
| IDROSAND+ 3/900 | P900/03 | M6TA75/2 | 400 V | 3-phase | 7,5 | 5,5 | 12,8 | 400-650-1000 | 37 - 30 - 13 | 3" | 1491 | 672 | 146 | 3 | 60,3 |
| IDROSAND+ 4/900 | P900/04 | M6TA10/2 | 400 V | 3-phase | 10 | 7,5 | 17 | 400-650-1000 | 50 - 40 - 18 | 3" | 1624 | 697 | 146 | 3 | 64,9 |
| IDROSAND+ 5/900 | P900/05 | M6TA125/2 | 400 V | 3-phase | 12,5 | 9,2 | 21,5 | 400-650-1000 | 63 - 51 - 23 | 3" | 1757 | 722 | 146 | 3 | 69,2 |
| IDROSAND+ 6/900 | P900/06 | M6TA15GH/1 | 400 V | 3-phase | 15 | 11 | 24,8 | 400-650-1000 | 76 - 62 - 29 | 3" | 1960 | 817 | 146 | 3 | 82,5 |
| IDROSAND+ 8/900 | P900/08 | M6TA20/2 | 400 V | 3-phase | 20 | 15 | 30,7 | 400-650-1000 | 101 - 83 - 38 | 3" | 2216 | 857 | 146 | 3 | 91,4 |
| IDROSAND+ 10/900 | P900/10 | M6TA25/2 | 400 V | 3-phase | 25 | 18,5 | 39,6 | 400-650-1000 | 127 - 104 - 48 | 3" | 2472 | 897 | 146 | 3 | 99,3 |
| IDROSAND+ 12/900 | P900/12 | M6TA30/2 | 400 V | 3-phase | 30 | 22 | 46 | 400-650-1000 | 152 - 125 - 58 | 3" | 2788 | 997 | 146 | 3 | 113,8 |
| IDROSAND+ 15/900 | P900/15 | M6TA40/2 | 400 V | 3-phase | 40 | 30 | 62 | 400-650-1000 | 190 - 156 - 74 | 3" | 3242 | 1127 | 146 | 3 | 133,4 |

Electric pumps supplied with 4" 'S' series motors up to 4 kW



OPTIONS FOR 6" MOTORS

Version for star-delta motors 400/690 V

Version with brass motor body



PERFORMANCE CURVES - 2 poles 50 Hz

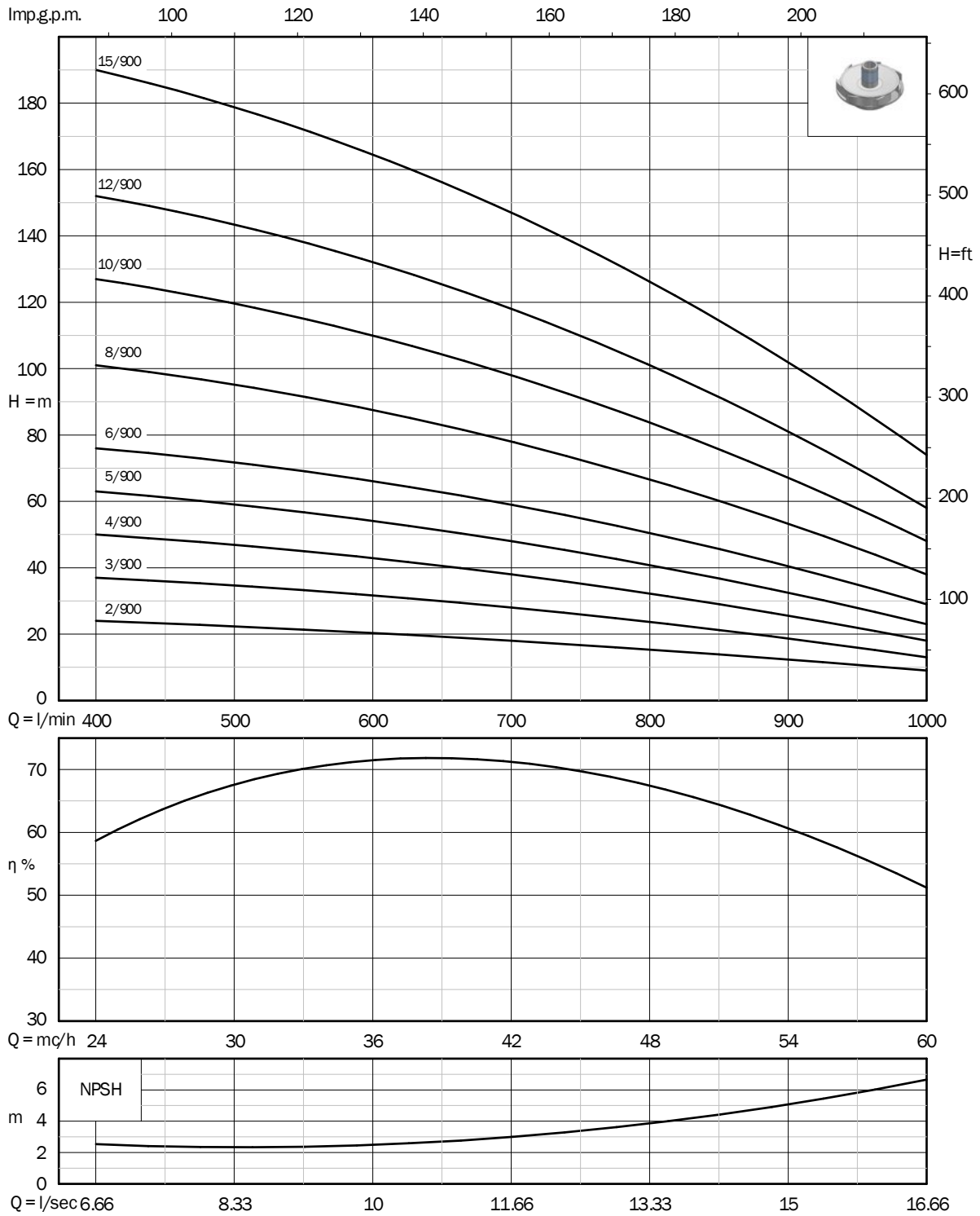

8" (200 mm)



Electric submersible pumps

for 8" boreholes



APPLICATION

To pump water from boreholes

To pressurize civil, agricultural, industrial and fire-fighting plants

Irrigation

CONSTRUCTION

Water filled, asynchronous, rewindable electric AC motor with short circuit rotor. Insulation Class Y

Shafts machined on ball bearings and mechanical seals location

Both shaft and coupling meet NEMA standards

APPLICATION RANGE

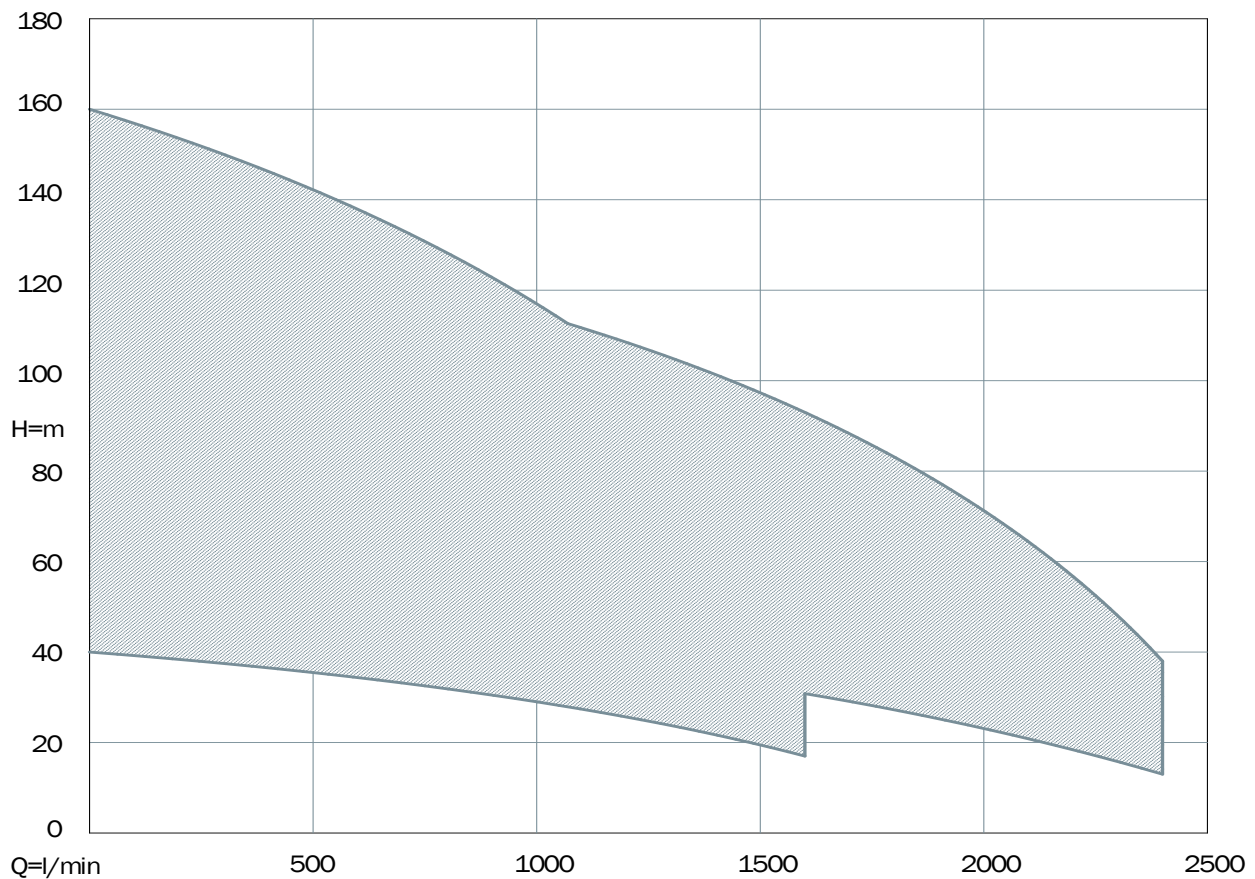

Electric submersible pumps

for 8" boreholes

APPLICATION FEATURES - PUMP END

| | /1600 | /2400 |
|--|--------|-------|
| Minimum depth of the liquid to be pumped (m) | 1,2 | |
| Maximum temperature of the water to be pumped (°C) | 45 | |
| PH of the liquid pumped | 6 - 10 | |
| Maximum sand content (g/m ³) | 50 | |
| Suitable to operate horizontally (included) | All | |



MATERIALS - PUMP END

| | /1600 | /2400 |
|--------------|--|-------|
| Head | Mechanical cast iron EN GJL-200 | |
| Suction Body | Mechanical cast iron EN GJL-200 | |
| Shaft | Stainless steel AISI410 | |
| Coupling | Stainless steel AISI410 | |
| Impellers | Stainless steel AISI410 | |
| Diffusers | Mechanical cast iron EN GJL-200 | |
| Bearings | Antifriction rubber with rotating element in Stainless Steel AISI410 | |
| Check valve | Stainless steel AISI304 | |

APPLICATION FEATURES - MOTOR

| | |
|--|---------------|
| | 6" |
| IP rating | IP68 |
| Duty | Continuous S1 |
| Maximum immersion depth (m) | 200 |
| Maximum number of starts per hour | 20 |
| Maximum temperature of the water pumped (°C) | 30 |
| PH of the liquid pumped | 6 - 10 |
| Suitable for inverter drive | All |
| Suitable to operate horizontally (Included) | All |



MATERIALS - MOTOR

| | |
|-----------------|--|
| | 6" |
| Casing | Stainless Steel AISI304 |
| Shaft Terminal | Stainless Steel AISI420B |
| Upper body | Mechanical cast iron with electrophoresis paint EN GJL-250 or brass OT58 |
| Elastomers | NBR rubber |
| Mechanical seal | Graphite and alumina |
| Foot | ABS |
| Cable | PVC ACS AD8 (for permanent immersion in drinking water) |

Electric submersible pumps

for 8" boreholes

PERFORMANCE DATA - PUMP ENDS - 2 poles 50 Hz

| Semi-axial impeller  | P2 | | DNM | Q | Flow | | | | | | | | | | | | |
|--|--------|----|------|-------------------|----------|-----|-----|------|------|------|------|------|------|------|------|----|--|
| | hp | kW | | m ³ /h | 0 | 30 | 48 | 60 | 72 | 84 | 96 | 108 | 120 | 132 | 144 | | |
| | | | | l/min | 0 | 500 | 800 | 1000 | 1200 | 1400 | 1600 | 1800 | 2000 | 2200 | 2400 | | |
| SERIES 1600 | | | | | | | | | | | | | | | | | |
| 6TA10 | 2/1600 | 10 | 7,5 | 4" | H (m) | 40 | 35 | 32 | 29 | 25 | 21 | 17 | | | | | |
| 6TA15 | 3/1600 | 15 | 11 | 4" | | 60 | 53 | 48 | 44 | 38 | 31 | 25 | | | | | |
| 6TA20 | 4/1600 | 20 | 15 | 4" | | 80 | 70 | 64 | 58 | 51 | 42 | 34 | | | | | |
| 6TA25 | 5/1600 | 25 | 18,5 | 4" | | 100 | 88 | 80 | 73 | 64 | 52 | 42 | | | | | |
| 6TA30 | 6/1600 | 30 | 22 | 4" | | 120 | 105 | 96 | 88 | 76 | 62 | 51 | | | | | |
| 6TA35 | 7/1600 | 35 | 26 | 4" | | 140 | 123 | 112 | 102 | 89 | 73 | 59 | | | | | |
| 6TA40 | 8/1600 | 40 | 30 | 4" | | 160 | 140 | 128 | 117 | 102 | 83 | 67 | | | | | |
| SERIES 2400 | | | | | | | | | | | | | | | | | |
| 6TA15 | 2/2400 | 15 | 11 | 5" | H (m) | 45 | | | 39 | 37 | 34 | 31 | 27 | 22 | 18 | 13 | |
| 6TA25 | 3/2400 | 25 | 18,5 | 5" | | 68 | | | 58 | 56 | 52 | 47 | 40 | 33 | 26 | 19 | |
| 6TA30 | 4/2400 | 30 | 22 | 5" | | 90 | | | 78 | 74 | 69 | 62 | 53 | 44 | 35 | 26 | |
| 6TA40 | 5/2400 | 40 | 30 | 5" | | 113 | | | 97 | 93 | 86 | 78 | 67 | 55 | 44 | 32 | |
| 6TA50 | 6/2400 | 50 | 37 | 5" | | 135 | | | 116 | 111 | 103 | 93 | 80 | 66 | 52 | 38 | |

PERFORMANCE DATA - MOTORS - 2 poles 50 Hz

| Type | Code | Voltage | Number of phases | P2 | | Axial load | Rotation | Nominal current | Start current | Start Torque | Efficiency % | Power factor | Size of cable | Length of cable |
|---|-------------|---------|------------------|-------------------|------|------------|----------|-----------------|---------------|--------------|--------------|--------------|---------------|-----------------|
| | | | | hp | kW | F | η_N | I_N | I_A | M_A | η_N | cos ϕ | | |
| | | V | N | min ⁻¹ | A | A | Nm | mm ² | m | | | | | |
| WATER FILLED SUBMERSIBLE MOTORS for 6" boreholes | | | | | | | | | | | | | | |
| 6TA55 | M6TA55/2 | 400 | 3 | 5,5 | 4 | 8000 | 2900 | 10,6 | 55 | 34 | 81 | 0,7 | 4 x 4 | 3 |
| 6TA75 | M6TA75/2 | 400 | 3 | 7,5 | 5,5 | 8000 | 2840 | 12,8 | 55 | 34 | 81 | 0,77 | 4 x 4 | 3 |
| 6TA10 | M6TA10/2 | 400 | 3 | 10 | 7,5 | 8000 | 2830 | 17 | 73 | 51 | 80 | 0,79 | 4 x 4 | 3 |
| 6TA125 | M6TA125/2 | 400 | 3 | 12,5 | 9,2 | 8000 | 2830 | 21,5 | 90 | 69 | 80 | 0,78 | 4 x 4 | 3 |
| 6TA15 | M6TA15GH/1 | 400 | 3 | 15 | 11 | 8000 | 2850 | 24,8 | 110 | 80 | 81 | 0,79 | 4 x 4 | 3 |
| 6TAH15 | M6TA15HGH/1 | 400 | 3 | 15 | 11 | 18000 | 2850 | 24,8 | 110 | 80 | 81 | 0,79 | 4 x 4 | 3 |
| 6TA20 | M6TA20/2 | 400 | 3 | 20 | 15 | 18000 | 2880 | 30,7 | 140 | 63 | 85 | 0,8 | 4 x 4 | 3 |
| 6TA25 | M6TA25/2 | 400 | 3 | 25 | 18,5 | 18000 | 2870 | 39,6 | 160 | 74 | 85 | 0,8 | 4 x 6 | 3 |
| 6TA30 | M6TA30/2 | 400 | 3 | 30 | 22 | 18000 | 2900 | 46 | 180 | 97 | 86 | 0,8 | 4 x 6 | 3 |
| 6TA35 | M6TA35/2 | 400 | 3 | 35 | 26 | 18000 | 2910 | 55,5 | 270 | 130 | 88 | 0,76 | 4 x 6 | 3 |
| 6TA40 | M6TA40/2 | 400 | 3 | 40 | 30 | 18000 | 2900 | 62 | 270 | 130 | 87 | 0,8 | 4 x 6 | 3 |
| 6TA50 | M6TA50/2 | 400 | 3 | 50 | 37 | 18000 | 2900 | 81,8 | 360 | 155 | 87 | 0,8 | 4 x 6 | 3 |

Electric submersible pumps series 1600

for 8" boreholes

PERFORMANCE DATA - 2 poles 50 Hz

| Semi-axial impeller  | Pump Code | Motor Code | Version | | P2 | | A | Flow | | DNM | Dimensions (mm) | | | Cable m | Weight kg |
|---|-----------|------------|---------|---------|----|------|------|-------------------|----------------|-----|-----------------|------|-----|------------|--------------|
| | | | | | hp | kW | | l/min | m | | A | B | C | | |
| 6TA10 2/1600 | P1600/02 | M6TA10/2 | 400 V | 3-phase | 10 | 7,5 | 17 | 500 - 1000 - 1600 | 35 - 29 - 17 | 4" | 1357 | 697 | 196 | 3 | 82,9 |
| 6TA15 3/1600 | P1600/03 | M6TA15GH/1 | 400 V | 3-phase | 15 | 11 | 24,8 | 500 - 1000 - 1600 | 53 - 44 - 25 | 4" | 1607 | 817 | 196 | 3 | 107,4 |
| 6TA20 4/1600 | P1600/04 | M6TA20/2 | 400 V | 3-phase | 20 | 15 | 30,7 | 500 - 1000 - 1600 | 70 - 58 - 34 | 4" | 1777 | 857 | 196 | 3 | 122,2 |
| 6TA25 5/1600 | P1600/05 | M6TA25/2 | 400 V | 3-phase | 25 | 18,5 | 39,6 | 500 - 1000 - 1600 | 88 - 73 - 42 | 4" | 1947 | 897 | 196 | 3 | 136,9 |
| 6TA30 6/1600 | P1600/06 | M6TA30/2 | 400 V | 3-phase | 30 | 22 | 46 | 500 - 1000 - 1600 | 105 - 88 - 51 | 4" | 2177 | 997 | 196 | 3 | 158,1 |
| 6TA35 7/1600 | P1600/07 | M6TA35/2 | 400 V | 3-phase | 35 | 26 | 55,5 | 500 - 1000 - 1600 | 123 - 102 - 59 | 4" | 2437 | 1127 | 196 | 3 | 182,6 |
| 6TA40 8/1600 | P1600/08 | M6TA40/2 | 400 V | 3-phase | 40 | 30 | 62 | 500 - 1000 - 1600 | 140 - 117 - 67 | 4" | 2567 | 1127 | 196 | 3 | 193 |

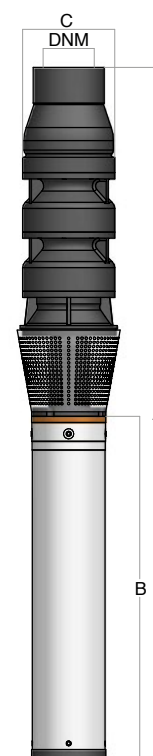

OPTIONS

Version for star-delta motors 400/690 V

Version with brass motor body

PERFORMANCE CURVES - 2 poles 50 Hz

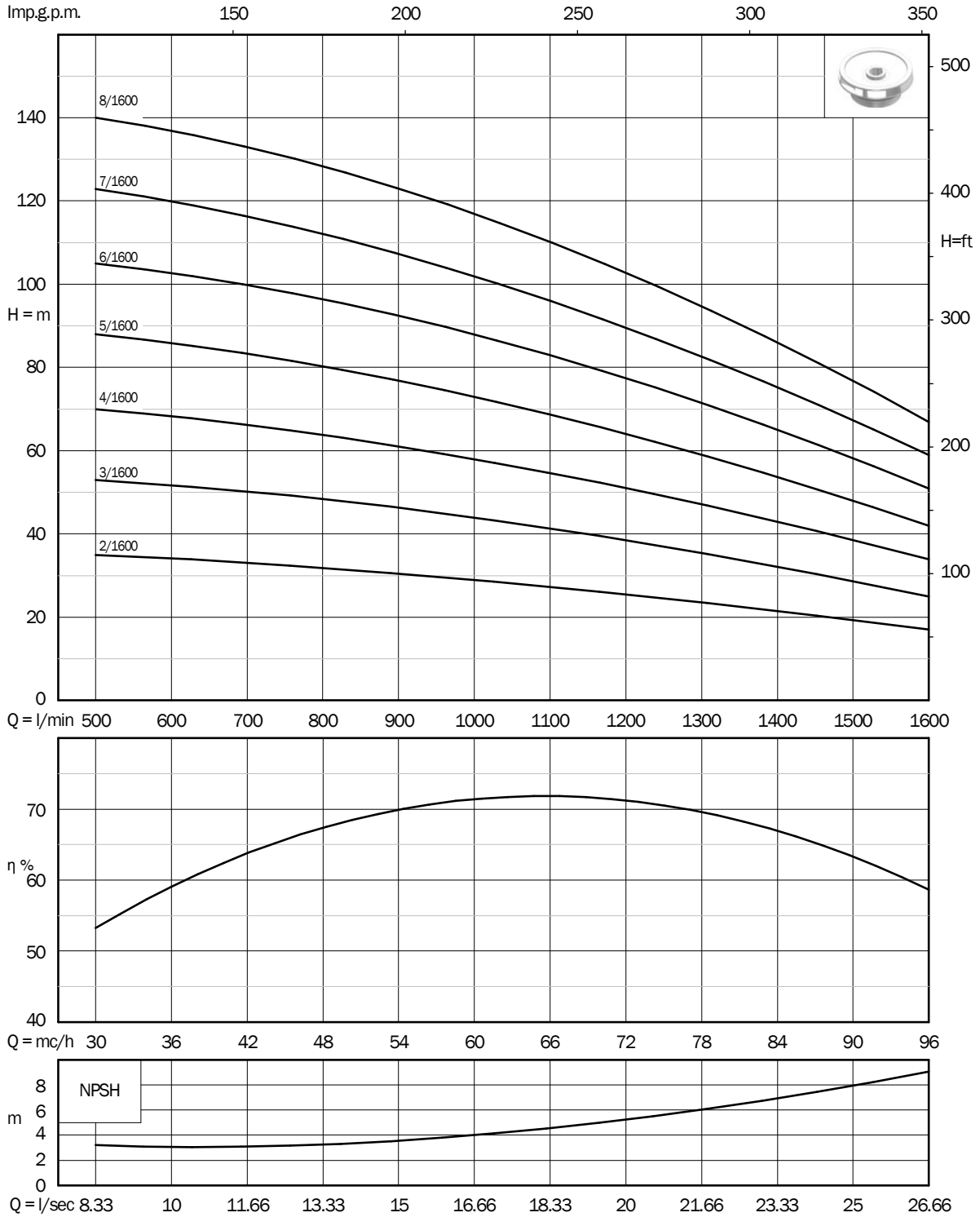

Electric submersible pumps series 2400

for 8" boreholes

PERFORMANCE DATA - 2 poles 50 Hz

| Semi-axial impeller  | Pump Code | Motor Code | Version | | P2 | | A | Flow | | DNM | Dimensions (mm) | | | Cable m | Weight kg |
|---|-----------|------------|---------|---------|----|------|------|----------------|-----------|-----|-----------------|------|-----|------------|--------------|
| | | | | | hp | kW | | l/min | m | | A | B | C | | |
| 6TA15 2/2400 | P2400/02 | M6TA15GH/1 | 400 V | 3-phase | 15 | 11 | 24,8 | 1000-1600-2400 | 39-31-13 | 5" | 1480 | 817 | 196 | 3 | 98,7 |
| 6TA25 3/2400 | P2400/03 | M6TA25/2 | 400 V | 3-phase | 25 | 18,5 | 39,6 | 1000-1600-2400 | 58-47-19 | 5" | 1690 | 897 | 196 | 3 | 117,7 |
| 6TA30 4/2400 | P2400/04 | M6TA30/2 | 400 V | 3-phase | 30 | 22 | 46 | 1000-1600-2400 | 78-62-26 | 5" | 1920 | 997 | 196 | 3 | 138,9 |
| 6TA40 5/2400 | P2400/05 | M6TA40/2 | 400 V | 3-phase | 40 | 30 | 62 | 1000-1600-2400 | 97-78-32 | 5" | 2180 | 1127 | 196 | 3 | 163,3 |
| 6TA50 6/2400 | P2400/06 | M6TA50/2 | 400 V | 3-phase | 50 | 37 | 81,8 | 1000-1600-2400 | 116-93-38 | 5" | 2450 | 1267 | 196 | 3 | 188,7 |

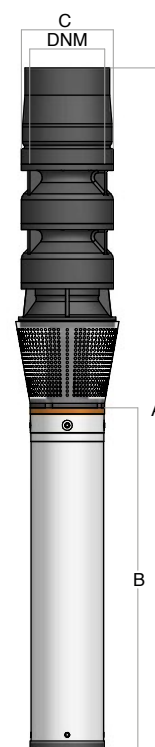

OPTIONS

Version for star-delta motors 400/690 V

Version with brass motor body

PERFORMANCE CURVES - 2 poles 50 Hz

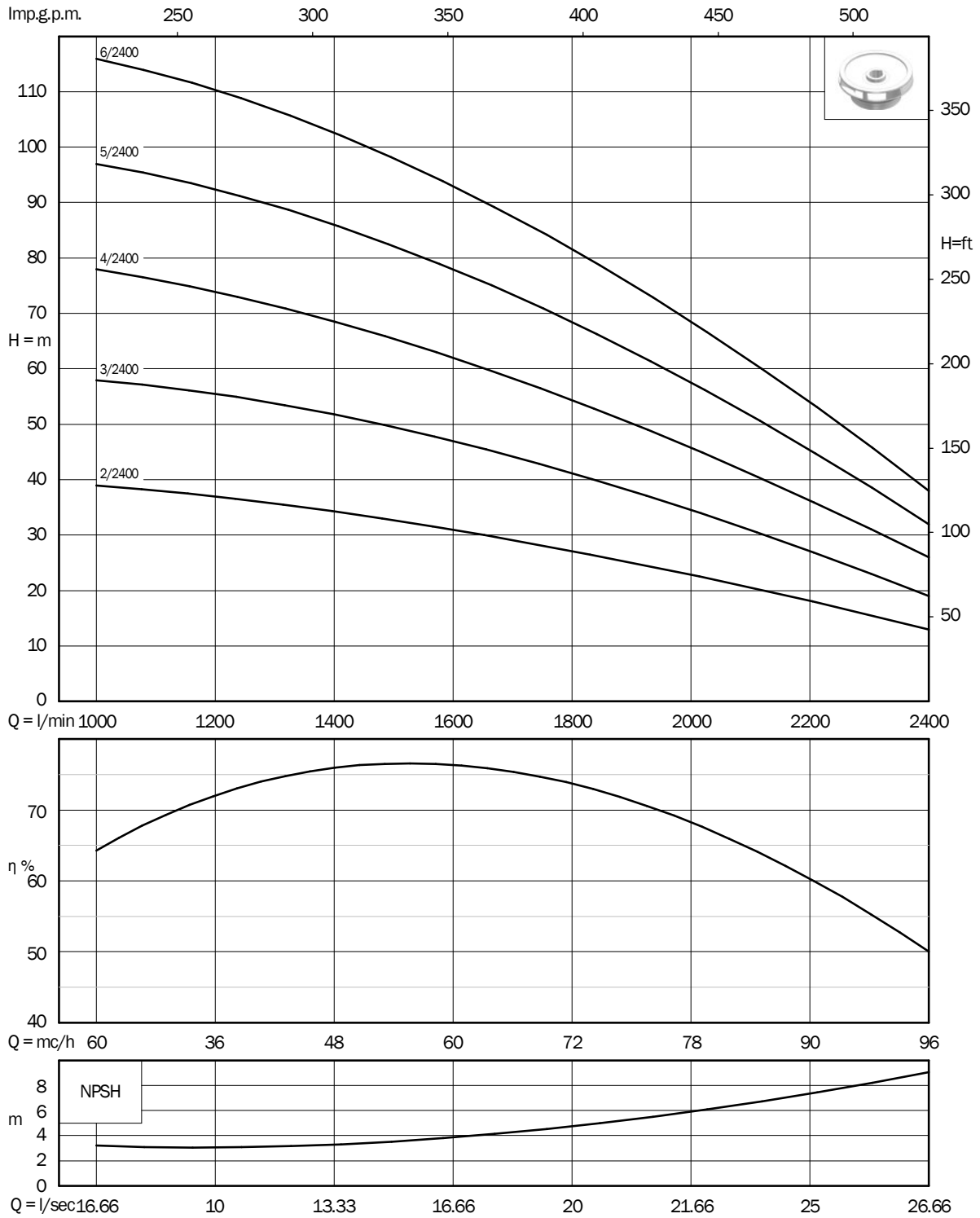

CMO



External electric pumps CMO

horizontal multistage



APPLICATION

To pump water from reservoirs or tanks

To pressurize civil plants

Irrigation

To feed boilers

CHARACTERISTICS

| | |
|---|---------------|
| IP rating | IP55 |
| Duty | Continuous S1 |
| Maximum number of starts per hour | 20 |
| Maximum temperature of the liquid pumped (°C) | 40 |
| PH of the liquid pumped | 6 - 10 |

APPLICATION RANGE

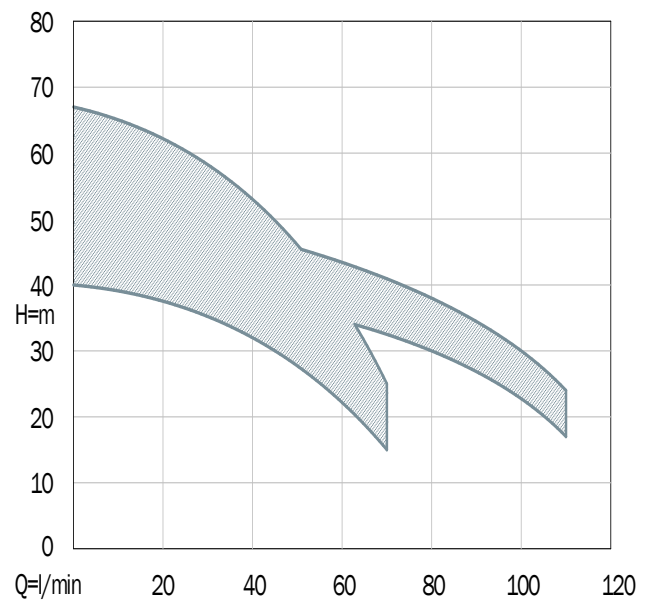

CONSTRUCTION

Coolant filled, asynchronous, rewindable electric AC motor with short circuit rotor. Insulation Class F

External ventilation

Self priming pumps; they can prime water even when the liquid pumped is mixed with air

MATERIALS

| | |
|---------------------------------------|-------------------------------------|
| Suction body and discharge | Mechanical cast iron EN GJL-200 |
| Pump casing, tie-rods, bolts and nuts | Stainless Steel AISI304 |
| Shaft | Stainless Steel AISI420 |
| Impellers | Stainless Steel AISI304 |
| Diffusers | Polymer reinforced with fibre-glass |
| Mechanical seal | Graphite and ceramics |

External electric pumps CMO

horizontal multistage

PERFORMANCE DATA - 2 poles 50 Hz

| Radial impeller  | Code | Version | P2 | | A | µF | DNM | Q m³/h l/min | Flow | | | | | | | Dimensions (mm) | | | | Weight kg | |
|---|------------|---------|---------|------|------|------|-----|--------------------|-------|----|----|----|----|----|-----|-----------------|-----|-----|-----|--------------|-------|
| | | | hp | kW | | | | | 0 | 20 | 30 | 50 | 70 | 90 | 110 | A | B | C | D | | |
| | | | | | | | | | | | | | | | | | | | | | H (m) |
| SERIES 70 | | | | | | | | | | | | | | | | | | | | | |
| CMO 3/70 | EM70/030/1 | 230 V | 1-phase | 0,75 | 0,55 | 3,44 | 16 | 1"¼ | H (m) | 40 | 37 | 35 | 27 | 15 | | | 398 | 163 | 219 | 186 | 13 |
| CMO 4/70 | EM70/040/1 | 230 V | 1-phase | 1 | 0,75 | 4,78 | 20 | 1"¼ | | 54 | 49 | 47 | 36 | 20 | | | 419 | 184 | 240 | 186 | 14,2 |
| CMO 5/70 | EM70/050/1 | 230 V | 1-phase | 1,25 | 0,92 | 6,12 | 25 | 1"¼ | | 67 | 62 | 58 | 45 | 25 | | | 440 | 205 | 261 | 187 | 15,2 |
| SERIES 110 | | | | | | | | | | | | | | | | | | | | | |
| CMO 4/110 | EM110/040 | 230 V | 1-phase | 1,25 | 0,92 | 6,12 | 25 | 1" | H (m) | 41 | | 39 | 37 | 33 | 26 | 17 | 458 | 228 | 279 | 186 | 15,1 |
| CMO 5/110 | EM110/050 | 230 V | 1-phase | 1,5 | 1,1 | 7,08 | 25 | 1" | | 53 | | 51 | 47 | 41 | 34 | 24 | 527 | 276 | 328 | 197 | 17 |

SUPPLIED WITH

Capacitor

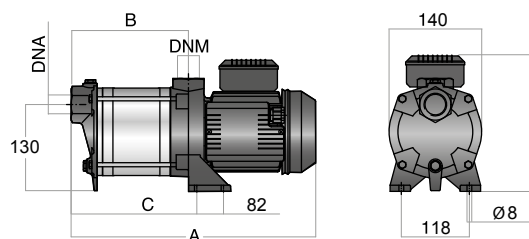

PERFORMANCE CURVES - 2 poles 50 Hz

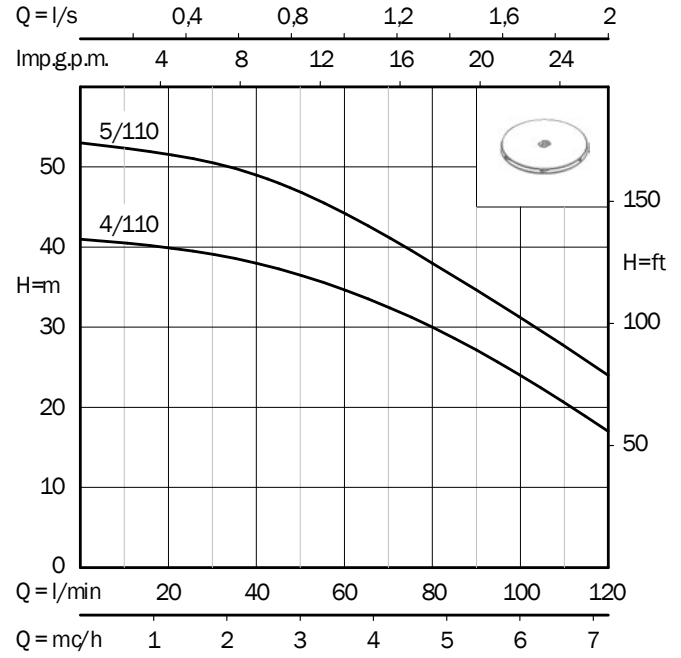
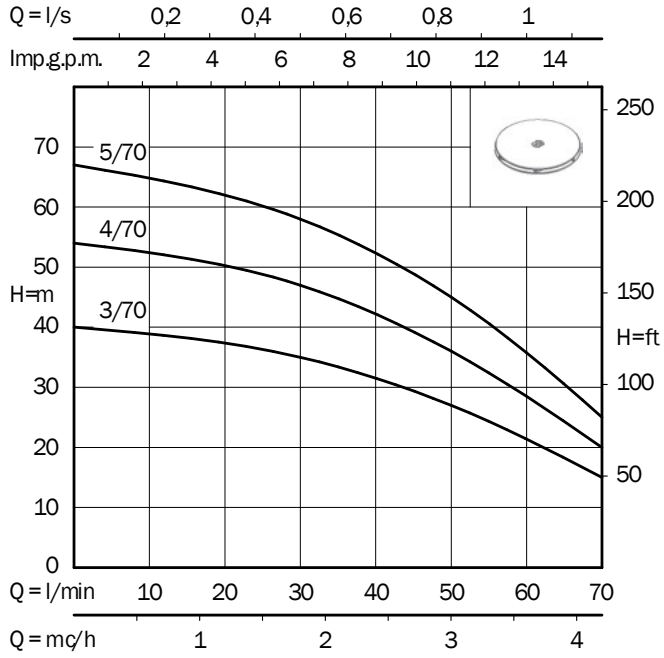

CV



External electric pumps CV

vertical multistage



APPLICATION

To pump water from reservoirs or tanks

To pressurize civil, agricultural and industrial plants

Irrigation

To feed boilers

To convey water for heating, cooling and conditioning plants

CHARACTERISTICS

| | |
|---|---------------------------|
| IP rating | IP54 |
| Duty | Continuous S1 |
| Maximum number of starts per hour | 20 |
| Maximum temperature of the liquid pumped (°C) | 80 |
| PH of the liquid pumped | 6 - 10 |
| Suitable for inverter drive | Three-phase versions only |

APPLICATION RANGE

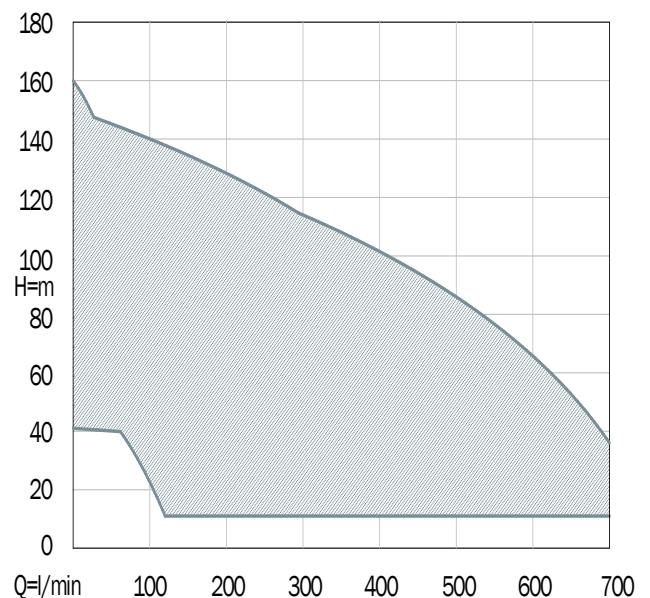

CONSTRUCTION

Coolant filled, asynchronous, rewindable electric AC motor with short circuit rotor. Insulation Class F

400 V Motors in efficiency class IE3

External ventilation

MATERIALS

| | |
|---------------------------------------|---|
| Suction body and discharge | Mechanical Cast iron EN GJL-200 |
| Pump casing, tie rods, bolts and nuts | Stainless Steel AISI304 |
| Shaft | Stainless Steel AISI420B |
| Impellers and diffusers | Noryl® reinforced with fibre-glass, certified for drinking water and AISI304 stainless steel wear rings |
| Coupling | Mechanical Cast iron EN GJL-200 |
| Guide ball bearing | Self-lubricating bronze |
| Mechanical seal | Graphite and Alumina |
| Diffuser bush | Anti fiction rubber (series 700) |



External electric pumps CV

vertical multistage

PERFORMANCE DATA - 2 poles 50 Hz

| Radial impeller  | P2 | | 1~230 V | | 3~400 V | DNA | Q | Flow | | | | | | | | | | | | | | | | | | |
|---|-----|------|---------|----|---------|-----|----------|------|-------------------|-----|-----|-----|-----|-----|-----|-----|-----|-----|------|------|------|------|-----|------|--|--|
| | hp | kW | A | µF | A | | | DNM | m ³ /h | 0 | 1,8 | 2,4 | 3 | 4,2 | 6 | 7,2 | 8,4 | 9,6 | 11,4 | 12,6 | 13,8 | 15,6 | 18 | 19,8 | | |
| | | | | | | | | | l/min | 0 | 30 | 40 | 50 | 70 | 100 | 120 | 140 | 160 | 190 | 210 | 230 | 260 | 300 | 330 | | |
| SERIES 110 | | | | | | | | | | | | | | | | | | | | | | | | | | |
| CV 6/110 | 1 | 0,75 | 5,2 | 20 | 1,8 | 1"½ | H (m) | 54 | 50 | 47 | 44 | 37 | 23 | 11 | | | | | | | | | | | | |
| CV 9/110 | 1,5 | 1,1 | 7,6 | 30 | 2,9 | 1"½ | | 80 | 72 | 69 | 65 | 55 | 33 | 16 | | | | | | | | | | | | |
| CV 12/110 | 2 | 1,5 | 10,9 | 45 | 3,3 | 1"½ | | 105 | 95 | 91 | 85 | 71 | 44 | 21 | | | | | | | | | | | | |
| CV 18/110 | 3 | 2,2 | 14,5 | 60 | 4,65 | 1"½ | | 160 | 148 | 140 | 131 | 109 | 67 | 31 | | | | | | | | | | | | |
| SERIES 230 | | | | | | | | | | | | | | | | | | | | | | | | | | |
| CV 5/230 | 1,5 | 1,1 | 7,6 | 30 | 2,9 | 1"½ | H (m) | 47 | | | 46 | 44 | 41 | 39 | 36 | 32 | 25 | 20 | 13 | | | | | | | |
| CV 6/230 | 2 | 1,5 | 10,9 | 45 | 3,3 | 1"½ | | 56 | | | 55 | 53 | 50 | 46 | 42 | 37 | 29 | 22 | 15 | | | | | | | |
| CV 8/230 | 3 | 2,2 | 14,5 | 60 | 4,65 | 1"½ | | 75 | | | 73 | 70 | 65 | 60 | 55 | 49 | 38 | 29 | 20 | | | | | | | |
| CV 11/230 | 4 | 3 | | | 6 | 1"½ | | 103 | | | 100 | 97 | 91 | 85 | 78 | 70 | 56 | 46 | 33 | | | | | | | |
| CV 14/230 | 5,5 | 4 | | | 8,4 | 1"½ | | 138 | | | 134 | 130 | 122 | 115 | 104 | 93 | 74 | 59 | 43 | | | | | | | |
| SERIES 330 | | | | | | | | | | | | | | | | | | | | | | | | | | |
| CV 5/330 | 3 | 2,2 | 14,5 | 60 | 4,65 | 1"½ | H (m) | 49 | | | | | 46 | 45 | 43 | 41 | 38 | 35 | 32 | 27 | 20 | 14 | | | | |
| CV 7/330 | 4 | 3 | | | 6 | 1"½ | | 68 | | | | | 61 | 59 | 57 | 55 | 52 | 49 | 45 | 39 | 29 | 20 | | | | |
| CV 10/330 | 5,5 | 4 | | | 8,4 | 1"½ | | 102 | | | | | 94 | 91 | 88 | 84 | 77 | 72 | 66 | 57 | 42 | 29 | | | | |
| CV 14/330 | 7,5 | 5,5 | | | 10,1 | 1"½ | | 138 | | | | | 128 | 124 | 120 | 114 | 103 | 98 | 88 | 75 | 54 | 37 | | | | |

PERFORMANCE DATA - 2 poles 50 Hz

| Radial impeller  | P2 | | 3~400 V | | DNA | DNM | Q | Flow | | | | | | | | | | | | | |
|---|------|-----|---------|-----|-----|----------|-----|-------------------|-----|-----|-----|------|-----|------|------|-----|-----|-----|-----|-----|-----|
| | hp | kW | A | | | | | m ³ /h | 0 | 12 | 15 | 16,8 | 18 | 19,8 | 21,6 | 24 | 27 | 30 | 33 | 36 | 39 |
| | | | | | | | | l/min | 0 | 200 | 250 | 280 | 300 | 330 | 360 | 400 | 450 | 500 | 550 | 600 | 650 |
| SERIES 530 | | | | | | | | | | | | | | | | | | | | | |
| CV 4/530 | 4 | 3 | 6 | 2"½ | 2" | H (m) | 43 | 36 | 35 | 34 | 33 | 32 | 30 | 27 | 22 | 16 | 10 | | | | |
| CV 6/530 | 5,5 | 4 | 8,4 | 2"½ | 2" | | 64 | 53 | 52 | 50 | 49 | 48 | 45 | 40 | 33 | 24 | 16 | | | | |
| CV 8/530 | 7,5 | 5,5 | 10,1 | 2"½ | 2" | | 86 | 70 | 68 | 66 | 65 | 64 | 61 | 53 | 43 | 33 | 21 | | | | |
| CV 11/530 | 10 | 7,5 | 14,3 | 2"½ | 2" | | 118 | 97 | 94 | 92 | 90 | 87 | 83 | 73 | 60 | 44 | 29 | | | | |
| CV 14/530 | 12,5 | 9,2 | 17,7 | 2"½ | 2" | | 150 | 123 | 119 | 116 | 114 | 111 | 106 | 94 | 76 | 56 | 37 | | | | |
| Semi-axial impeller  | P2 | | 3~400 V | | DNA | DNM | Q | Flow | | | | | | | | | | | | | |
| | hp | kW | A | | | | | m ³ /h | 0 | 12 | 15 | 16,8 | 18 | 19,8 | 21,6 | 24 | 27 | 30 | 33 | 36 | 39 |
| | | | | | | | | l/min | 0 | 200 | 250 | 280 | 300 | 330 | 360 | 400 | 450 | 500 | 550 | 600 | 650 |
| SERIES 700 | | | | | | | | | | | | | | | | | | | | | |
| CV 3/700 | 5,5 | 4 | 8,4 | 2"½ | 2" | H (m) | 41 | | | | 35 | 34 | 33 | 31 | 28 | 25 | 22 | 18 | 14 | 9 | |
| CV 5/700 | 7,5 | 5,5 | 10,1 | 2"½ | 2" | | 68 | | | | 59 | 57 | 55 | 51 | 46 | 41 | 35 | 28 | 21 | 14 | |
| CV 6/700 | 10 | 7,5 | 14,3 | 2"½ | 2" | | 84 | | | | 68 | 66 | 63 | 59 | 54 | 48 | 42 | 34 | 27 | 17 | |
| CV 8/700 | 12,5 | 9,2 | 17,7 | 2"½ | 2" | | 113 | | | | 93 | 91 | 87 | 83 | 76 | 69 | 60 | 50 | 40 | 29 | |
| CV 10/700 | 15 | 11 | 19,4 | 2"½ | 2" | | 141 | | | | 116 | 114 | 110 | 104 | 96 | 86 | 75 | 62 | 50 | 36 | |

External electric pumps CV series 110

vertical multistage

PERFORMANCE DATA - 2 poles 50 Hz

| Radial impeller  | Code | Version | | P2 | | A | Flow | | DNA | Dimensions (mm) | | | | Weight kg |
|---|------------|---------|---------|-----|------|------|---------------|----------------|-----|-----------------|-----|-----|----|--------------|
| | | | | hp | kW | | l/min | m | | DNM | A | B | C | |
| CV 6/110 | EM110/06 | 230 V | 1-phase | 1 | 0,75 | 5,2 | 30 - 70 - 120 | 50 - 37 - 11 | 1"½ | 662 | 286 | 180 | 51 | 22,2 |
| | ET110/06/2 | 400 V | 3-phase | | | 1,8 | | | | 667 | | | | 22,7 |
| CV 9/110 | EM110/09 | 230 V | 1-phase | 1,5 | 1,1 | 7,6 | 30 - 70 - 120 | 72 - 55 - 16 | 1"½ | 752 | 376 | 180 | 51 | 25,8 |
| | ET110/09/2 | 400 V | 3-phase | | | 2,9 | | | | 757 | | | | 24,8 |
| CV 12/110 | EM110/12 | 230 V | 1-phase | 2 | 1,5 | 10,9 | 30 - 70 - 120 | 95 - 71 - 21 | 1"½ | 847 | 466 | 180 | 51 | 28,3 |
| | ET110/12/2 | 400 V | 3-phase | | | 3,3 | | | | 847 | | | | 28,8 |
| CV 18/110 | EM110/18 | 230 V | 1-phase | 3 | 2,2 | 14,5 | 30 - 70 - 120 | 148 - 109 - 31 | 1"½ | 1093 | 646 | 180 | 51 | 35 |
| | ET110/18/2 | 400 V | 3-phase | | | 4,65 | | | | 1074 | | | | 35 |



SUPPLIED WITH

Capacitor (single-phase versions)

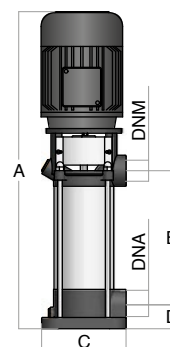
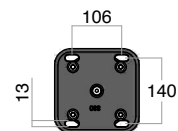

PERFORMANCE CURVES - 2 poles 50 Hz

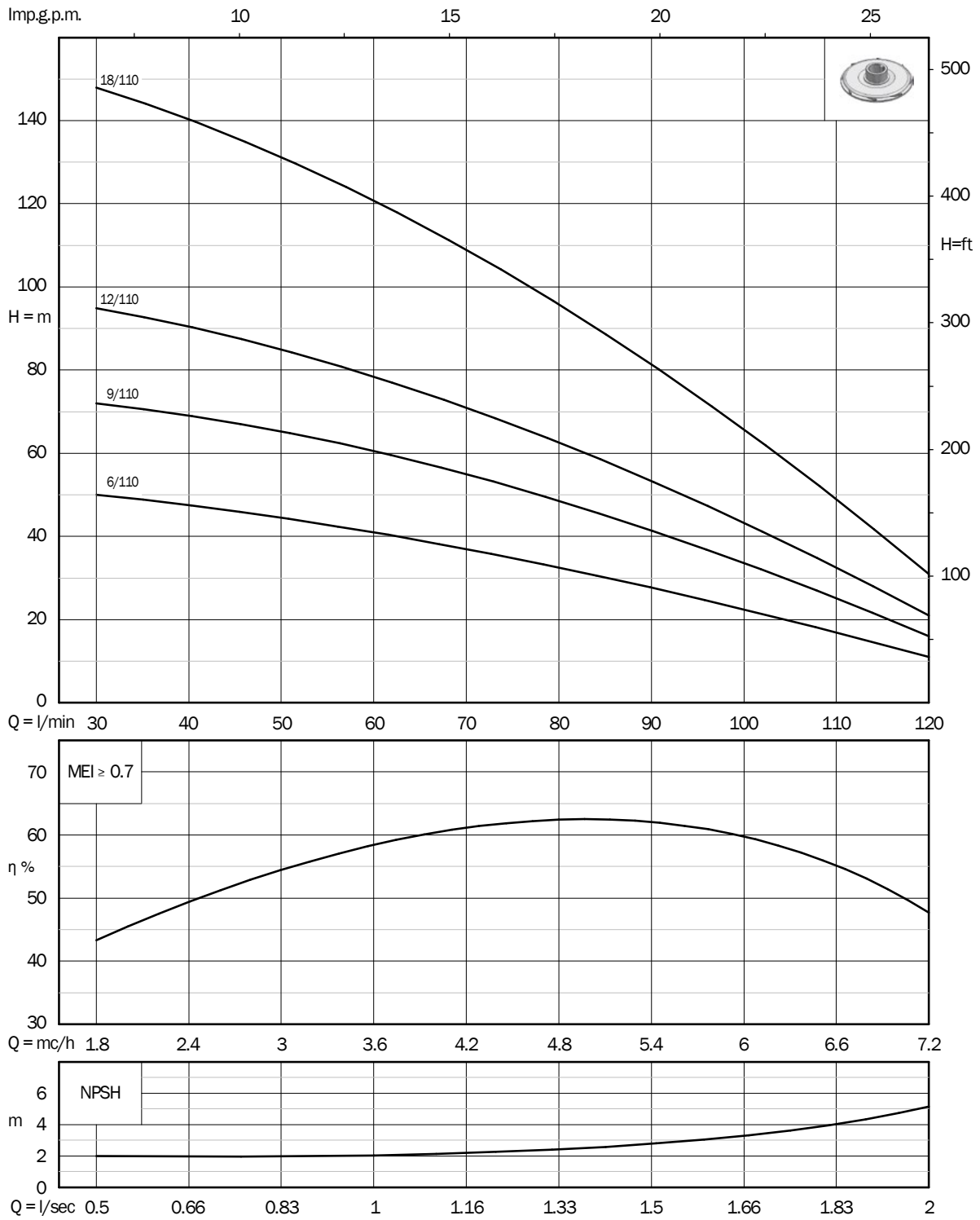

External electric pumps CV series 230

vertical multistage

PERFORMANCE DATA - 2 poles 50 Hz

| Radial impeller  | Code | Version | | P2 | | A | Flow | | DNA | Dimensions (mm) | | | | Weight kg |
|---|------------|---------|---------|-----|-----|------|----------------|----------------|-----|-----------------|-----|-----|----|--------------|
| | | | | hp | kW | | l/min | m | | DNM | A | B | C | |
| CV 5/230 | EM230/05 | 230 V | 1-phase | 1,5 | 1,1 | 7,6 | 50 - 140 - 230 | 46 - 36 - 13 | 1"½ | 662 | 286 | 180 | 51 | 24,1 |
| | ET230/05/2 | 400 V | 3-phase | | | 2,9 | | | | 667 | | | | 23,1 |
| CV 6/230 | EM230/06 | 230 V | 1-phase | 2 | 1,5 | 10,9 | 50 - 140 - 230 | 55 - 42 - 15 | 1"½ | 703 | 322 | 180 | 51 | 25,8 |
| | ET230/06/2 | 400 V | 3-phase | | | 3,3 | | | | | | | | 26,3 |
| CV 8/230 | EM230/08 | 230 V | 1-phase | 3 | 2,2 | 14,5 | 50 - 140 - 230 | 73 - 55 - 20 | 1"½ | 841 | 394 | 180 | 51 | 31,7 |
| | ET230/08/2 | 400 V | 3-phase | | | 4,65 | | | | | | | | 31,7 |
| CV 11/230 | ET230/11/2 | 400 V | 3-phase | 4 | 3 | 6 | 50 - 140 - 230 | 100 - 78 - 33 | 1"½ | 964 | 502 | 180 | 51 | 38 |
| CV 14/230 | ET230/14/2 | 400 V | 3-phase | 5,5 | 4 | 8,4 | 50 - 140 - 230 | 134 - 104 - 43 | 1"½ | 1074 | 610 | 180 | 51 | 44 |



SUPPLIED WITH

Capacitor (single-phase versions)

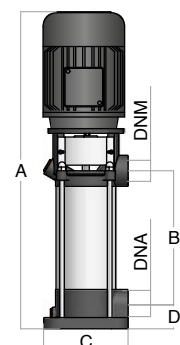
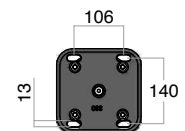

PERFORMANCE CURVES - 2 poles 50 Hz

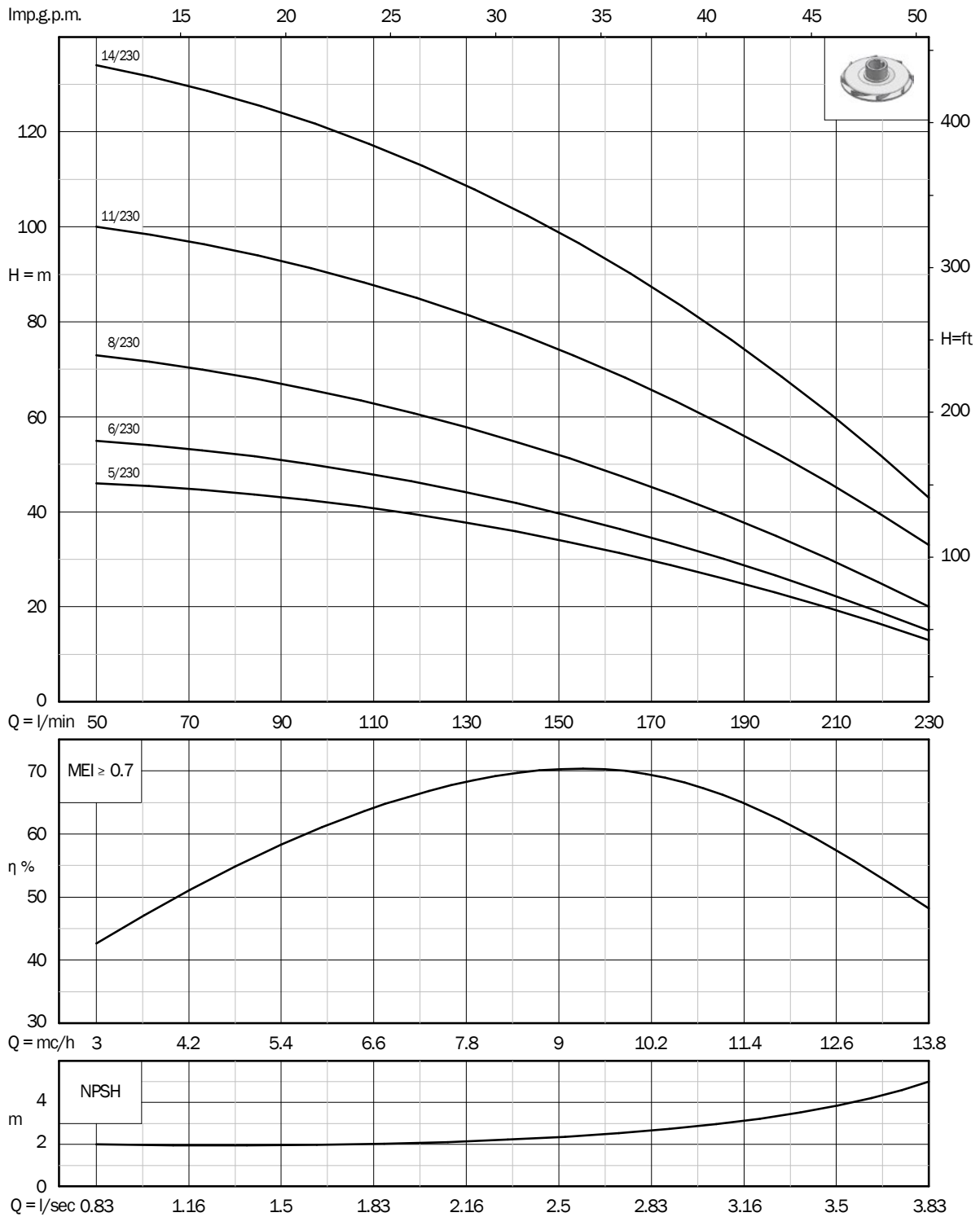

External electric pumps CV series 330

vertical multistage

PERFORMANCE DATA - 2 poles 50 Hz

| Radial impeller  | Code | Version | | P2 | | A | Flow | | DNA | Dimensions (mm) | | | | Weight kg |
|---|------------|---------|---------|-----|-----|------|-----------------|---------------|-----|-----------------|-----|-----|----|--------------|
| | | | | hp | kW | | l/min | m | | DNM | A | B | C | |
| CV 5/330 | EM330/05 | 230 V | 1-phase | 3 | 2,2 | 14,5 | 100 - 230 - 330 | 46 - 32 - 14 | 1"½ | 733 | 286 | 180 | 51 | 29,6 |
| | ET330/05/2 | 400 V | 3-phase | | | 4,65 | | | | 714 | | | | 29,6 |
| CV 7/330 | ET330/07/2 | 400 V | 3-phase | 4 | 3 | 6 | 100 - 230 - 330 | 61 - 45 - 20 | 1"½ | 820 | 358 | 180 | 51 | 35,3 |
| CV 10/330 | ET330/10/2 | 400 V | 3-phase | 5,5 | 4 | 8,4 | 100 - 230 - 330 | 94 - 66 - 29 | 1"½ | 930 | 466 | 180 | 51 | 41,1 |
| CV 14/330 | ET330/14/2 | 400 V | 3-phase | 7,5 | 5,5 | 10,1 | 100 - 230 - 330 | 128 - 88 - 37 | 1"½ | 1083 | 610 | 180 | 51 | 51,5 |



SUPPLIED WITH

Capacitor (single-phase versions)

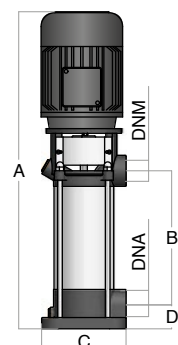
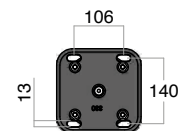

PERFORMANCE CURVES - 2 poles 50 Hz

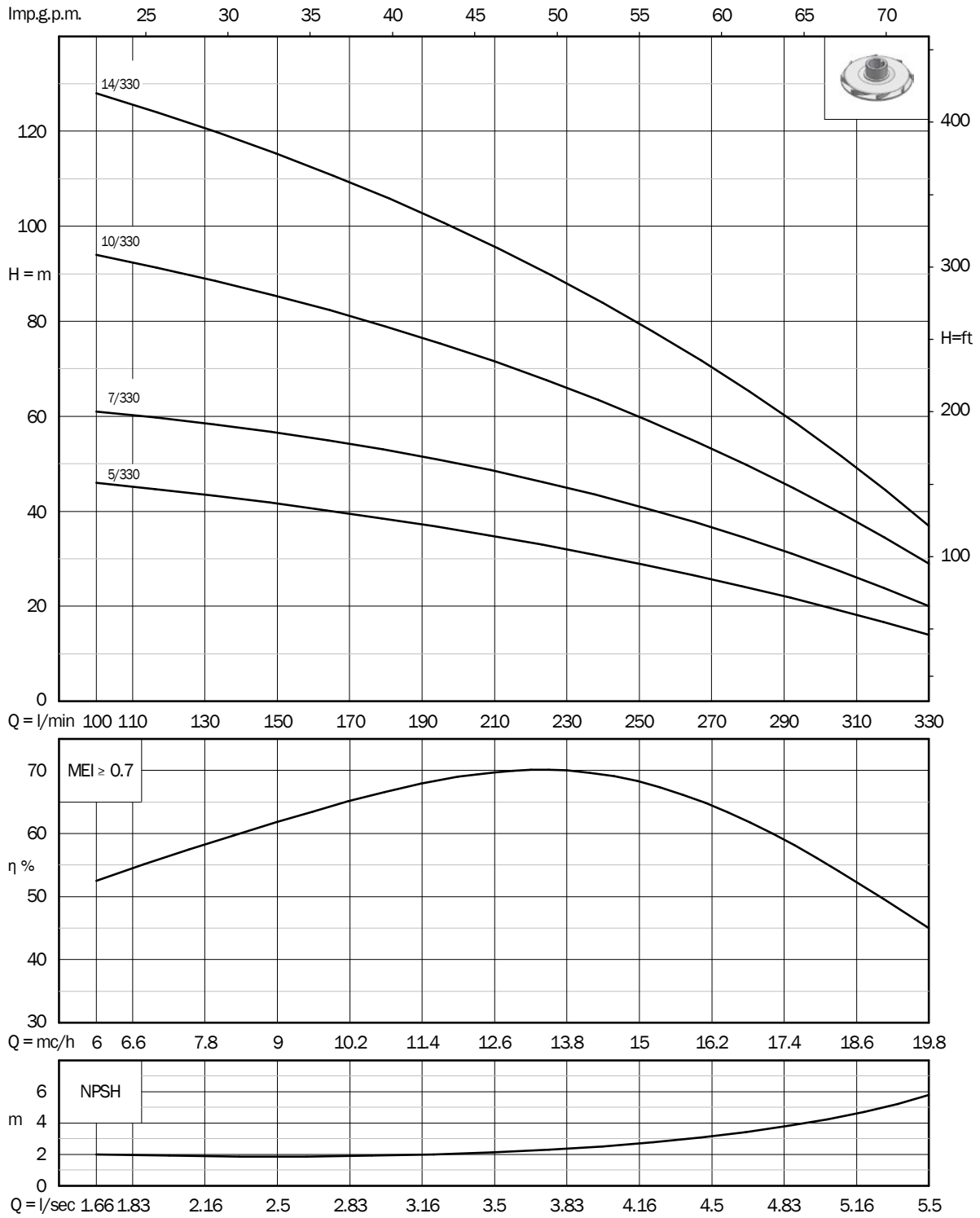

External electric pumps CV series 530

vertical multistage

PERFORMANCE DATA - 2 poles 50 Hz

| Radial impeller  | Code | Version | | P2 | | A | Flow | | DNA | DNM | Dimensions (mm) | | | | Weight kg |
|---|------------|---------|---------|------|-----|------|-----------------|----------------|-----|-----|-----------------|-----|-----|----|--------------|
| | | | | hp | kW | | l/min | m | | | A | B | C | D | |
| | | | | | | | | | | | | | | | |
| CV 4/530 | ET530/04/2 | 400 V | 3-phase | 4 | 3 | 6 | 200 - 330 - 550 | 36 - 32 - 10 | 2"½ | 2" | 861 | 327 | 200 | 68 | 40,2 |
| CV 6/530 | ET530/06/2 | 400 V | 3-phase | 5,5 | 4 | 8,4 | 200 - 330 - 550 | 53 - 48 - 16 | 2"½ | 2" | 963 | 427 | 200 | 68 | 45,7 |
| CV 8/530 | ET530/08/2 | 400 V | 3-phase | 7,5 | 5,5 | 10,1 | 200 - 330 - 550 | 70 - 64 - 21 | 2"½ | 2" | 1072 | 527 | 200 | 68 | 54,7 |
| CV 11/530 | ET530/11/2 | 400 V | 3-phase | 10 | 7,5 | 14,3 | 200 - 330 - 550 | 97 - 87 - 29 | 2"½ | 2" | 1277 | 677 | 200 | 68 | 71,4 |
| CV 14/530 | ET530/14/2 | 400 V | 3-phase | 12,5 | 9,2 | 17,7 | 200 - 330 - 550 | 123 - 111 - 37 | 2"½ | 2" | 1465 | 827 | 200 | 68 | 85,2 |

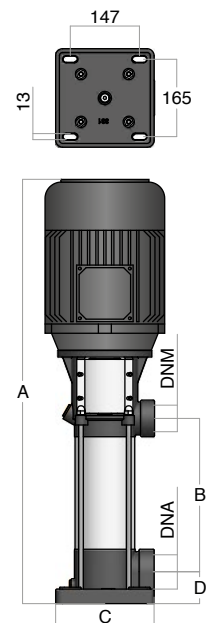

PERFORMANCE CURVES - 2 poles 50 Hz

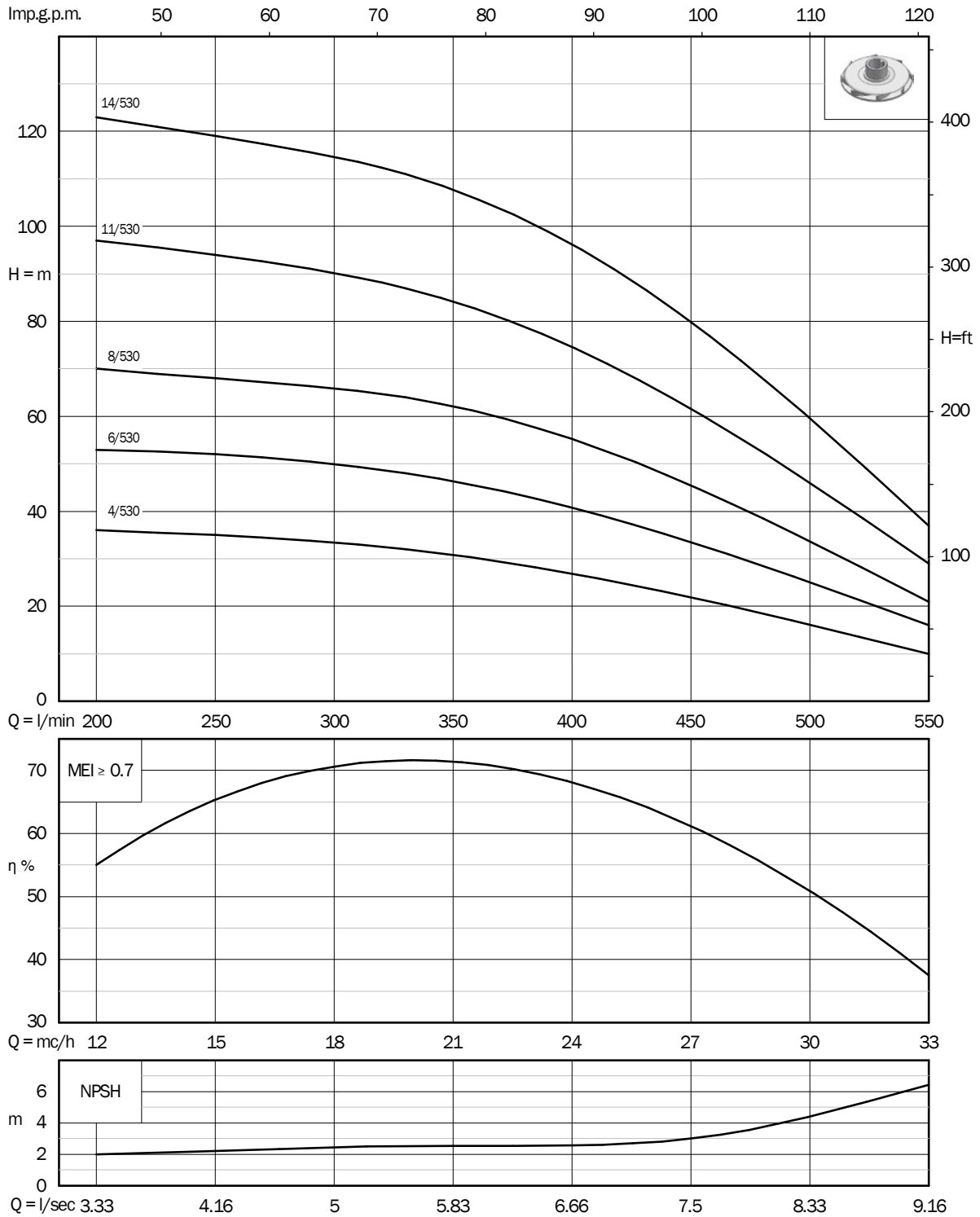

External electric pumps CV series 700

vertical multistage

PERFORMANCE DATA - 2 poles 50 Hz

| Semi-axial impeller  | Code | Version | | P2 | | A | Flow | | DNA | DNM | Dimensions (mm) | | | | Weight kg |
|---|------------|---------|---------|------|-----|------|-----------------|---------------|-----|-----|-----------------|-----|-----|----|--------------|
| | | | | hp | kW | | l/min | m | | | A | B | C | D | |
| | | | | | | | | | | | | | | | |
| CV 3/700 | ET700/03/2 | 400 V | 3-phase | 5,5 | 4 | 8,4 | 300 - 450 - 700 | 35 - 28 - 9 | 2"½ | 2" | 897 | 361 | 200 | 68 | 45,3 |
| CV 5/700 | ET700/05/2 | 400 V | 3-phase | 7,5 | 5,5 | 10,1 | 300 - 450 - 700 | 59 - 46 - 14 | 2"½ | 2" | 1062 | 517 | 200 | 68 | 55,1 |
| CV 6/700 | ET700/06/2 | 400 V | 3-phase | 10 | 7,5 | 14,3 | 300 - 450 - 700 | 68 - 54 - 17 | 2"½ | 2" | 1195 | 595 | 200 | 68 | 70,8 |
| CV 8/700 | ET700/08/2 | 400 V | 3-phase | 12,5 | 9,2 | 17,7 | 300 - 450 - 700 | 93 - 76 - 29 | 2"½ | 2" | 1389 | 751 | 200 | 68 | 84,7 |
| CV 10/700 | ET700/10/1 | 400 V | 3-phase | 15 | 11 | 19,4 | 300 - 450 - 700 | 116 - 96 - 36 | 2"½ | 2" | 1626 | 907 | 200 | 68 | 91,1 |

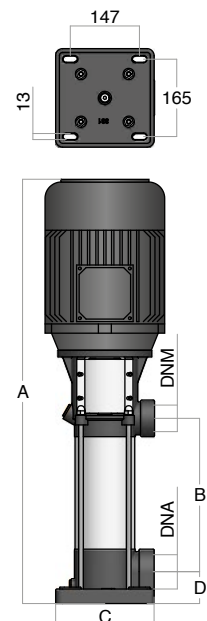

PERFORMANCE CURVES - 2 poles 50 Hz

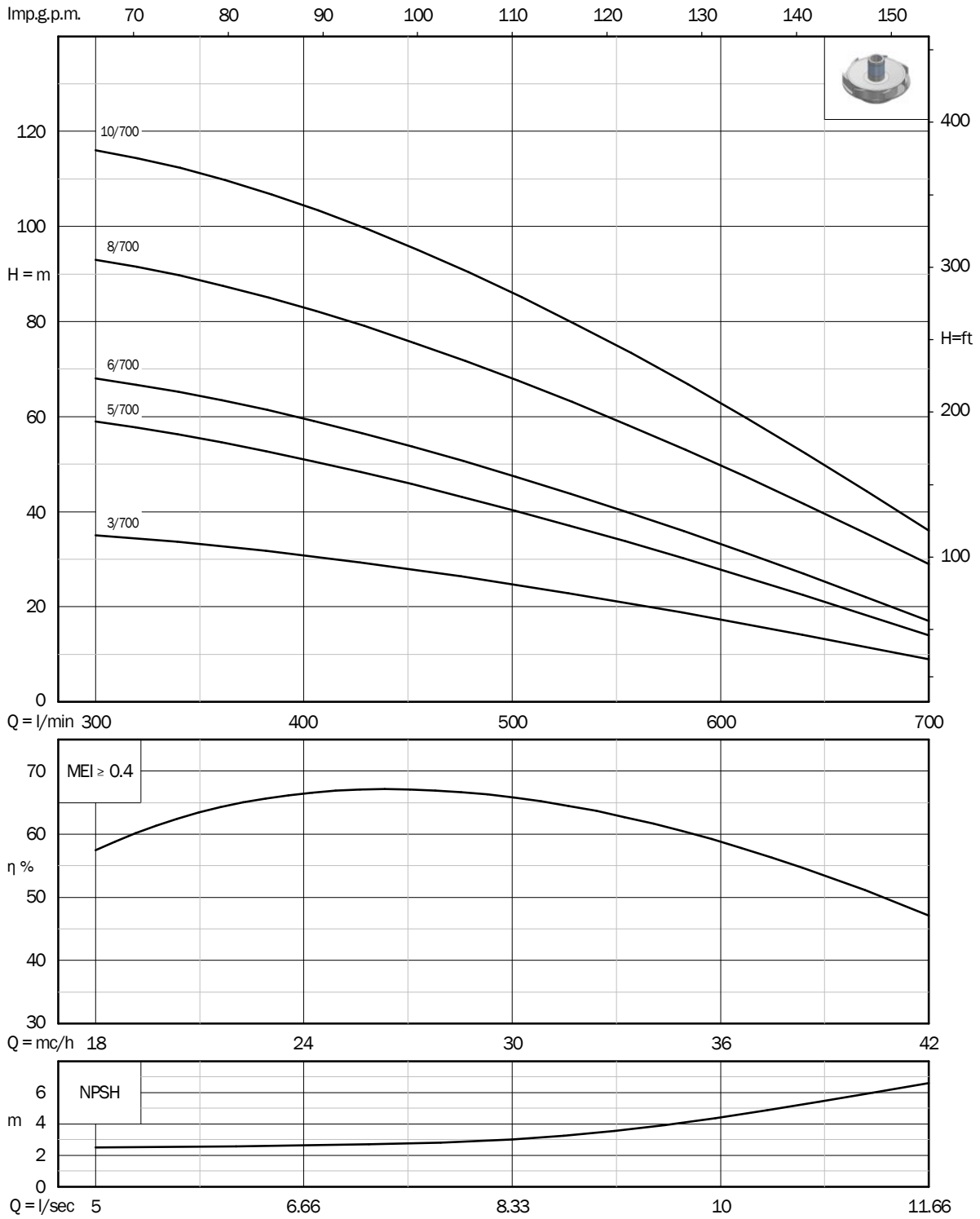

G-CV GI-CV



APPLICATION

To pressurize civil, agricultural and industrial plants

Irrigation

CHARACTERISTICS

| | |
|---|---------------|
| IP rating | IP54 |
| Duty | Continuous S1 |
| Ambient temperature (°C) | -5/+40 |
| Maximum number of starts per hour | 20 |
| Maximum temperature of the liquid pumped (°C) | 80 |
| PH of the liquid pumped | 6 - 10 |
| To be installed in a sheltered place | |

APPLICATION RANGE

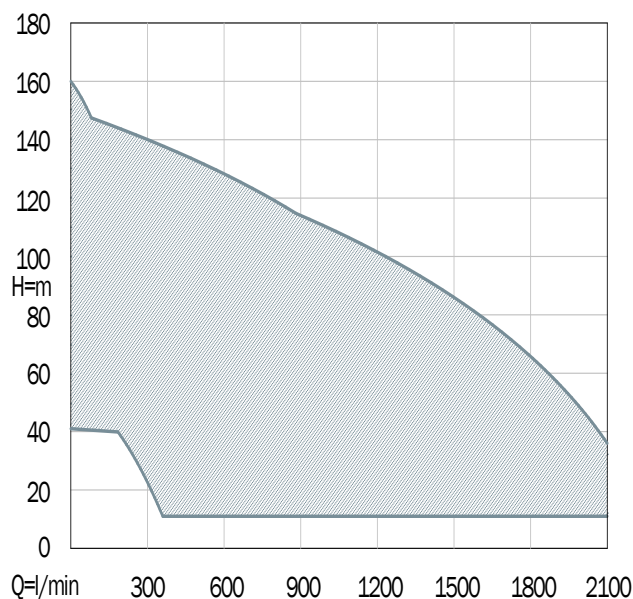

MATERIALS

| | |
|--------------------------------------|---|
| Suction body and discharge | Mechanical cast iron EN GJL-200 |
| Pump casing, tie rods, bolt and nuts | Stainless steel AISI304 |
| Shaft | Stainless steel AISI420B |
| Impellers and diffusers | Noryl® reinforced with fibre-glass, certified for drinking water and AISI304 stainless steel wear rings |
| Coupling | Mechanical cast iron EN GJL-200 |
| Guide ball bearing | Self-lubricating bronze |
| Mechanical seal | Graphite and alumina |
| Diffuser bush | Anti-friction rubber (series 700) |
| Inlet manifold | Zinc-plated steel |
| Discharge manifold | Zinc-plated steel |
| Base and frame | Zinc-plated steel |

Automatic booster sets G-CV

CHARACTERISTICS

| P2 | | Q | H |
|--------------|-----------------|-----------------|---------------|
| hp | kW | l/min | m |
| from 1 to 45 | from 0,75 to 33 | from 30 to 2100 | from 7 to 148 |

MAIN COMPONENTS

Two electric pumps CV (three on request)

N° 2 pressure switches installed on the discharge manifold to start and stop the pumps automatically (alternating - duty-assist)

Inlet manifold with non-return check valves, ball valves and facilities for air feeders

Discharge manifold connected to the electric pumps via ball valves

Pressure gauge

The whole set is assembled on one frame

Plastic control panel containing:

- opening interlocked
- hand - off - auto selector switches, one each electric pump
- electronic card that allows level control, overload protection and alternating duty - assist run of the electric pumps
- 24 V transformer 230-400
- 24 V contactors
- set of fuses for motor protection
- fuses on auxiliary circuit



CHARACTERISTICS

| P2 | | Q | H |
|--------------|-----------------|-----------------|---------------|
| hp | kW | l/min | m |
| from 1 to 45 | from 0,75 to 33 | from 30 to 2100 | from 7 to 148 |

MAIN COMPONENTS

Two electric pumps CV (three on request)

N° 2 pressure trasducers 4÷20 mA installed on the discharge manifold that allow the alternating duty - assist run of the electric pumps (alternating duty: equally distributed according to the actual run-time; assist: according to the request of water)

Inlet manifold with non-return check valves, ball valves and facilities for air feeders

Discharge manifold connected to the electric pumps via ball valves

Pressure gauge

The whole set is assembled on one frame

N° 2 inverters (on the top of the electric pumps) with the following characteristics:

- alarm and protection against dry running
- alarm for low and maximum pressure
- N.O or N.C, adjustable digital outputs (motor run, alarm, pump control)
- analog inputs 4÷20 mA



Dirty water





SEMISOM



Electric submersible pumps SEMISOM

for grey water



APPLICATION

To expel rainwater and liquids coming from electric household appliances

To drain tanks, cellars and garages

To transfer water from pools and fountains

Irrigation

CHARACTERISTICS

| | Semisom | Seminox |
|--|-----------------------------|---------|
| IP rating | IP68 | |
| Duty (versions 1~230V - 3~400V) | Continuous S1 | |
| Duty (versions 24V DC) | Limited use S2 (60 minutes) | |
| Maximum immersion depth (m) | 20 | 5 |
| Maximum number of starts per hour | 40 | 30 |
| Maximum temperature of the liquid pumped versions 1~230V - 3~400V (°C) | 50 | 35 |
| Maximum temperature of the liquid pumped versions 24V DC (°C) | 35 | |
| PH of the liquid pumped | 6 - 10 | |
| Density of the liquid pumped (kg/dm ³) | <1,1 | |
| Suitable for inverter drive | Three-phase versions only | |

APPLICATION RANGE

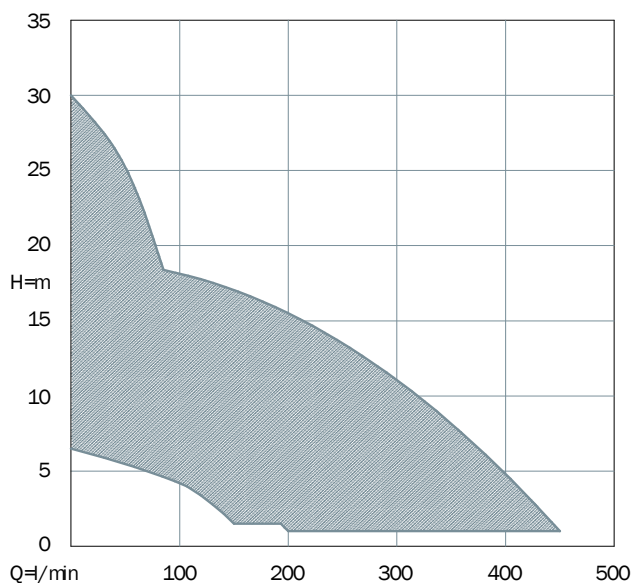

CONSTRUCTION

1~230V - 3~400V versions: coolant filled, asynchronous, rewindable electric AC motor with short circuit rotor. Insulation Class F. Seminox with dry motor. Windings with phase insulators to protect the motor from power peaks, as a guarantee of a highly-trustworthy product.

24V DC with permanent magnets dry electric DC motor. Insulation Class F

Resin-insulated cable kit so to prevent penetration of water inside the motor

Shafts machined on ball bearings and mechanical seals location

Double mechanical seal with oil-chamber in-between

MATERIALS

| | Semisom | Seminox |
|-----------------------------------|---|---|
| Handle, tie-rods and motor casing | Stainless steel AISI304 | |
| Shaft | Stainless steel AISI420B | Stainless steel AISI303 |
| Cover and Volute | Mechanical cast iron EN GJL-250 | Stainless steel AISI304 |
| Tie-rods | Stainless steel AISI304 | |
| Impeller | Mechanical cast iron EN GJL-200 (Semisom 190-130 in tecnopolymer reinforced with fibre glass) | Stainless steel AISI304 (Seminox 155 in tecnopolymer reinforced with fibre glass) |
| Mechanical seal | Silicon carbide and alumina | Graphite and alumina |
| Seal ring | Gomma NBR | |
| Elastomers | NBR rubber | |
| Cable | Neoprene H07RN8-F; 24V DC: Twin Batt | Neoprene H07RN-F |

Electric submersible pumps SEMISOM



for grey water



PERFORMANCE DATA

| Open impeller  | P2 | | 1~230 V | | 3~400 V | 24 V DC | Poles | DNM | Solid passage ø | Q | Flow | | | | | | | | |
|---|------|------|---------|----|---------|---------|-------|-----|-----------------|-------|------|-----|------|------|------|----|-----|-----|-----|
| | hp | kW | Max A | µF | Max A | Max A | | | | | m³/h | 0 | 1,8 | 6 | 9 | 12 | 15 | 18 | 21 |
| SEMISOM 155 | 0,33 | 0,25 | 1,9 | 8 | | | 2 | 1"¼ | 10 | H (m) | 7,6 | 6,8 | 4,3 | 1,5 | | | | | |
| SEMISOM 155 L | 0,33 | 0,25 | 2,2 | 8 | | | 2 | 1"¼ | 20 | | 6,5 | 5,9 | 4,2 | 2,4 | | | | | |
| SEMISOM 190 | 0,5 | 0,37 | 2,5 | 10 | 1,2 | 24 | 2 | 1"¼ | 5 | | 10,5 | 9,5 | 7 | 4 | 1 | | | | |
| SEMISOM 320 | 0,75 | 0,55 | 4,2 | 16 | 1,7 | 28 | 2 | 1"¼ | 13 | | 11,5 | 11 | 9 | 7,5 | 5,5 | 3 | 0,5 | | |
| SEMISOM 465 | 1,5 | 1,1 | 7,3 | 20 | 2,7 | | 2 | 2" | 5 | | 19 | | 17,5 | 16,5 | 15,5 | 14 | 12 | 9,5 | 6,5 |

| Open impeller  | P2 | | 1~230 V | | 3~400 V | 24 V DC | Poles | DNM | Solid passage ø | Q | Flow | | | | | | | | | |
|---|-----|-----|---------|----|---------|---------|-------|-----|-----------------|-------|------|----|------|------|------|-----|---|--|--|--|
| | hp | kW | Max A | µF | Max A | Max A | | | | | m³/h | 0 | 1,2 | 2,4 | 3,6 | 4,8 | 6 | | | |
| SEMISOM 130 | 1,5 | 1,1 | 7,6 | 25 | 2,9 | | 2 | 1"½ | 5 | H (m) | 30 | 29 | 26,5 | 23,5 | 19,5 | 15 | | | | |

AVAILABLE VERSIONS

| Open impeller  | Vertical discharge  | Horizontal discharge  | Single-phase | Single-phase + Float switch | Single-phase + float and Internal capacitor | Three-phase | Three-phase + float | 24 V |
|---|---|---|--------------|-----------------------------|---|-------------|---------------------|------|
| | | | | | | | | |
| SEMISOM 155 | • | | | | VA | | | |
| SEMISOM 155 L | • | | | | VA | | | |
| SEMISOM 190 | • | | VS | VS | VA | VS | | VS |
| SEMISOM 320 | • | | VS | VS | VA | VS | VA | VS |
| SEMISOM 465 | • | | VS | VS | VA | VS | VA | |

| Open impeller  | Vertical discharge  | Horizontal discharge  | Single-phase | Single-phase + Float switch | Single-phase + float and Internal capacitor | Three-phase | Three-phase + float | 24 V |
|---|---|---|--------------|-----------------------------|---|-------------|---------------------|------|
| | | | | | | | | |
| SEMISOM 130 | | • | HS | HS | | HS | | |

V = Vertical discharge; H = Horizontal discharge
S = Standard version; A = Automatic version

PERFORMANCE CURVES

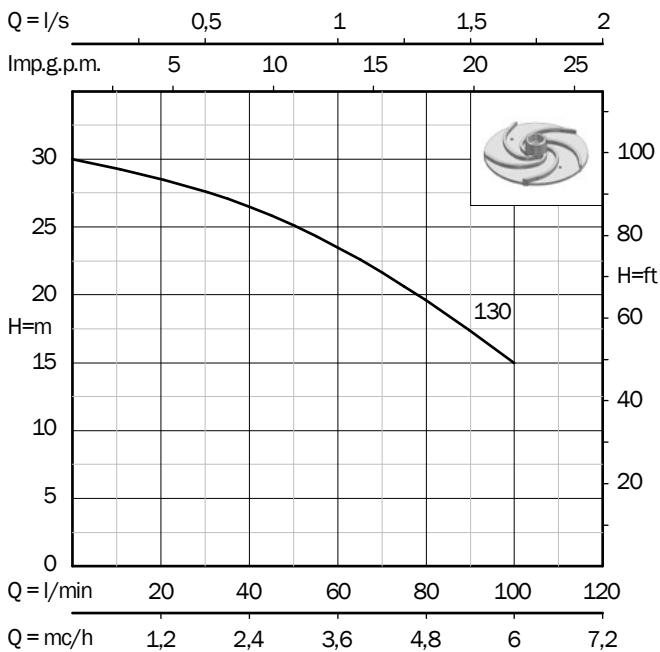
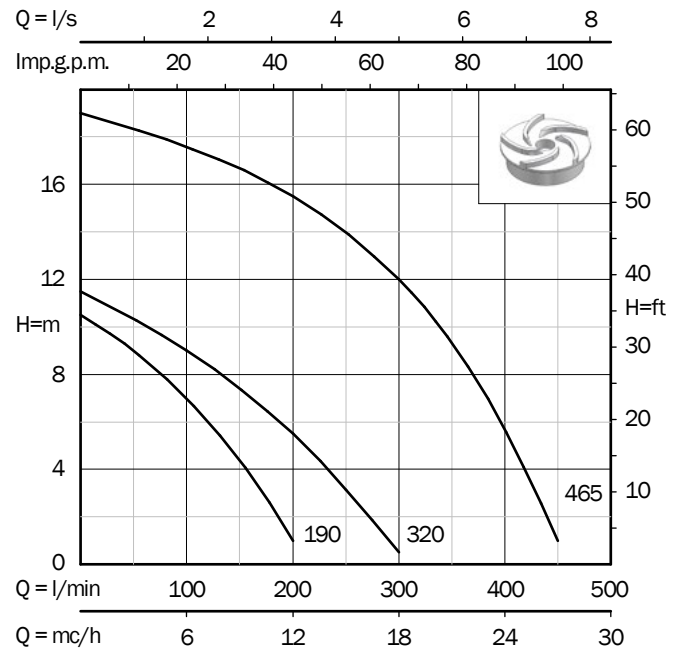
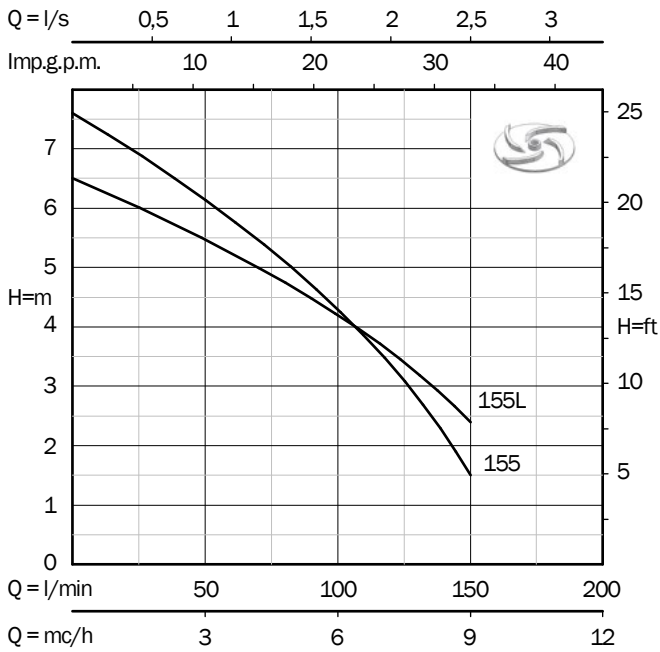

Electric submersible pumps SEMISOM series VA

for grey water, vertical discharge

PERFORMANCE DATA 2 poles 50 Hz

| Open impeller  | Code | Version | | P2 | | Max A | Flow | | Ø solids | DNM | Dimensions (mm) | | | Weight kg |
|---|----------|---------|---------------|------|------|----------|----------|-----------|-------------|-----|-----------------|----|-----|--------------|
| | | | | hp | kW | | l/min | m | | | A | B | C | |
| SEMINOX 155 VA | SM155 | 230 V | 1-phase | 0,33 | 0,25 | 1,9 | 30 - 100 | 6,8 - 4,3 | 10 | 1"¼ | 273 | 20 | 167 | 4,3 |
| | SM155+G | 230 V | 1-phase+float | | | | | | | | | | | 4,6 |
| SEMINOX 155L VA | SM155L+G | 230 V | 1-phase+float | 0,33 | 0,25 | 2,2 | 30 - 100 | 5,9 - 4,2 | 20 | 1"¼ | 304 | 45 | 167 | 5 |



SUPPLIED WITH

5 meters power cable



Capacitor and built-in thermal protector

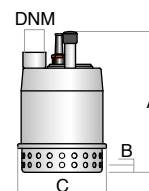

PERFORMANCE DATA 2 poles 50 Hz

| Open impeller  | Code | Version | | P2 | | Max A | Flow | | Ø solids | DNM | Dimensions (mm) | | | | Weight kg |
|---|-----------|---------|---------------|------|------|----------|-----------------|----------------|-------------|-----|-----------------|----|-----|-----|--------------|
| | | | | hp | kW | | l/min | m | | | A | B | C | D | |
| SEMISOM 190 VA | SM190+G/3 | 230 V | 1-phase+float | 0,5 | 0,37 | 2,5 | 30 - 150 - 200 | 9,5 - 4 - 1 | 5 | 1"¼ | 393 | 50 | 225 | 164 | 12,8 |
| SEMISOM 320 VA | SM320+G/3 | 230 V | 1-phase+float | 0,75 | 0,55 | 4,2 | 30 - 200 - 300 | 11 - 5,5 - 0,5 | 13 | 1"¼ | 418 | 50 | 225 | 164 | 14,9 |
| | ST320+G/2 | 400 V | 3-phase+float | | | 1,7 | | | | | | | | | 16,7 |
| SEMISOM 465 VA | SM465+G/3 | 230 V | 1-phase+float | 1,5 | 1,1 | 7,3 | 100 - 300 - 450 | 17,5 - 12 - 1 | 5 | 2" | 484 | 60 | 250 | 172 | 21,8 |
| | ST465+G/2 | 400 V | 3-phase+float | | | 2,7 | | | | | | | | | 23,6 |



SUPPLIED WITH

Power cable:

- 5 meters for single-phase versions
- 10 meters for three-phase versions



Capacitor and thermal protector put in a separate, easy-accessible, water tight chamber (single-phase versions)



Mini-contactor put in a separate, easy-accessible chamber (three-phase versions)

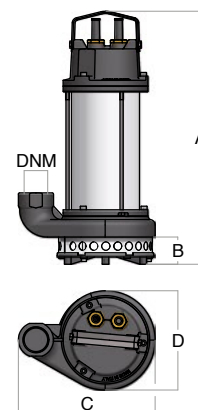

Electric submersible pumps SEMISOM series VS

for grey water, vertical discharge



PERFORMANCE DATA 2 poles 50 Hz

| Open impeller  | Code | Version | | P2 | | Max A | Flow | | Ø solids | DNM | Dimensions (mm) | | | | Weight kg |
|---|---------|---------|---------------|------|------|----------|-----------------|----------------|-------------|-----|-----------------|----|-----|-----|--------------|
| | | | | hp | kW | | l/min | m | | | A | B | C | D | |
| SEMISOM 190 VS | SM190 | 230 V | 1-phase | 0,5 | 0,37 | 2,5 | 30 - 150 - 200 | 9,5 - 4 - 1 | 5 | 1"¼ | 335 | 50 | 225 | 164 | 10,8 |
| | SM190+G | 230 V | 1-phase+float | | | | | | | | | | | | 11 |
| | ST190 | 400 V | 3-phase | 1,2 | 10,8 | | | | | | | | | | |
| SEMISOM 320 VS | SM320 | 230 V | 1-phase | 0,75 | 0,55 | 4,2 | 30 - 200 - 300 | 11 - 5,5 - 0,5 | 13 | 1"¼ | 360 | 50 | 225 | 164 | 13 |
| | SM320+G | 230 V | 1-phase+float | | | | | | | | | | | | 13,2 |
| | ST320 | 400 V | 3-phase | 1,7 | 13 | | | | | | | | | | |
| SEMISOM 465 VS | SM465 | 230 V | 1-phase | 1,5 | 1,1 | 7,3 | 100 - 300 - 450 | 17,5 - 12 - 1 | 5 | 2" | 440 | 60 | 250 | 172 | 19,5 |
| | SM465+G | 230 V | 1-phase+float | | | | | | | | | | | | 19,7 |
| | ST465 | 400 V | 3-phase | 2,7 | 19,5 | | | | | | | | | | |

PERFORMANCE DATA - 24 V DC

| Open impeller  | Code | Version | | P2 | | P1 kW | Max A | Flow | | Ø solids | DNM | Dimensions (mm) | | | | Weight kg |
|--|-------|---------|----|------|------|----------|----------|----------------|----------------|-------------|-----|-----------------|----|-----|-----|--------------|
| | | | | hp | kW | | | l/min | m | | | A | B | C | D | |
| SEMISOM 190 VS | SF190 | 24 V | DC | 0,5 | 0,37 | 0,58 | 24 | 30 - 150 - 200 | 9,5 - 4 - 1 | 5 | 1"¼ | 385 | 50 | 225 | 164 | 10,2 |
| SEMISOM 320 VS | SF320 | 24 V | DC | 0,75 | 0,55 | 0,67 | 28 | 30 - 200 - 300 | 11 - 5,5 - 0,5 | 13 | 1"¼ | 400 | 50 | 225 | 164 | 11,6 |

P1: Max. absorbed power - P2: Nominal power of the motor



SUPPLIED WITH

5 meters power cable



Control box containing capacitor and amperometric protection (single-phase versions)

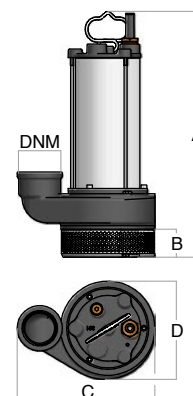

ACCESSORIES

| Code | Description |
|----------|---|
| 02076100 | QDC electromechanical direct starter (24 V DC versions) |



Electric submersible pumps SEMISOM series HS

for grey water, horizontal discharge

PERFORMANCE DATA 2 poles 50 Hz

| Open impeller  | Code | Version | | P2 | | Max A | Flow | | Ø solids | DNM | Dimensions (mm) | | | | Weight kg |
|---|---------|---------|---------------|-----|-----|----------|---------------|----------------|-------------|-----|-----------------|----|-----|-----|--------------|
| | | | | hp | kW | | l/min | m | | | A | B | C | D | |
| SEMISOM 130 HS | SM130 | 230 V | 1-phase | 1,5 | 1,1 | 7,6 | 20 - 60 - 100 | 29 - 23,5 - 15 | 5 | 1"½ | 426 | 69 | 240 | 190 | 22,2 |
| | SM130+G | 230 V | 1-phase+float | | | 2,9 | | | | | | | | | 22,4 |
| | ST130 | 400 V | 3-phase | | | 2,9 | | | | | | | | | 22,2 |



SUPPLIED WITH

10 meters power cable



Control box containing capacitor and amperometric protection (single-phase versions)

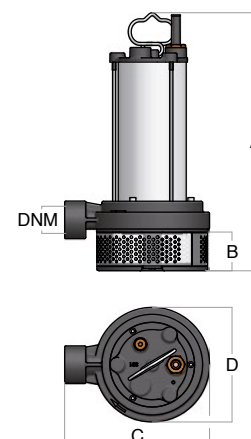
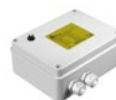

ACCESSORIES

| Code | Description |
|----------|---|
| 04105042 | Guide rail kit DNM 1"½ (¾" guide poles are not included) |

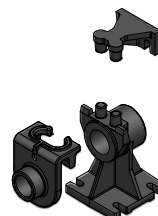
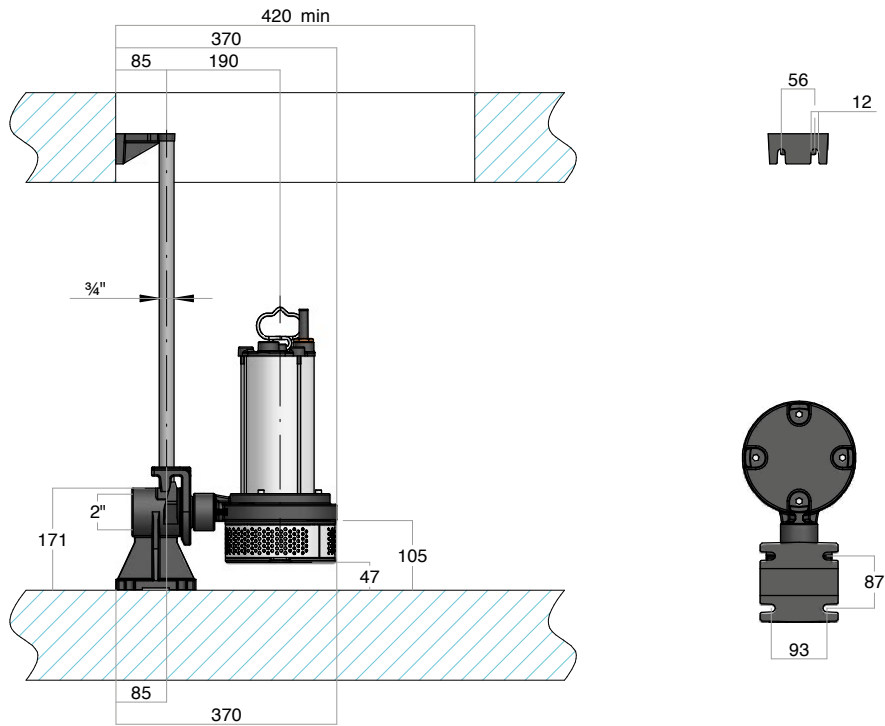

ILLUSTRATION OF AN INSTALLATION WITH GUIDE RAIL KIT



SEMISOM



Electric submersible pumps SEMISOM

for sewage water



APPLICATION

To expel rain water, convey waste and sewage water from septic tanks

To pump liquids containing solids (vortex or double channel impeller) and filaments (double channel impeller)

To pump sewage keeping its biological process unchanged (Semisom 504 4 poles)

CHARACTERISTICS

| | |
|--|--------------------------------|
| IP rating | IP68 |
| Duty (versions 1~230V - 3~400V) | Continuous S1 |
| Duty (versions 24V DC) | Limited use S2 (60 minutes) |
| Maximum immersion depth (m) | 20 |
| Maximum number of starts per hour | 40 |
| Maximum temperature of the liquid pumped versions 1~230V - 3~400V (°C) | 50 |
| Maximum temperature of the liquid pumped versions 24V DC (°C) | 35 |
| PH of the liquid pumped | 6 - 10 |
| Density of the liquid pumped (kg/dm ³) | <1,1 |
| Suitable for inverter drive | Three-phase versions only |

APPLICATION RANGE

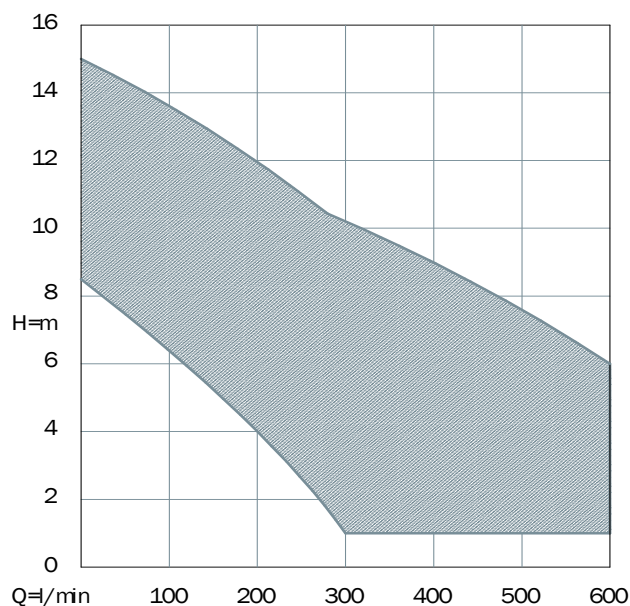

CONSTRUCTION

1~230V - 3~400V versions: coolant filled, asynchronous, rewindable electric AC motor with short circuit rotor. Insulation Class F. Windings with phase insulators to protect the motor from power peaks, as a guarantee of a highly-trustworthy product.

24V DC versions: with permanent magnets dry electric DC motor. Insulation Class F

Resin-insulated cable kit to prevent penetration of water inside the motor

Shafts machined on ball bearings and mechanical seals location

Double mechanical seal with oil-chamber in-between

MATERIALS

| | |
|--|--------------------------------------|
| Tie rods, handle, motor casing, bolts and nuts | Stainless Steel AISI304 |
| Shaft | Stainless Steel AISI420B |
| Cover and volute | Mechanical cast iron EN GJL-250 |
| Impeller | Mechanical cast iron EN GJL-200 |
| Mechanical seal | Silicon carbide and alumina |
| Packing Ring | NBR rubber |
| Elastomers | NBR rubber |
| Cable | Neoprene H07RN8-F; 24V DC: Twin Batt |

Electric submersible pumps SEMISOM





for sewage water





PERFORMANCE DATA

| Vortex Impeller  | P2 | | 1~230 V | | 3~400 V | 24 V DC | Poles | DNM | Solid Passage ø | Q | | Flow | | | | | | | | | |
|---|------|------|---------|------|---------|---------|-------|-----|--------------------|----------|------|------|------|------|------|------|-----|-----|-----|-----|-----|
| | hp | kW | Max | μF | Max | Max | | | | m³/h | 0 | 6 | 9 | 12 | 15 | 18 | 21 | 24 | 27 | 30 | 36 |
| | | | A | | A | A | | | | l/min | 0 | 100 | 150 | 200 | 250 | 300 | 350 | 400 | 450 | 500 | 600 |
| SEMISOM 265 | 0,75 | 0,55 | 4,2 | 16 | 1,7 | 28 | 2 | 1"½ | 40 | H (m) | 8,5 | 6,5 | 5,5 | 4 | 3 | 1 | | | | | |
| SEMISOM 290 | 0,75 | 0,55 | 4,2 | 16 | 1,7 | | 2 | 2" | 50 | | 8,5 | 7 | 6,5 | 5,5 | 4,5 | 3,5 | 2,5 | 1 | | | |
| SEMISOM 390 | 1 | 0,75 | 5,5 | 16 | 2,3 | | 2 | 2" | 50 | | 10 | 8,5 | 8 | 7 | 6 | 5 | 4 | 3 | 2 | 1 | |
| NEW SEMISOM 504 | 1 | 0,75 | 6,1 | 20 | 2,5 | | 4 | 2" | 50 | | 6,2 | 6 | 5,7 | 5,4 | 5,1 | 4,8 | 4,5 | 4,2 | 3,8 | 3 | |
| SEMISOM 490 | 1,5 | 1,1 | 7,3 | 20 | 2,7 | | 2 | 2" | 50 | | 11 | 9,5 | 9 | 8 | 7,5 | 6,5 | 5,5 | 5 | 4 | 3 | 1 |
| SEMISOM 590 | 2 | 1,5 | 10,5 | 31,5 | 4,1 | | 2 | 2" | 50 | | 14,5 | 13 | 12,5 | 11,5 | 11 | 10 | 9 | 8 | 7,5 | 6,5 | 5 |
| SEMISOM 650 | 2 | 1,5 | 12 | 31,5 | 4,6 | | 2 | 2"½ | 65 | | 9 | 8 | 7,5 | 7 | 6,5 | 6 | 5,5 | 5 | 4,5 | 4 | 3 |
| NEW SEMISOM 650 H | 2 | 1,5 | 12 | 31,5 | 4,6 | | 2 | 2"½ | 65 | | 12,8 | 12 | 11,6 | 11,1 | 10,7 | 10,2 | 9,5 | 8,8 | 8,1 | 7,5 | 6 |

| Channel impeller  | P2 | | 1~230 V | | 3~400 V | 24 V DC | Poles | DNM | Solid Passage ø | Q | | Flow | | | | | | | | | |
|--|------|------|---------|----|---------|---------|-------|-----|--------------------|----------|------|------|-----|-----|-----|-----|-----|-----|-----|-----|-----|
| | hp | kW | Max | μF | Max | Max | | | | m³/h | 0 | 6 | 9 | 12 | 15 | 18 | 21 | 24 | 27 | 30 | 36 |
| | | | A | | A | A | | | | l/min | 0 | 100 | 150 | 200 | 250 | 300 | 350 | 400 | 450 | 500 | 600 |
| SEMISOM 262 | 0,75 | 0,55 | 4,2 | 16 | 1,7 | 28 | 2 | 2" | 32 | H (m) | 10,5 | 9 | 8 | 7 | 6 | 4,5 | 3 | 1 | | | |
| SEMISOM 635 | 1,5 | 1,1 | 7,3 | 20 | 2,7 | | 2 | 2" | 32 | | 15 | 13,5 | 13 | 12 | 11 | 10 | 9 | 7,5 | 6,5 | 5 | 2 |

AVAILABLE VERSIONS

| Vortex Impeller  | Vertical discharge  | Horizontal discharge  | Rail  | Single-phase | Single-phase + Float switch | Single-phase + float. and Internal capacitor | Three-phase | Three-phase + float | 24 V |
|---|---|---|---|--------------|-----------------------------|--|-------------|---------------------|------|
| | SERIES | | | | | | | | |
| SEMISOM 265 | • | | | VS | VS | VA | VS | VA | VS |
| SEMISOM 290 | | • | | HS | HS | HA | HS | | |
| SEMISOM 390 | • | | | VS | VS | VA | VS | VA | |
| NEW SEMISOM 504 | | • | | HS | HS | | HS | | |
| SEMISOM 490 | • | | | VS | VS | VA | VS | VA | |
| SEMISOM 590 | | • | | HS | HS | HA | HS | | |
| SEMISOM 650 | | | • | RS | RS | | RS | | |
| NEW SEMISOM 650 H | | | • | RS | RS | | RS | | |

| Channel impeller  | Vertical discharge  | Horizontal discharge  | Rail  | Single-phase | Single-phase + Float switch | Single-phase + float. and Internal capacitor | Three-phase | Three-phase + float | 24 V |
|--|---|---|---|--------------|-----------------------------|--|-------------|---------------------|------|
| | SERIES | | | | | | | | |
| SEMISOM 262 | • | | | VS | VS | VA | VS | VA | VS |
| SEMISOM 635 | • | | | VS | VS | VA | VS | VA | |
| | | • | | HS | HS | HA | HS | | |

V = Vertical discharge; H = Horizontal discharge; R = Rail
S = Standard version; A = Automatic version

PERFORMANCE CURVES

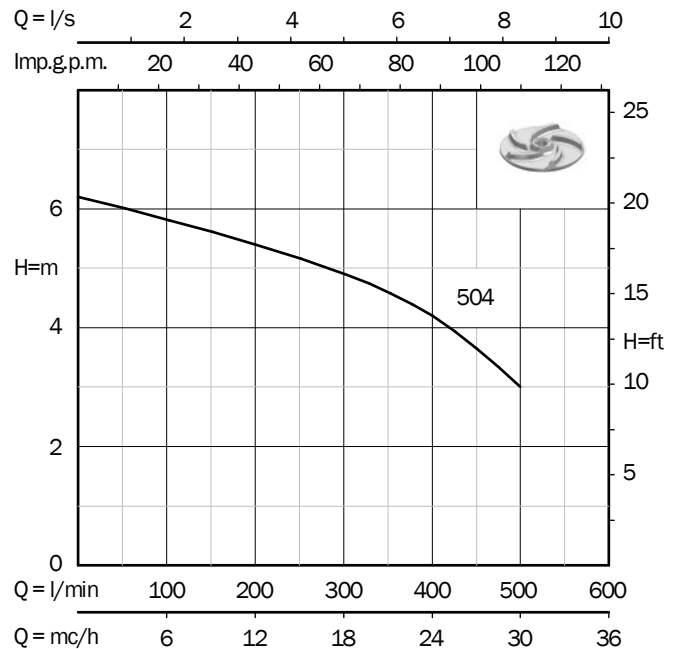
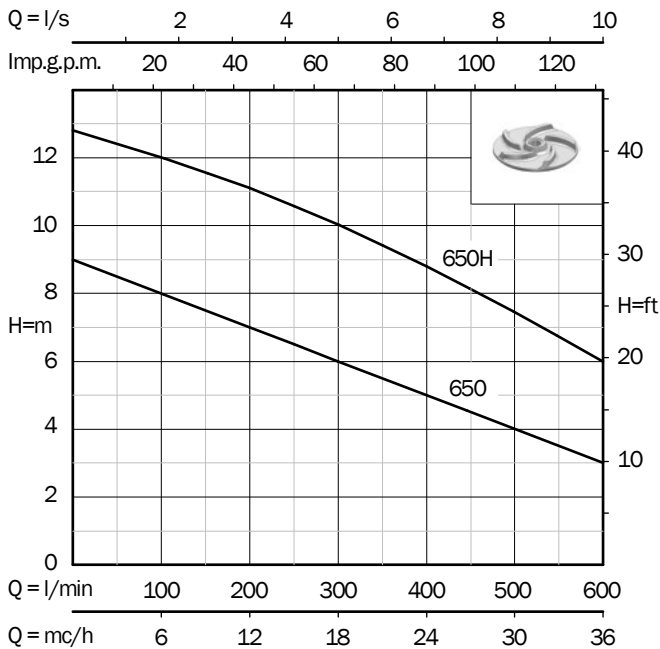
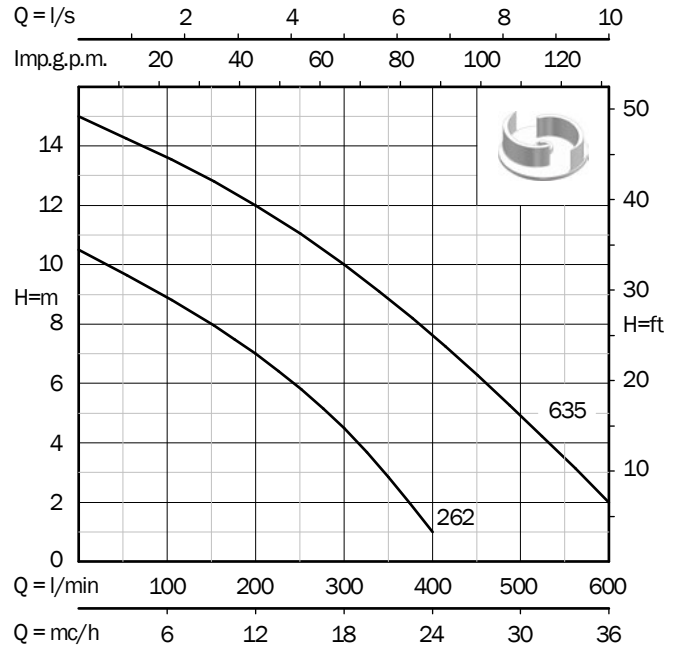
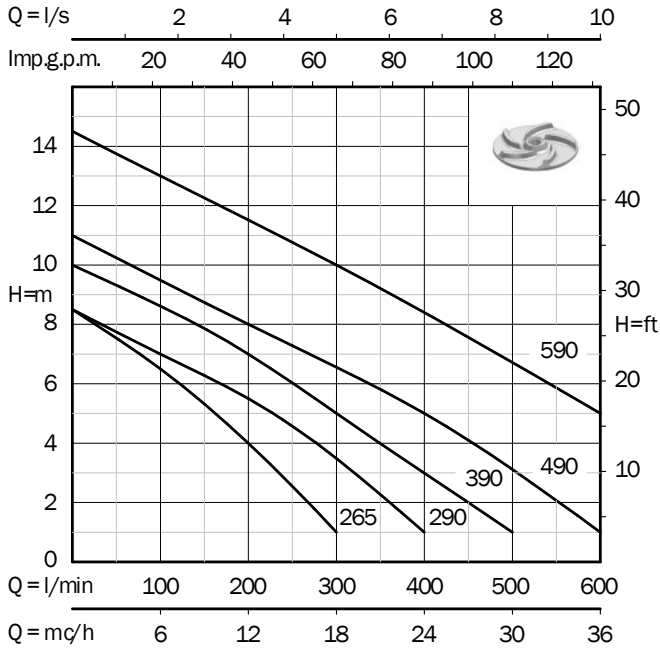

Electric submersible pumps SEMISOM series VA

for sewage water, vertical discharge

PERFORMANCE DATA 2 poles 50 Hz

| Vortex Impeller  | Code | Version | | P2 | | Max | Flow | | Ø solids | DNM | Dimensions (mm) | | | | Weight kg |
|---|-------------|---------|---------------|------|------|-----|-----------------|---------------|----------|-----|-----------------|----|-----|-----|--------------|
| | | | | hp | kW | A | l/min | m | | | A | B | C | D | |
| SEMISOM 265 VA | SM265+GGH/3 | 230 V | 1-phase+float | 0,75 | 0,55 | 4,2 | 30 - 150 - 300 | 8 - 5,5 - 1 | 40 | 1"½ | 454 | 50 | 230 | 162 | 16,5 |
| | ST265+GGH/2 | 400 V | 3-phase+float | | | 1,7 | | | | | | | | | 18,3 |
| SEMISOM 390 VA | SM390+G/3 | 230 V | 1-phase+float | 1 | 0,75 | 5,5 | 100 - 250 - 500 | 8,5 - 6 - 1 | 50 | 2" | 502 | 65 | 235 | 162 | 17,7 |
| | ST390+G/2 | 400 V | 3-phase+float | | | 2,3 | | | | | | | | | 19,5 |
| SEMISOM 490 VA | SM490+G/3 | 230 V | 1-phase+float | 1,5 | 1,1 | 7,3 | 100 - 250 - 600 | 9,5 - 7,5 - 1 | 50 | 2" | 527 | 65 | 235 | 162 | 19,5 |
| | ST490+G/2 | 400 V | 3-phase+float | | | 2,7 | | | | | | | | | 21,3 |

SUPPLIED WITH

Power cable:
 • 5 meters for single-phase versions
 • 10 meters for three-phase versions



Capacitor and thermal protector put in a separate, easy-accessible, water tight chamber (single-phase versions)



Mini-contactor put in a separate, easy-accessible chamber (three-phase versions)

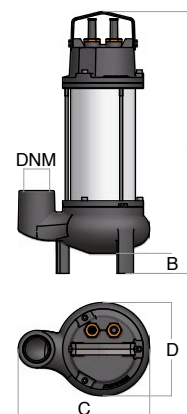

PERFORMANCE DATA 2 poles 50 Hz

| Channel impeller  | Code | Version | | P2 | | Max | Flow | | Ø solids | DNM | Dimensions (mm) | | | | Weight |
|--|-----------|---------|---------------|------|------|-----|----------------|--------------|----------|-----|-----------------|----|-----|-----|--------|
| | | | | hp | kW | A | l/min | m | | | A | B | C | D | kg |
| SEMISOM 262 VA | SM262+G/3 | 230 V | 1-phase+float | 0,75 | 0,55 | 4,2 | 30 - 200 - 400 | 10 - 7 - 1 | 32 | 2" | 450 | 60 | 250 | 172 | 19,1 |
| | ST262+G/2 | 400 V | 3-phase+float | | | 1,7 | | | | | | | | | 20,9 |
| SEMISOM 635 VA | SM635+G/3 | 230 V | 1-phase+float | 1,5 | 1,1 | 7,3 | 30 - 350 - 600 | 14,5 - 9 - 2 | 32 | 2" | 484 | 60 | 250 | 172 | 21,3 |
| | ST635+G/2 | 400 V | 3-phase+float | | | 2,7 | | | | | | | | | 23,1 |

SUPPLIED WITH



Power cable:
 • 5 meters for single-phase versions
 • 10 meters for three-phase versions



Capacitor and thermal protector put in a separate, easy-accessible, water tight chamber (single-phase versions)



Mini-contactor put in a separate, easy-accessible chamber (three-phase versions)

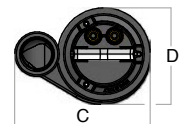
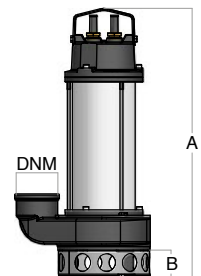

Electric submersible pumps SEMISOM series VS

for sewage water, vertical discharge

PERFORMANCE DATA 2 poles 50 Hz

| Vortex Impeller  | Code | Version | | P2 | | Max A | Flow | | Ø solids | DNM | Dimensions (mm) | | | | Weight kg |
|---|-----------|---------|---------------|------|------|----------|-----------------|---------------|-------------|-----|-----------------|----|-----|-----|--------------|
| | | | | hp | kW | | l/min | m | | | A | B | C | D | |
| SEMISOM 265 VS | SM265GH | 230 V | 1-phase | 0,75 | 0,55 | 4,2 | 30 - 150 - 300 | 8 - 5,5 - 1 | 40 | 1"½ | 400 | 50 | 230 | 162 | 14 |
| | SM265+GGH | 230 V | 1-phase+float | | | | | | | | | | | | 14,2 |
| | ST265GH | 400 V | 3-phase | | | | | | | | | | | | 1,7 |
| SEMISOM 390 VS | SM390 | 230 V | 1-phase | 1 | 0,75 | 5,5 | 100 - 250 - 500 | 8,5 - 6 - 1 | 50 | 2" | 450 | 65 | 235 | 162 | 15,7 |
| | SM390+G | 230 V | 1-phase+float | | | | | | | | | | | | 15,9 |
| | ST390 | 400 V | 3-phase | | | | | | | | | | | | 2,3 |
| SEMISOM 490 VS | SM490 | 230 V | 1-phase | 1,5 | 1,1 | 7,3 | 100 - 250 - 600 | 9,5 - 7,5 - 1 | 50 | 2" | 474 | 65 | 235 | 162 | 16,5 |
| | SM490+G | 230 V | 1-phase+float | | | | | | | | | | | | 16,7 |
| | ST490 | 400 V | 3-phase | | | | | | | | | | | | 2,7 |

PERFORMANCE DATA - 24 V DC

| Vortex Impeller  | Code | Version | | P2 | | P1 kW | Max A | Flow | | Ø solids | DNM | Dimensions (mm) | | | | Weight kg |
|---|-------|---------|----|------|------|----------|----------|----------------|-------------|-------------|-----|-----------------|----|-----|-----|--------------|
| | | | | hp | kW | | | l/min | m | | | A | B | C | D | |
| SEMISOM 265 VS | SF265 | 24 V | DC | 0,75 | 0,55 | 0,67 | 28 | 30 - 150 - 300 | 8 - 5,5 - 1 | 40 | 1"½ | 400 | 50 | 230 | 162 | 13 |

P1: Max. absorbed power - P2: Nominal power of the motor



SUPPLIED WITH

5 meters power cable



Control box containing capacitor and amperometric protection (single-phase versions)

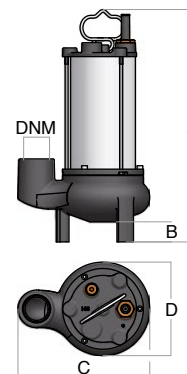

ACCESSORIES

| Code | Description |
|----------|---|
| 02076100 | QDC electromechanical direct starter (24 V DC versions) |



PERFORMANCE DATA 2 poles 50 Hz

| Channel impeller  | Code | Version | | P2 | | Max | Flow | | Ø solids | DNM | Dimensions (mm) | | | | Weight |
|--|---------|---------|---------------|------|------|-----|----------------|--------------|----------|-----|-----------------|----|-----|-----|--------|
| | | | | hp | kW | A | l/min | m | | | A | B | C | D | kg |
| SEMISOM 262 VS | SM262 | 230 V | 1-phase | 0,75 | 0,55 | 4,2 | 30 - 200 - 400 | 10 - 7 - 1 | 32 | 2" | 400 | 60 | 250 | 172 | 16,7 |
| | SM262+G | 230 V | 1-phase+float | | | | | | | | | | | | 16,9 |
| | ST262 | 400 V | 3-phase | | | | | | | | | | | | 1,7 |
| SEMISOM 635 VS | SM635 | 230 V | 1-phase | 1,5 | 1,1 | 7,3 | 30 - 350 - 600 | 14,5 - 9 - 2 | 32 | 2" | 440 | 60 | 250 | 172 | 19,3 |
| | SM635+G | 230 V | 1-phase+float | | | | | | | | | | | | 19,5 |
| | ST635 | 400 V | 3-phase | | | | | | | | | | | | 2,7 |

PERFORMANCE DATA - 24 V DC

| Channel impeller  | Code | Version | | P2 | | P1 | Max | Flow | | Ø solids | DNM | Dimensions (mm) | | | | Weight |
|--|-------|---------|----|------|------|------|-----|----------------|------------|----------|-----|-----------------|----|-----|-----|--------|
| | | | | hp | kW | kW | A | l/min | m | | | A | B | C | D | kg |
| SEMISOM 262 VS | SF262 | 24 V | DC | 0,75 | 0,55 | 0,67 | 28 | 30 - 200 - 400 | 10 - 7 - 1 | 32 | 2" | 400 | 60 | 250 | 172 | 15,3 |

P1: Max. absorbed power - P2: Nominal power of the motor



SUPPLIED WITH

5 meters power cable



Control box containing capacitor and amperometric protection (single-phase versions)

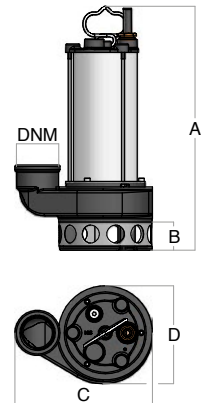

ACCESSORIES

| Code | Description |
|----------|---|
| 02076100 | QDC electromechanical direct starter (24 V DC versions) |



Electric submersible pumps SEMISOM series HA

for sewage water, horizontal discharge

PERFORMANCE DATA 2 poles 50 Hz

| Vortex Impeller  | Code | Version | | P2 | | Max | Flow | | Ø solids | DNM | Dimensions (mm) | | | | Weight kg |
|---|------------|---------|---------------|------|------|-----|-----------------|---------------|----------|-----|-----------------|----|-----|-----|--------------|
| | | | | hp | kW | A | l/min | m | | | A | B | C | D | |
| SEMISOM 290 HA | SM290+GO/3 | 230 V | 1-phase+float | 0,75 | 0,55 | 4,2 | 100 - 200 - 400 | 7 - 5,5 - 1 | 50 | 2" | 492 | 65 | 198 | 162 | 16,4 |
| SEMISOM 390 HA | SM390+GO/3 | 230 V | 1-phase+float | 1 | 0,75 | 5,5 | 100 - 250 - 500 | 8,5 - 6 - 1 | 50 | 2" | 502 | 65 | 198 | 162 | 17,5 |
| SEMISOM 490 HA | SM490+GO/3 | 230 V | 1-phase+float | 1,5 | 1,1 | 7,3 | 100 - 250 - 600 | 9,5 - 7,5 - 1 | 50 | 2" | 526 | 65 | 198 | 162 | 18,8 |



SUPPLIED WITH

10 meters power cable



Capacitor and thermal protector put in a separate, easy-accessible, water tight chamber

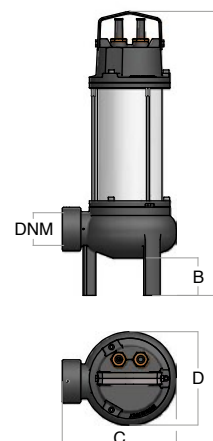

ACCESSORIES

| Code | Description |
|----------|--|
| 04105043 | Guide rail kit DNM 2" ($\frac{3}{4}$ " guide poles are not included) |

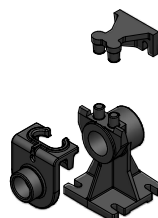

PERFORMANCE DATA 2 poles 50 Hz

| Channel impeller  | Code | Version | | P2 | | Max A | Flow | | Ø solids | DNM | Dimensions (mm) | | | | Weight kg |
|--|------------|---------|---------------|-----|-----|----------|----------------|--------------|-------------|-----|-----------------|----|-----|-----|--------------|
| | | | | hp | kW | | l/min | m | | | A | B | C | D | |
| SEMISOM 635 HA | SM635+G0/3 | 230 V | 1-phase+float | 1,5 | 1,1 | 7,3 | 30 - 350 - 600 | 14,5 - 9 - 2 | 32 | 2" | 484 | 60 | 220 | 172 | 22 |



SUPPLIED WITH

10 meters power cable



Capacitor and thermal protector put in a separate, easy-accessible, water tight chamber

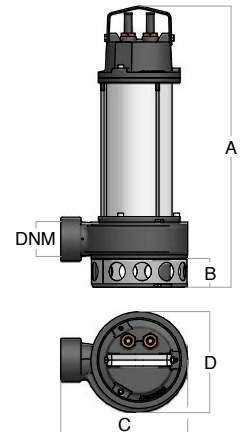

ACCESSORIES

| Code | Description |
|----------|--|
| 04105043 | Guide rail kit DNM 2" ($\frac{3}{4}$ " guide poles are not included) |

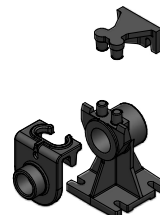

Electric submersible pumps SEMISOM series HS

for sewage water, horizontal discharge

PERFORMANCE DATA 2 poles 50 Hz

| Vortex Impeller  | Code | Version | | P2 | | Max A | Flow | | Ø solids | DNM | Dimensions (mm) | | | | Weight kg |
|---|----------|---------|---------------|------|------|----------|-----------------|---------------|-------------|-----|-----------------|----|-----|-----|--------------|
| | | | | hp | kW | | l/min | m | | | A | B | C | D | |
| SEMISOM 290 HS | SM2900 | 230 V | 1-phase | 0,75 | 0,55 | 4,2 | 100 - 200 - 400 | 7 - 5,5 - 1 | 50 | 2" | 440 | 65 | 198 | 162 | 14,4 |
| | SM290+G0 | 230 V | 1-phase+float | | | | | | | | | | | | 14,6 |
| | ST2900 | 400 V | 3-phase | | | | | | | | | | | | 1,7 |
| SEMISOM 390 HS | SM3900 | 230 V | 1-phase | 1 | 0,75 | 5,5 | 100 - 250 - 500 | 8,5 - 6 - 1 | 50 | 2" | 450 | 65 | 198 | 162 | 15,7 |
| | SM390+G0 | 230 V | 1-phase+float | | | | | | | | | | | | 15,9 |
| | ST3900 | 400 V | 3-phase | | | | | | | | | | | | 2,3 |
| SEMISOM 490 HS | SM4900 | 230 V | 1-phase | 1,5 | 1,1 | 7,3 | 100 - 250 - 600 | 9,5 - 7,5 - 1 | 50 | 2" | 474 | 65 | 198 | 162 | 16,5 |
| | SM490+G0 | 230 V | 1-phase+float | | | | | | | | | | | | 16,7 |
| | ST4900 | 400 V | 3-phase | | | | | | | | | | | | 2,7 |
| SEMISOM 590 HS | SM5900 | 230 V | 1-phase | 2 | 1,5 | 10,5 | 100 - 300 - 600 | 13 - 10 - 5 | 50 | 2" | 496 | 65 | 198 | 162 | 18,2 |
| | SM590+G0 | 230 V | 1-phase+float | | | | | | | | | | | | 18,4 |
| | ST5900 | 400 V | 3-phase | | | | | | | | | | | | 4,1 |



SUPPLIED WITH

10 meters power cable



Control box containing capacitor and amperometric protection (single-phase versions)

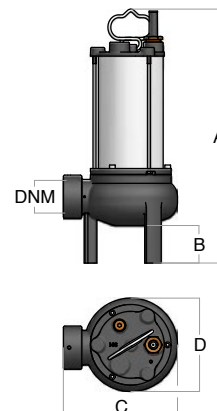
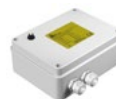

ACCESSORIES

| Code | Description |
|----------|--|
| 04105043 | Guide rail kit DNM 2" (¾" guide poles are not included) |

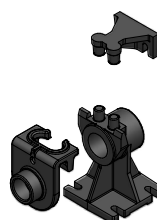

PERFORMANCE DATA 4 poles 50 Hz

| Vortex Impeller  | Code | Version | | P2 | | Max A | Flow | | Ø solids | DNM | Dimensions (mm) | | | | Weight kg |
|---|----------|---------|---------------|----|------|----------|-----------------|-------------|-------------|-----|-----------------|----|-----|-----|--------------|
| | | | | hp | kW | | l/min | m | | | A | B | C | D | |
| NEW SEMISOM 504 HS | SM5040 | 230 V | 1-phase | 1 | 0,75 | 6,1 | 100 - 300 - 500 | 6 - 4,8 - 3 | 50 | 2" | 498 | 50 | 225 | 171 | 20,2 |
| | SM504+G0 | 230 V | 1-phase+float | | | | | | | | | | | | 20,4 |
| | ST5040 | 400 V | 3-phase | | | 2,5 | | | | | | | | | 20,2 |



SUPPLIED WITH

10 meters power cable



Control box containing capacitor
and amperometric protection
(single-phase versions)

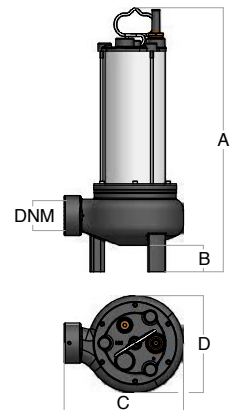

ACCESSORIES

| Code | Description |
|----------|--|
| 04105043 | Guide rail kit DNM 2" (¾" guide poles are not included) |

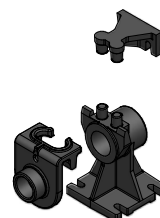

Electric submersible pumps SEMISOM series HS

for sewage water, horizontal discharge

PERFORMANCE DATA 2 poles 50 Hz

| Channel impeller  | Code | Version | | P2 | | Max A | Flow | | Ø solids | DNM | Dimensions (mm) | | | | Weight kg |
|--|----------|---------|---------------|-----|-----|----------|----------------|--------------|-------------|-----|-----------------|----|-----|-----|--------------|
| | | | | hp | kW | | l/min | m | | | A | B | C | D | |
| SEMISOM 635 HS | SM6350 | 230 V | 1-phase | 1,5 | 1,1 | 7,3 | 30 - 350 - 600 | 14,5 - 9 - 2 | 32 | 2" | 440 | 60 | 220 | 172 | 20,1 |
| | SM635+G0 | 230 V | 1-phase+float | | | | | | | | | | | | 20,3 |
| | ST6350 | 400 V | 3-phase | | | | | | | | | | | | 2,7 |



SUPPLIED WITH

10 meters power cable



Control box containing capacitor and amperometric protection (single-phase versions)

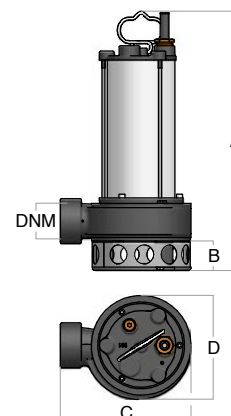

ACCESSORIES

| Code | Description |
|----------|--|
| 04105043 | Guide rail kit DNM 2" (3/4" guide poles are not included) |

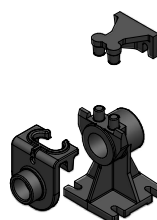
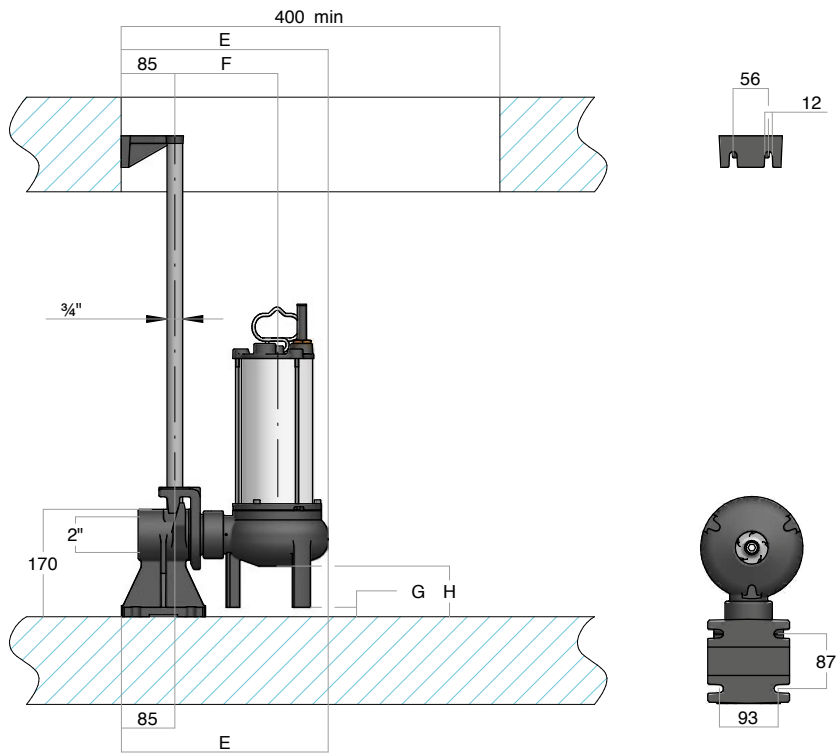

ILLUSTRATION OF AN INSTALLATION WITH GUIDE RAIL KIT



| To be installed on | Dimensions (mm) | | | |
|---------------------|-----------------|-----|----|----|
| | E | F | G | H |
| SEMISOM HS - HA | 328 | 163 | 15 | 80 |
| SEMISOM 635 HS - HA | 348 | 180 | 47 | 97 |

Electric submersible pumps SEMISOM series RS

for sewage water with rail

PERFORMANCE DATA 2 poles 50 Hz

| Vortex Impeller  | Code | Version | | P2 | | Max A | Flow | | Ø solids | DNM | Dimensions (mm) | | | | Weight kg |
|---|----------|---------|---------------|----|-----|----------|-----------------|---------------|-------------|-------|-----------------|----|-----|-----|--------------|
| | | | | hp | kW | | l/min | m | | | A | B | C | D | |
| SEMISOM 650 RS | SM650 | 230 V | 1-phase | 2 | 1,5 | 12 | 100 - 300 - 600 | 8 - 6 - 3 | 65 | 2"1/2 | 445 | 91 | 334 | 195 | 23 |
| | SM650+G | 230 V | 1-phase+float | | | | | | | | | | | | 23,3 |
| | ST650 | 400 V | 3-phase | | | | | | | | | | | | 4,6 |
| NEW SEMISOM 650H RS | SM650H | 230 V | 1-phase | 2 | 1,5 | 12 | 100 - 300 - 600 | 12 - 10,2 - 6 | 65 | 2"1/2 | 445 | 91 | 334 | 195 | 23 |
| | SM650H+G | 230 V | 1-phase+float | | | | | | | | | | | | 23,3 |
| | ST650H | 400 V | 3-phase | | | | | | | | | | | | 4,6 |

It can be installed only with guide rail kit



SUPPLIED WITH

10 meters power cable



Control box containing capacitor and amperometric protection (single-phase versions)

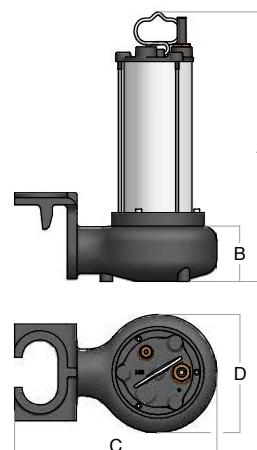
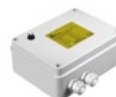

ACCESSORIES

| Code | Description |
|----------|---|
| 04105044 | Guide rail kit Semisom 650 (1"1/4 guide poles not included) |



ILLUSTRATION OF AN INSTALLATION WITH GUIDE RAIL KIT

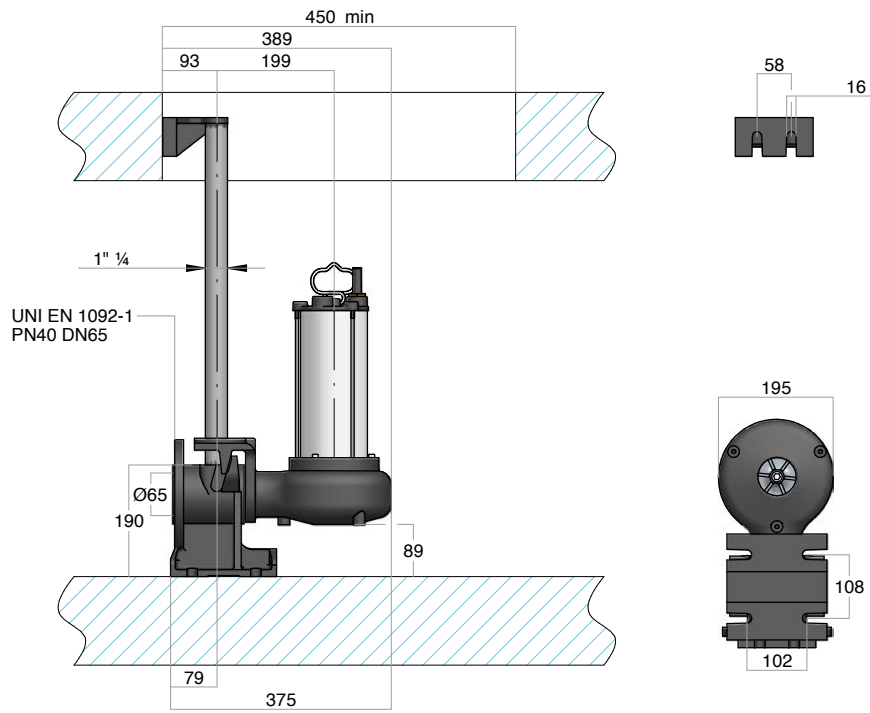

Automatic lifting station SEMIBOX

for sewage water

APPLICATION

Suitable to collect and convey waste and sewage water

Advisable if the main sewer line is at a higher level than the collecting wet well

The lifting tank can be installed inside garages, basements or underground

AVAILABLE WITH THE FOLLOWING ELECTRIC PUMPS

| Type | Construction | Characteristics / materials | Performance |
|----------------|--------------|-----------------------------|--------------|
| Semisom 125 GR | see page 127 | see page 127 | see page 128 |
| Semisom 265 VS | see page 109 | see page 109 | see page 114 |
| Semisom 265 VA | see page 109 | see page 109 | see page 112 |
| Semisom 390 VS | see page 109 | see page 109 | see page 114 |
| Semisom 390 VA | see page 109 | see page 109 | see page 112 |

CHARACTERISTICS

Tank in high-density, corrosion-resistant polyethylene for either surface or underground installation. It is supplied with all necessary gaskets to fit inlet and outlet pipes as well as the ventilation hole.

The discharge pipe has simple release fittings to disconnect the electric pump, easily

The hermetically-sealed lid can be removed for inspecting the plant

Electric pump and tank can be coupled using a \varnothing 50 mm or \varnothing 63 mm pipe

| Code | Description |
|----------|--|
| 06510026 | Automatic lifting station SEMIBOX 200 litres |

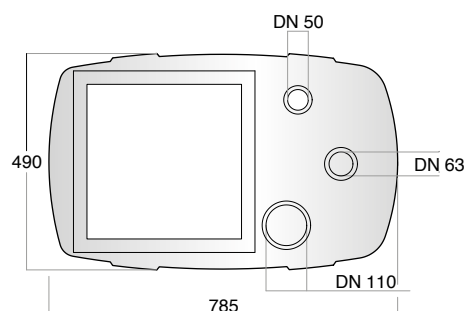
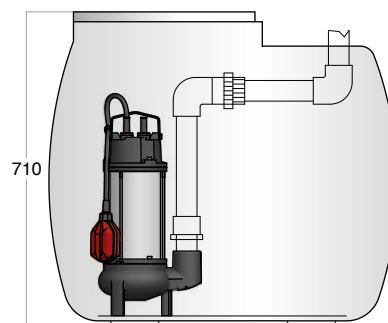

ACCESSORIES

| Code | Description |
|----------|---|
| 06520005 | Connection kit electric pump/tank DN 50/1"½ |
| 06520010 | Connection kit electric pump/tank DN 63/2" |

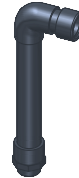

For electric pumps SEMISOM with vertical discharge

EXAMPLE OF INSTALLATION

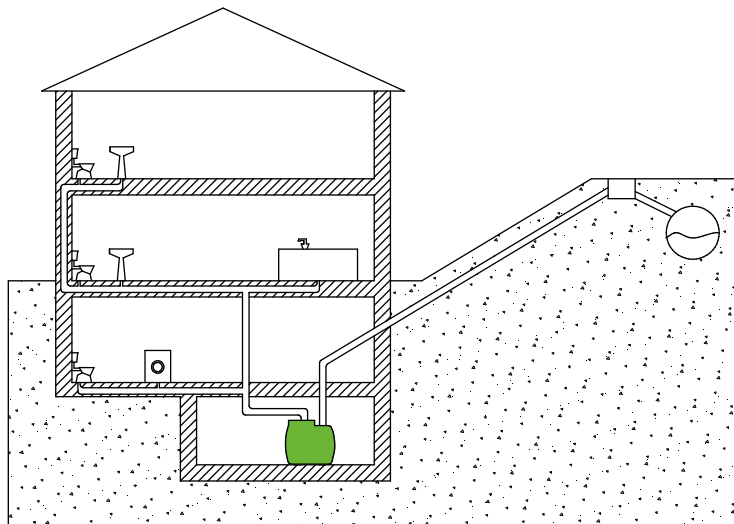

SEMISOM GR



Electric submersible pumps SEMISOM GR

for sewage water with grinder



APPLICATION

To convey waste and sewage water from septic tanks

To pump liquids containing solids and filaments, even through relative small bore pipework

CHARACTERISTICS

| | |
|--|---------------------------|
| IP rating | IP68 |
| Duty (versions 1~230V - 3~400V) | Continuous S1 |
| Maximum immersion depth (m) | 20 |
| Maximum number of starts per hour | 20 |
| Maximum temperature of the liquid pumped versions 1~230V - 3~400V (°C) | 50 |
| PH of the liquid pumped | 6 - 10 |
| Density of the liquid pumped (kg/dm ³) | <1,1 |
| Suitable for inverter drive | Three-phase versions only |

APPLICATION RANGE

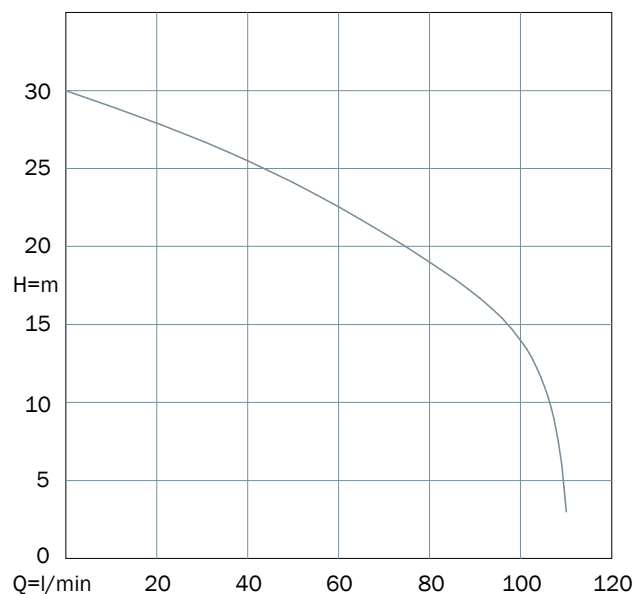

CONSTRUCTION

Coolant filled, asynchronous, rewindable electric AC motor with short circuit rotor. Insulation Class F. Windings with phase insulators to protect the motor from power peaks, as a guarantee of a highly-trustworthy product.

Resin-insulated cable kit to prevent penetration of water inside the motor

Shafts machined on ball bearings and mechanical seals location

Double mechanical seal with oil-chamber in-between

Grinder in forged and tempered stainless steel as a guarantee of high resistance

MATERIALS

| | |
|--|--|
| Tie rods, handle, motor casing, bolts and nuts | Stainless Steel AISI304 |
| Shaft | Stainless Steel AISI420B |
| Cover and volute | Mechanical cast iron EN GJL-250 |
| Impeller | Tecnopolymer reinforced with fibre-glass |
| Grinder | Forged and tempered Stainless steel AISI440C |
| Mechanical seal | Silicon carbide and alumina |
| Seal ring | NBR rubber |
| Elastomers | NBR rubber |
| Cable | Neoprene H07RN8-F |

Electric submersible pumps SEMISOM GR

for sewage water with grinder

PERFORMANCE DATA 2 poles 50 Hz

| Grinder  | Code | Version | | P2 | | Max | µF | DNM | Q m ³ /h l/min | Flow | | | | | | Dimensions (mm) | | | | Weight kg | |
|---|----------|---------|---------------|-----|------|-----|----|-----|---------------------------------|------|------|------|------|-----|-----|-----------------|-----|----|-----|--------------|------|
| | | | | hp | kW | A | | | | 0 | 1,2 | 2,4 | 3,6 | 4,8 | 6 | 6,6 | A | B | C | | D |
| | | | | | | | | | | 0 | 20 | 40 | 60 | 80 | 100 | 110 | | | | | |
| SEMISOM 125 GR (no stands) | SM125 | 230 V | 1-phase | 1,6 | 1,18 | 9,2 | 35 | 1"½ | H (m) | 30 | 27,5 | 25,5 | 22,5 | 19 | 14 | 3 | 416 | 29 | 240 | 190 | 22 |
| | SM125+G | 230 V | 1-phase+float | | | 2,9 | | | | | | | | | | | | | | | 22,2 |
| | ST125 | 400 V | 3-phase | | | 2,9 | | | | | | | | | | | | | | | 21,2 |
| SEMISOM 125 GR (with stands) | SM125P | 230 V | 1-phase | 1,6 | 1,18 | 9,2 | 35 | 1"½ | H (m) | 30 | 27,5 | 25,5 | 22,5 | 19 | 14 | 3 | 441 | 54 | 240 | 190 | 22,1 |
| | SM125+GP | 230 V | 1-phase+float | | | 2,9 | | | | | | | | | | | | | | | 22,3 |
| | ST125P | 400 V | 3-phase | | | 2,9 | | | | | | | | | | | | | | | 21,3 |



SUPPLIED WITH



10 meters power cable

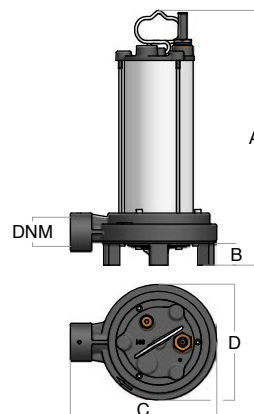

Junction box containing starting capacitor, unipolar thermal protector switch and facility to connect an extra 50 µF start-run capacitor (single-phase versions)

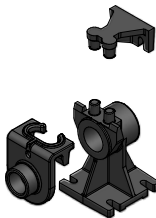

ACCESSORIES

| Code | Description | |
|----------|---|--|
| 02410016 | 90° zinc-plated elbow 1"½ M/F (to connect to the lifting station Semibox) |  |
| 02008200 | Start-run capacitor 50 µF |  |
| 04105042 | Guide rail kit DNM 1"½ (¾" guide poles not included) |  |

PERFORMANCE CURVES - 2 poles 50 Hz

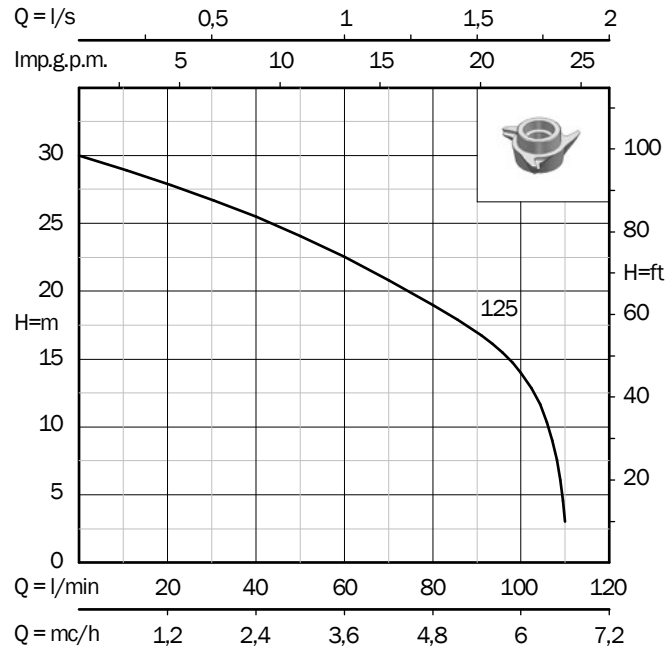
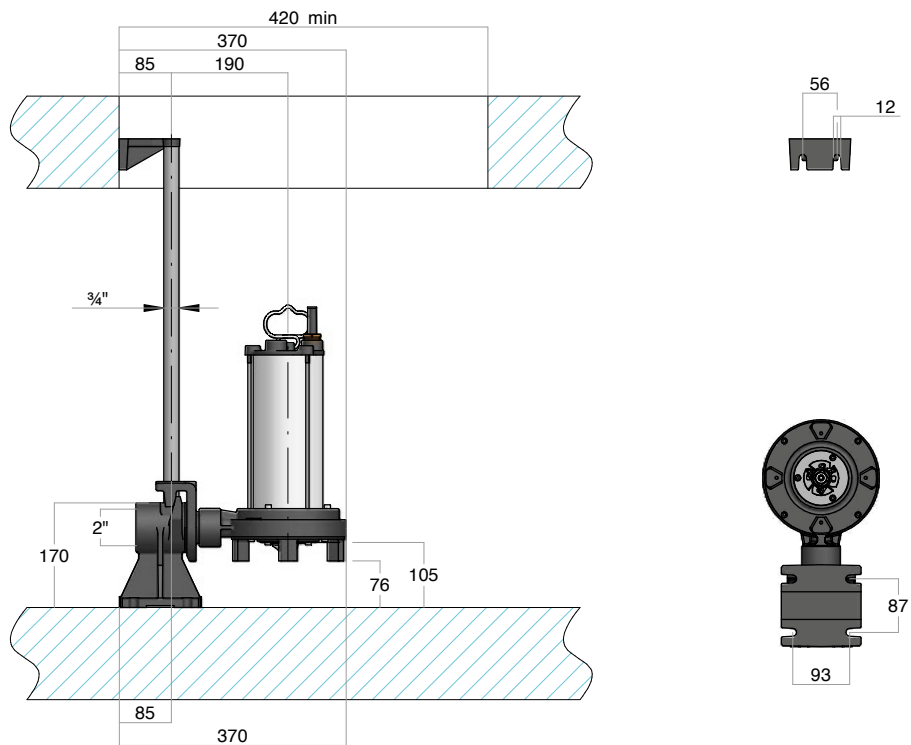

ILLUSTRATION OF AN INSTALLATION WITH GUIDE RAIL KIT



SEMISOM /50 - /65



Electric submersible pumps SEMISOM /50 - /65 for sewage water



APPLICATION

To expel rainwater, to convey waste and sewage water from sewage tanks

To pump liquids containing solids (Vortex or Double-channel impeller) and filaments (Double-channel impeller)

To pump sewage keeping its biological process unchanged (Semisom 754/65 4 poles)

CHARACTERISTICS

| | |
|--|---------------------------|
| IP rating | IP68 |
| Duty | Continuous S1 |
| Maximum immersion depth (m) | 20 |
| Maximum number of starts per hour | 30 |
| Maximum temperature of the liquid pumped (°C) | 50 |
| PH of the liquid pumped | 6 - 10 |
| Density of the liquid pumped (kg/dm ³) | <1,1 |
| Suitable for inverter drive | Only three-phase versions |

APPLICATION RANGE

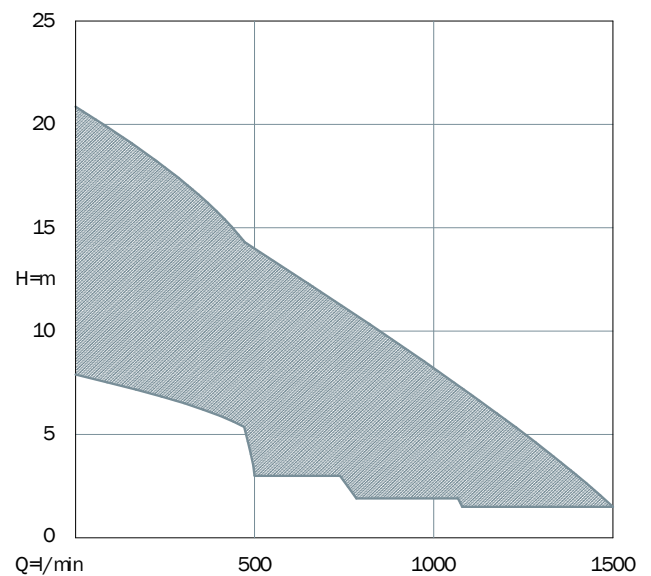

CONSTRUCTION

Coolant filled, asynchronous, rewindable electric AC motor with short circuit rotor. Insulation Class F. Windings with phase insulators to protect the motor from power peaks, as a guarantee of a highly-trustworthy product.

Resin-insulated cable kit to prevent penetration of water inside the motor

Shafts machined on ball bearings and mechanical seals location

Double mechanical seal with oil-chamber in-between

MATERIALS

| | |
|--|---------------------------------|
| Tie rods, handle, motor casing, bolts and nuts | Stainless Steel AISI304 |
| Shaft | Stainless Steel AISI420B |
| Cover and volute | Mechanical cast iron EN GJL-250 |
| Impeller | Mechanical cast iron EN GJL-200 |
| Mechanical seal | Silicon carbide and alumina |
| Seal ring | NBR rubber |
| Elastomers | NBR rubber |
| Cable | Neoprene H07RN8-F |

Electric submersible pumps SEMISOM /50 - /65

for sewage water

PERFORMANCE DATA

| Vortex Impeller | | P2 | | 1~230 V | | 3~400 V | | Poles | DNM | Solid Passage ø | Q | | Flow | | | | | | | | | | | | | | | | | | | | | | | | | | | | | |
|--|--|-----------------|-----|---------|------|---------|-------------------|-------|-----|-----------------|-------|-------|------|------|-----|------|-----|-----|-----|-----|-----|------|------|------|------|--|--|--|--|--|--|--|--|--|--|--|--|--|--|--|--|--|
| | | hp | kW | Max A | μF | Max A | m ³ /h | | | | 0 | 12 | 18 | 24 | 30 | 36 | 42 | 48 | 54 | 60 | 66 | 78 | 90 | | | | | | | | | | | | | | | | | | | |
| | | | | | | | | | | | | l/min | 0 | 200 | 300 | 400 | 500 | 600 | 700 | 800 | 900 | 1000 | 1100 | 1300 | 1500 | | | | | | | | | | | | | | | | | |
|  | | SEMISOM 500/50 | 1,5 | 1,1 | 9,2 | 40 | 3,3 | 2 | 2" | 50 | H (m) | 10 | 8,5 | 7,5 | 6 | 3 | | | | | | | | | | | | | | | | | | | | | | | | | | |
| | | SEMISOM 800/50 | 2 | 1,5 | 11,4 | 45 | 4 | 2 | 2"½ | 50 | | 11,5 | 10 | 9,5 | 8,5 | 7 | 4 | | | | | | | | | | | | | | | | | | | | | | | | | |
| | | SEMISOM 1100/65 | 3 | 2,2 | | | 6 | 2 | 3" | 65 | | 13 | 11 | 9,5 | 8,5 | 7 | 5,5 | 4 | 2,5 | 1 | | | | | | | | | | | | | | | | | | | | | | |
| | | SEMISOM 1300/65 | 4,5 | 3,4 | | | 8,1 | 2 | 3" | 65 | | 18,5 | 16 | 14,5 | 13 | 11,5 | 10 | 8,5 | 7 | 5,5 | 3,5 | 2 | | | | | | | | | | | | | | | | | | | | |
| | | SEMISOM 754/65 | 1,6 | 1,2 | 7,7 | 31,5 | 3,3 | 4 | 3" | 65 | | 7,8 | 6,7 | 6,2 | 5,5 | 4,6 | 3,7 | 2,5 | | | | | | | | | | | | | | | | | | | | | | | | |

| Channel Impeller | | P2 | | 1~230 V | | 3~400 V | | Poles | DNM | Solid Passage ø | Q | | Flow | | | | | | | | | | | | | | | | | | | | | | | | | | | | | | |
|--|--|-----------------|-----|---------|------|---------|-------------------|-------|-----|-----------------|-------|-------|------|------|------|------|------|------|-----|-----|-----|------|------|------|------|--|--|--|--|--|--|--|--|--|--|--|--|--|--|--|--|--|--|
| | | hp | kW | Max A | μF | Max A | m ³ /h | | | | 0 | 12 | 18 | 24 | 30 | 36 | 42 | 48 | 54 | 60 | 66 | 78 | 90 | | | | | | | | | | | | | | | | | | | | |
| | | | | | | | | | | | | l/min | 0 | 200 | 300 | 400 | 500 | 600 | 700 | 800 | 900 | 1000 | 1100 | 1300 | 1500 | | | | | | | | | | | | | | | | | | |
|  | | SEMISOM 700/50 | 1,5 | 1,1 | 9,2 | 40 | 3,3 | 2 | 2" | 50 | H (m) | 14 | 11,5 | 10 | 8,5 | 7 | 5 | 3 | 1 | | | | | | | | | | | | | | | | | | | | | | | | |
| | | SEMISOM 900/50 | 2 | 1,5 | 11,4 | 45 | 4 | 2 | 2"½ | 50 | | 16 | 14 | 12,5 | 11,5 | 10 | 8 | 6,5 | 5 | 3 | 0,5 | | | | | | | | | | | | | | | | | | | | | | |
| | | SEMISOM 1000/50 | 3 | 2,2 | | | 5,9 | 2 | 2"½ | 50 | | 20,5 | 18 | 17 | 15,5 | 14 | 12 | 10,5 | 8,5 | 6 | 4 | 1,5 | | | | | | | | | | | | | | | | | | | | | |
| | | SEMISOM 1500/65 | 4,5 | 3,4 | | | 9 | 2 | 3" | 65 | | 19,5 | 17,5 | 16,5 | 15,5 | 14,5 | 13,5 | 12 | 11 | 10 | 8,5 | 7 | 4,5 | 1,5 | | | | | | | | | | | | | | | | | | | |

PERFORMANCE CURVES

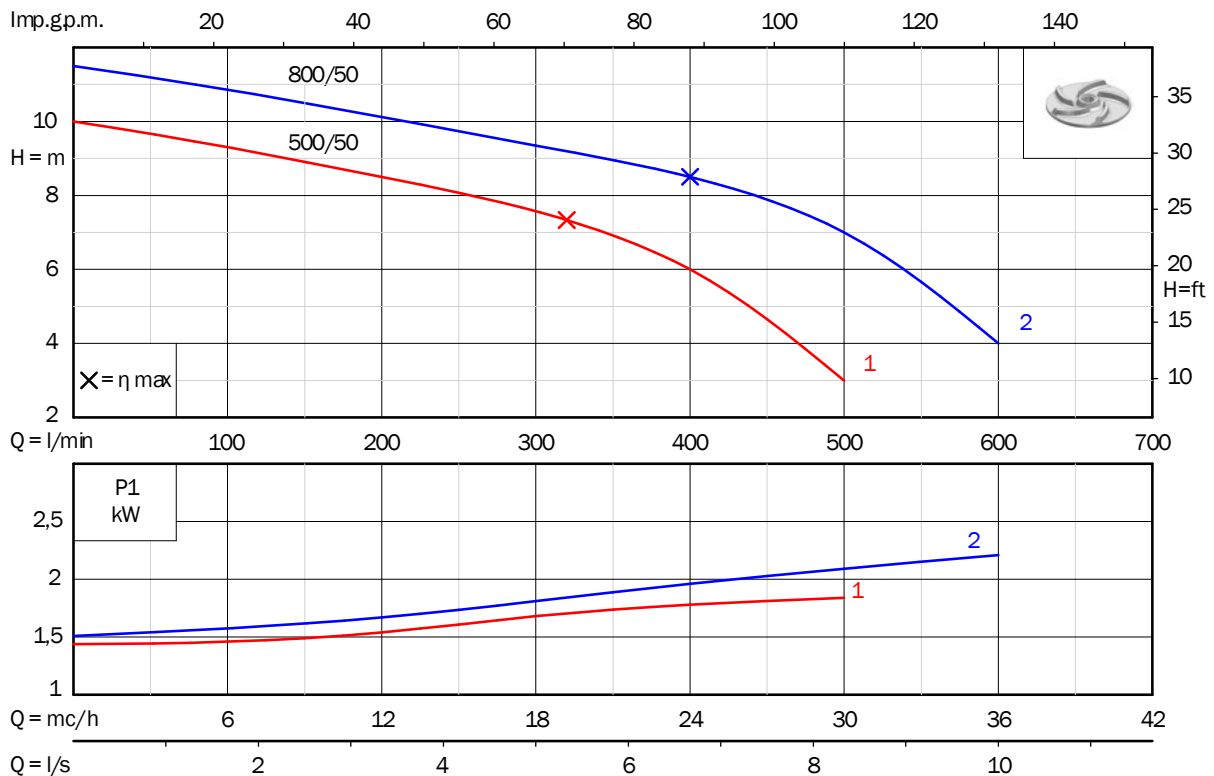

PERFORMANCE CURVES

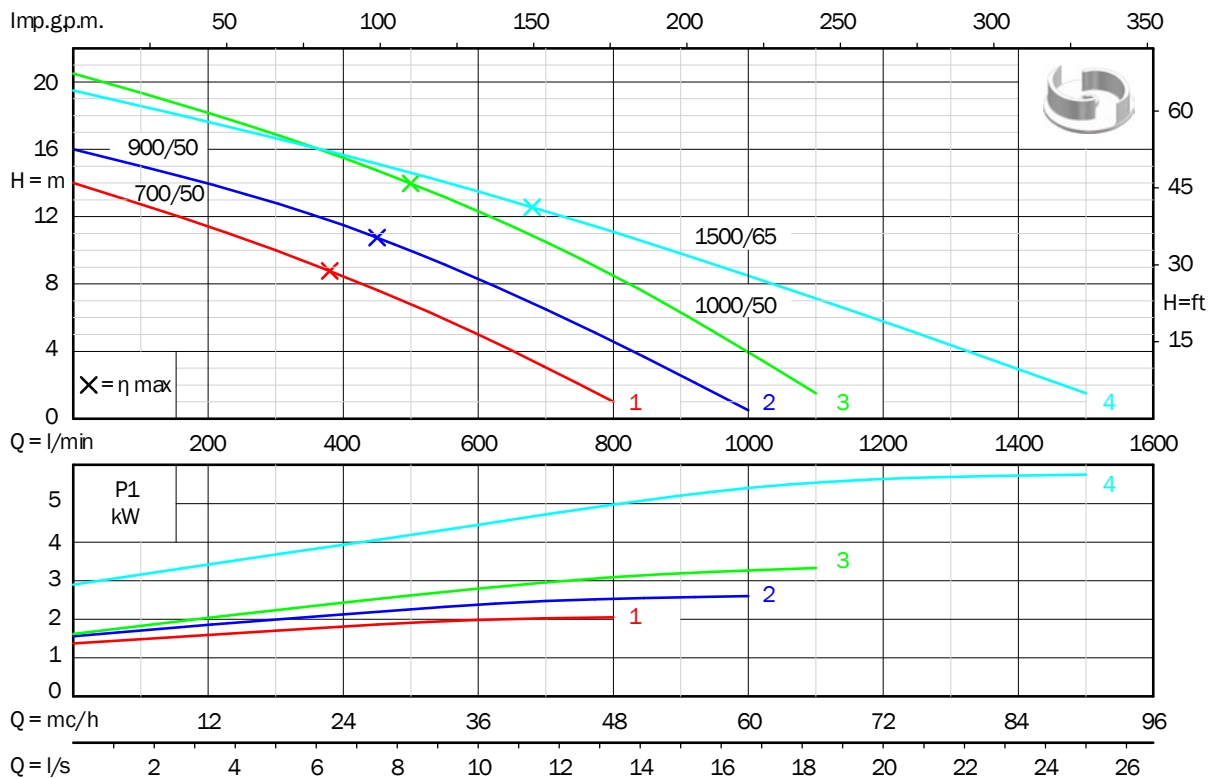
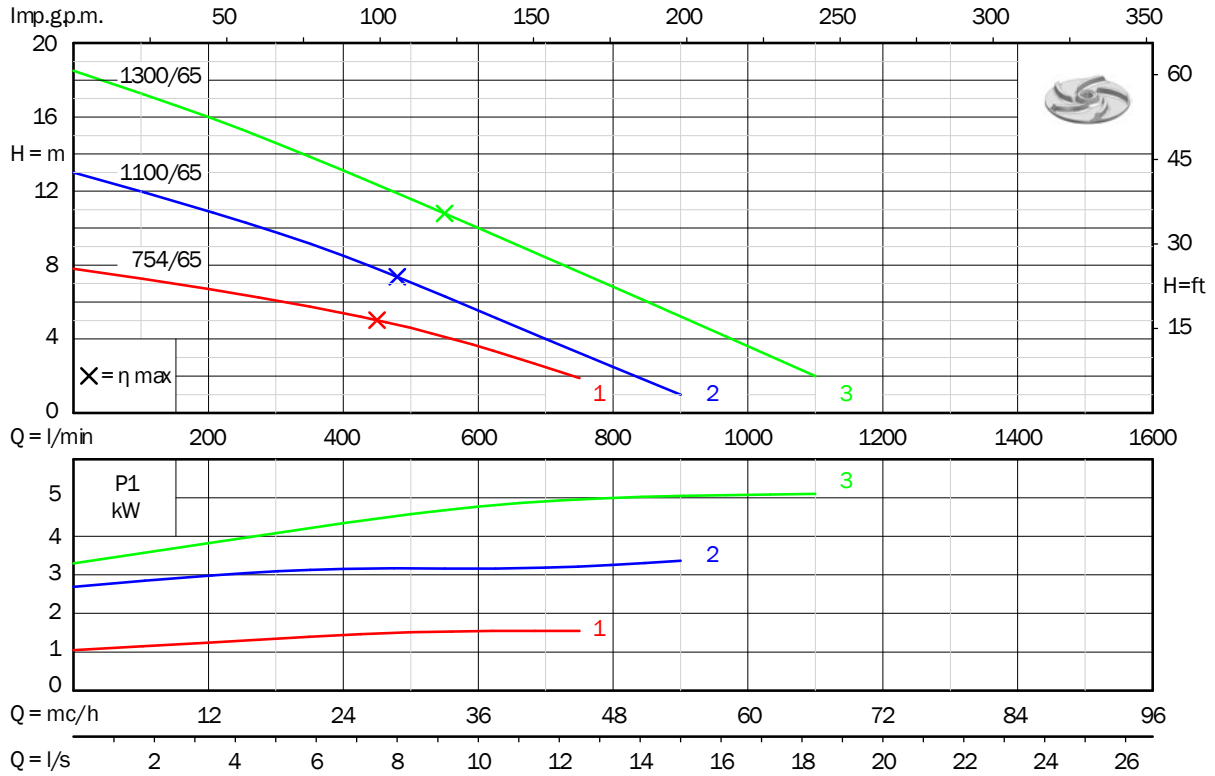

Electric submersible pumps SEMISOM /50

for sewage water

PERFORMANCE DATA 2 poles 50 Hz

| Vortex Impeller  | Code | Version | | P2 | | P1 | | Max | Flow | | Ø solids | DNM | Dimensions (mm) | | | | Weight |
|---|---------------|---------|---------------|-----|------|------|------|-----------------|---------------|----|----------|-----|-----------------|-----|-----|------|--------|
| | | | | hp | kW | kW | A | | l/min | m | | | A | B | C | D | |
| SEMISOM 500/50 | SM/50/500/1 | 230 V | 1-phase | 1,5 | 1,1 | 1,84 | 9,2 | 100 - 300 - 500 | 9,5 - 7,5 - 3 | 50 | 2" | 518 | 70 | 354 | 254 | 32 | |
| | SM/50/500+G/1 | 230 V | 1-phase+float | | | 1,63 | 3,3 | | | | | | | | | 32,3 | |
| | ST/50/500/1 | 400 V | 3-phase | 508 | 30,5 | | | | | | | | | | | | |
| SEMISOM 800/50 | SM/50/800/1 | 230 V | 1-phase | 2 | 1,5 | 2,21 | 11,4 | 100 - 300 - 600 | 11 - 9,5 - 4 | 50 | 2"½ | 543 | 70 | 362 | 254 | 34,5 | |
| | SM/50/800+G/1 | 230 V | 1-phase+float | | | 2,07 | 4 | | | | | | | | | 34,8 | |
| | ST/50/800/1 | 400 V | 3-phase | | | 508 | 31 | | | | | | | | | | |

P1: Max. absorbed power - P2: Nominal power of the motor

PERFORMANCE DATA 2 poles 50 Hz

| Channel impeller  | Code | Version | | P2 | | P1 | | Max | Flow | | Ø solids | DNM | Dimensions (mm) | | | | Weight |
|--|---------------|---------|---------------|-----|-----|------|------|------------------|-----------------|----|----------|-----|-----------------|-----|-----|------|--------|
| | | | | hp | kW | kW | A | | l/min | m | | | A | B | C | D | |
| SEMISOM 700/50 | SM/50/700/1 | 230 V | 1-phase | 1,5 | 1,1 | 2,05 | 9,2 | 100 - 400 - 800 | 13 - 8,5 - 1 | 50 | 2" | 518 | 70 | 354 | 254 | 32,5 | |
| | SM/50/700+G/1 | 230 V | 1-phase+float | | | 1,93 | 3,3 | | | | | | | | | 32,8 | |
| | ST/50/700/1 | 400 V | 3-phase | 508 | 31 | | | | | | | | | | | | |
| SEMISOM 900/50 | SM/50/900/1 | 230 V | 1-phase | 2 | 1,5 | 2,6 | 11,4 | 100 - 500 - 1000 | 15 - 10 - 0,5 | 50 | 2"½ | 543 | 70 | 362 | 254 | 35 | |
| | SM/50/900+G/1 | 230 V | 1-phase+float | | | 2,39 | 4 | | | | | | | | | 35,3 | |
| | ST/50/900/1 | 400 V | 3-phase | | | 508 | 31 | | | | | | | | | | |
| SEMISOM 1000/50 | ST/50/1000/1 | 400 V | 3-phase | 3 | 2,2 | 3,33 | 5,9 | 100 - 500 - 1100 | 19,5 - 14 - 1,5 | 50 | 2"½ | 543 | 70 | 362 | 254 | 35 | |

P1: Max. absorbed power - P2: Nominal power of the motor

SUPPLIED WITH

10 meters power cable



Control box containing capacitor and illuminated thermal protector switch (single-phase versions)



OPTIONS

Version with thermic probe so to protect the motor from overheating (to be wired to protection/control panel type QT-MT - AM-AT)

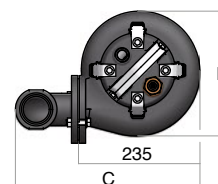
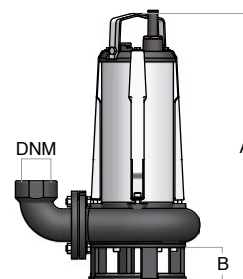

ACCESSORIES

| Code | Description |
|----------|--|
| 04105046 | Guide rail kit /50 (1"¼ guide poles not included) |

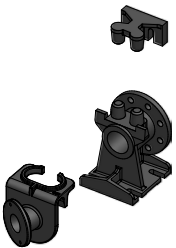
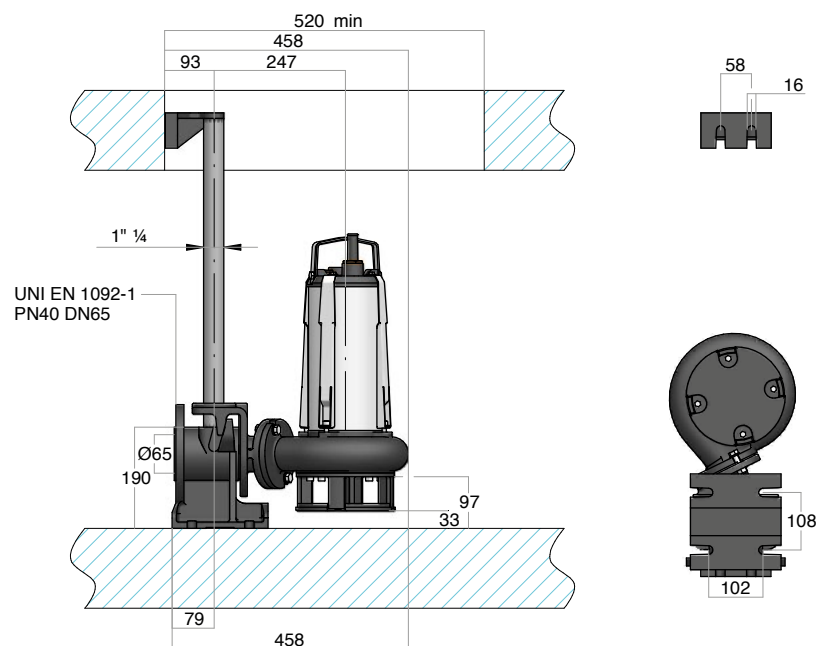



ILLUSTRATION OF AN INSTALLATION WITH GUIDE RAIL KIT



Electric submersible pumps SEMISOM /65

for sewage water

PERFORMANCE DATA 2 poles 50 Hz

| Vortex Impeller  | Code | Version | | P2 | | P1 | Max | Flow | | Ø solids | DNM | Dimensions (mm) | | | | Weight kg |
|---|--------------|---------|---------|-----|-----|------|-----|------------------|-------------|----------|-----|-----------------|----|-----|-----|--------------|
| | | | | hp | kW | kW | A | l/min | m | | | A | B | C | D | |
| SEMISOM 1100/65 | ST/65/1100/1 | 400 V | 3-phase | 3 | 2,2 | 3,37 | 6 | 100 - 500 - 900 | 12 - 7 - 1 | 65 | 3" | 584 | 65 | 417 | 222 | 40 |
| SEMISOM 1300/65 | ST/65/1300/1 | 400 V | 3-phase | 4,5 | 3,4 | 5,1 | 8,1 | 100 - 600 - 1100 | 17 - 10 - 2 | 65 | 3" | 609 | 65 | 417 | 222 | 42,5 |

P1: Max. absorbed power - P2: Nominal power of the motor

PERFORMANCE DATA 4 poles 50 Hz

| Vortex Impeller  | Code | Version | | P2 | | P1 | Max | Flow | | Ø solids | DNM | Dimensions (mm) | | | | Weight kg |
|---|---------------|---------|---------------|-----|-----|------|-----|-----------------|-----------------|----------|-----|-----------------|----|-----|-----|--------------|
| | | | | hp | kW | kW | A | l/min | m | | | A | B | C | D | |
| SEMISOM 754/65 | SM/65/754/1 | 230 V | 1-phase | 1,6 | 1,2 | 1,55 | 7,7 | 100 - 400 - 750 | 7,3 - 5,5 - 1,9 | 65 | 3" | 569 | 65 | 417 | 222 | 38,5 |
| | SM/65/754+G/1 | 230 V | 1-phase+float | | | | | | | | | | | | | 38,8 |
| | ST/65/754/1 | 400 V | 3-phase | | | | | | | | | | | | | 1,45 |

P1: Max. absorbed power - P2: Nominal power of the motor

PERFORMANCE DATA 2 poles 50 Hz

| Channel impeller  | Code | Version | | P2 | | P1 | Max | Flow | | Ø solids | DNM | Dimensions (mm) | | | | Weight kg |
|--|--------------|---------|---------|-----|-----|------|-----|------------------|-----------------|----------|-----|-----------------|----|-----|-----|--------------|
| | | | | hp | kW | kW | A | l/min | m | | | A | B | C | D | |
| SEMISOM 1500/65 | ST/65/1500/1 | 400 V | 3-phase | 4,5 | 3,4 | 5,75 | 9 | 100 - 700 - 1500 | 18,5 - 12 - 1,5 | 65 | 3" | 609 | 65 | 417 | 222 | 44 |

P1: Max. absorbed power - P2: Nominal power of the motor



SUPPLIED WITH

10 meters power cable



Control box containing capacitor and illuminated thermal protector switch (single-phase versions)



OPTIONS

Version with thermic probe so to protect the motor from overheating (to be wired to protection/control panel type QT-MT - AM-AT)

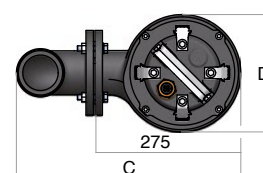
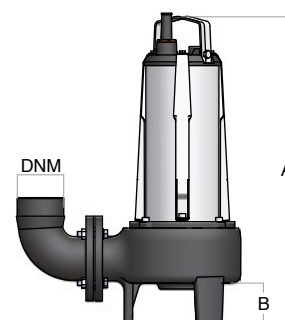

ACCESSORIES

| Code | Description |
|----------|--|
| 04105052 | Guide rail kit /65 (1"¼ guide poles not included) |

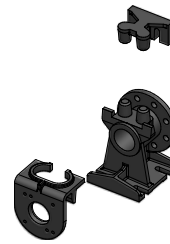
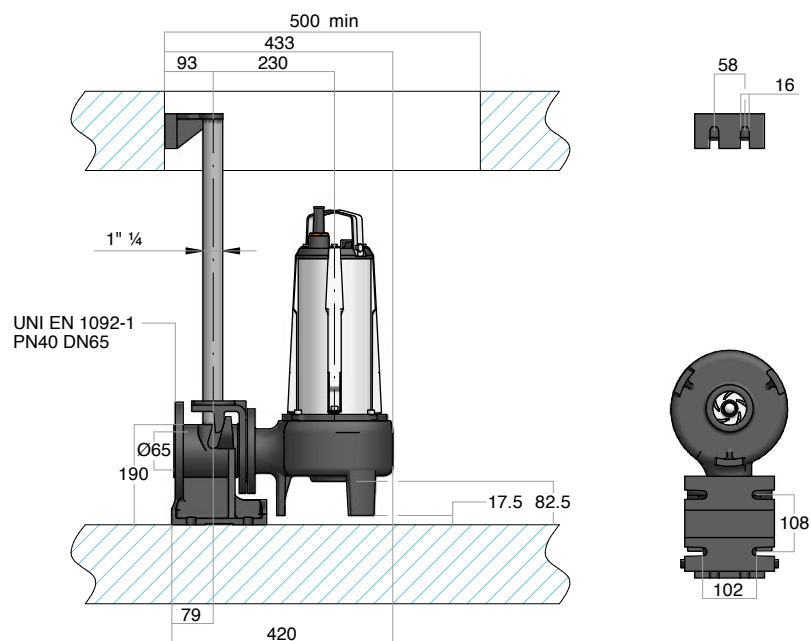

ILLUSTRATION OF AN INSTALLATION WITH GUIDE RAIL KIT



SEMISOM /80



Electric submersible pumps SEMISOM /80 for sewage water



APPLICATION

To expel rainwater, to convey waste and sewage water from sewage tanks

To pump liquids containing solids (Vortex or Double-channel impeller) and filaments (Double-channel impeller)

To pump sewage keeping its biological process unchanged (Semisom 1504/80 4 poles)

CHARACTERISTICS

| | |
|--|---------------|
| IP rating | IP68 |
| Duty | Continuous S1 |
| Maximum immersion depth (m) | 20 |
| Maximum number of starts per hour | 30 |
| Maximum temperature of the liquid pumped (°C) | 50 |
| PH of the liquid pumped | 6 - 10 |
| Density of the liquid pumped (kg/dm ³) | <1,1 |
| Suitable for inverter drive | Yes |

APPLICATION RANGE

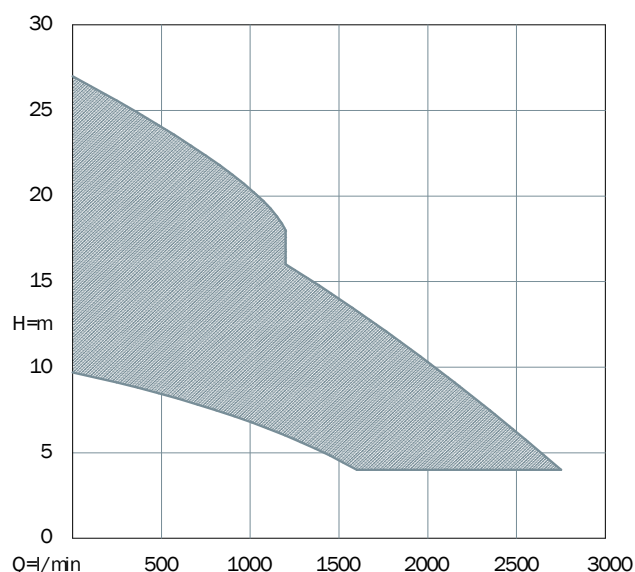

CONSTRUCTION

Three-phase, asynchronous. Coolant-filled electric rewindable motor with short circuit rotor. Insulation class F. Winding with phase insulators to protect the motor from power peaks, as a guarantee of a highly reliable product.

Micro thermostat to protect the motor from overheating to be wired to the protection/control panel

Probe to detect water ingress in the oil chamber between the two mechanical seals to be wired to the protection/control panel

Resin-insulated cable kit to prevent penetration of water inside the motor

Shafts machined on ball bearings and mechanical seals location

Double mechanical seals with oil chamber in-between

MATERIALS

| | |
|--|---------------------------------|
| Tie rods, handle, motor casing, bolts and nuts | Stainless Steel AISI304 |
| Shaft | Stainless Steel AISI420B |
| Cover and volute | Mechanical cast iron EN GJL-250 |
| Impeller | Mechanical cast iron EN GJL-200 |
| Feet | Stainless Steel AISI304 |
| Lower mechanical seal | Silicon carbide and alumina |
| Upper mechanical seal | Graphite and Alumina |
| Elastomers | NBR rubber |
| Cable | PBS8-F AD8 |

Electric submersible pumps SEMISOM /80

for sewage water

PERFORMANCE DATA

| Vortex Impeller | P2 | | 3~400 V | | Poles | DNM | Solid Passage \varnothing | Q | | Flow | | | | | | | | | | | | | | |
|--|-----|-----|---------|-------------------|-------|-----|-----------------------------|-------|------|------|------|------|------|------|------|-----|-----|-----|-----|-----|-----|-----|--|--|
| | hp | kW | Max A | m ³ /h | | | | l/min | 0 | 15 | 30 | 45 | 60 | 72 | 78 | 90 | 96 | 108 | 123 | 135 | 150 | 165 | | |
| | | | | | | | | | | | | | | | | | | | | | | | | |
|  | | | | | | | | | | | | | | | | | | | | | | | | |
| SEMISOM 1504/80 | 3,5 | 2,6 | 8,2 | 4 | 80 | 74 | H (m) | 9,7 | 9 | 8,6 | 7,8 | 6,8 | 5,8 | 5,4 | 4,4 | 3,9 | | | | | | | | |
| SEMISOM 1555/80 | 5,5 | 4 | 9,2 | 2 | 80 | 74 | | 14 | 13,5 | 12,6 | 11,1 | 8,2 | 6,3 | 5,5 | 4 | | | | | | | | | |
| SEMISOM 1255/80 | 5,5 | 4 | 9,1 | 2 | 80 | 74 | | 15,5 | 14,6 | 13,7 | 12,4 | 9,7 | 7,7 | | | | | | | | | | | |
| SEMISOM 1055/80 | 5,5 | 4 | 9,2 | 2 | 80 | 74 | | 17 | 16,4 | 15,5 | 14,1 | 11,4 | | | | | | | | | | | | |
| SEMISOM 1775/80 | 7,5 | 5,5 | 11,9 | 2 | 80 | 74 | | 17 | 16,4 | 15,5 | 14,1 | 11,4 | 9,1 | 8,1 | 6,5 | 5,7 | 4,4 | | | | | | | |
| SEMISOM 1675/80 | 7,5 | 5,5 | 12 | 2 | 80 | 74 | | 19 | 18,2 | 17,2 | 16 | 13,7 | 11,1 | 9,9 | 8,1 | 7,4 | | | | | | | | |
| SEMISOM 1375/80 | 7,5 | 5,5 | 11,9 | 2 | 80 | 74 | | 21 | 20 | 18,5 | 17,2 | 15 | 12,7 | 11,6 | | | | | | | | | | |
| SEMISOM 2100/80 | 10 | 7,5 | 16,2 | 2 | 80 | 74 | | 21 | 20 | 18,5 | 17,2 | 15 | 12,7 | 11,6 | 9,6 | 8,7 | 6,7 | 4 | | | | | | |
| SEMISOM 1600/80 | 10 | 7,5 | 16,2 | 2 | 80 | 74 | | 24 | 23 | 21,7 | 20,3 | 18,3 | 16,1 | 14,9 | 12,6 | | | | | | | | | |
| SEMISOM 1200/80 | 10 | 7,5 | 16,4 | 2 | 80 | 74 | | 27 | 25,4 | 23,8 | 22,4 | 20,4 | 18 | | | | | | | | | | | |

| Channel impeller | P2 | | 3~400 V | | Poles | DNM | Solid Passage \varnothing | Q | | Flow | | | | | | | | | | | | | |
|---|----|----|---------|-------------------|-------|-------|-----------------------------|-------|---|------|------|----|------|------|----|------|------|------|-----|-----|-----|-----|--|
| | hp | kW | Max A | m ³ /h | | | | l/min | 0 | 15 | 30 | 45 | 60 | 72 | 78 | 90 | 96 | 108 | 123 | 135 | 150 | 165 | |
| | | | | | | | | | | | | | | | | | | | | | | | |
|  | | | | | | | | | | | | | | | | | | | | | | | |
| SEMISOM 2700/80 | 11 | 8 | 18 | 2 | 80 | 45x62 | H (m) | | | 20 | 18,5 | 17 | 15,8 | 15,3 | 14 | 13,4 | 12,1 | 10,4 | 8,7 | 6,5 | 4 | | |

PERFORMANCE CURVES

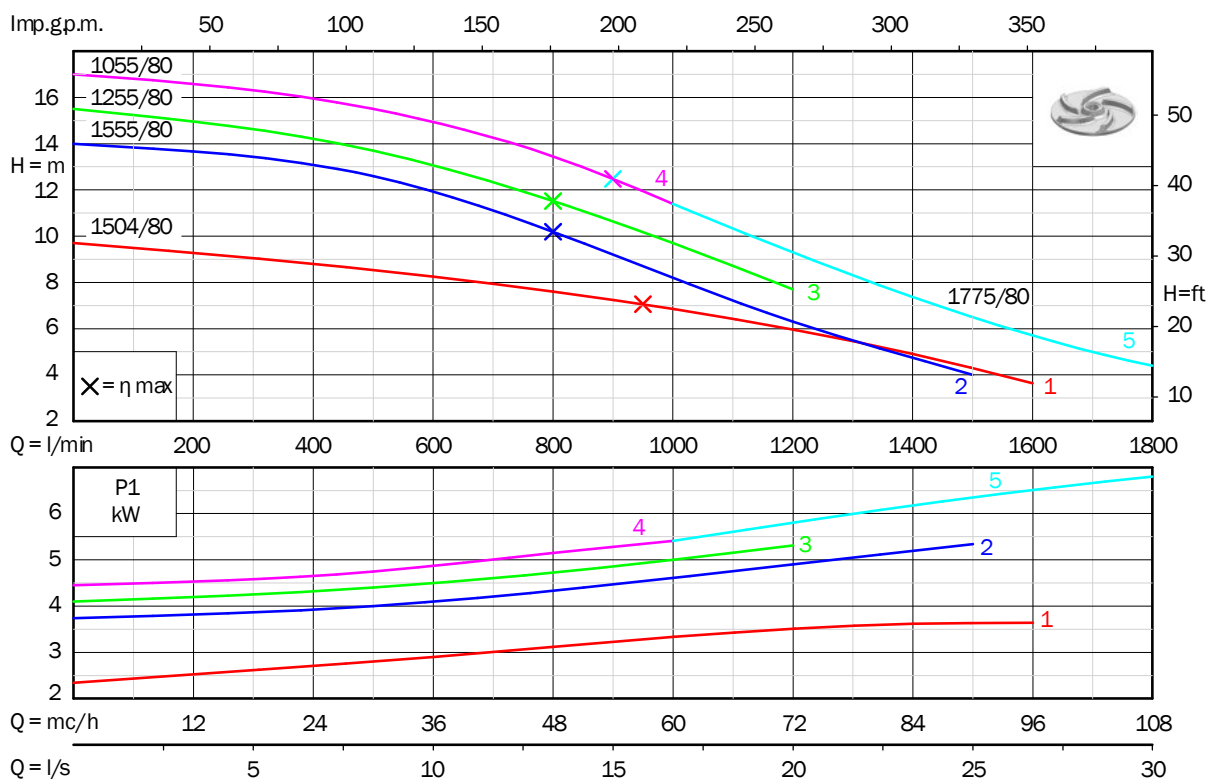

PERFORMANCE CURVES

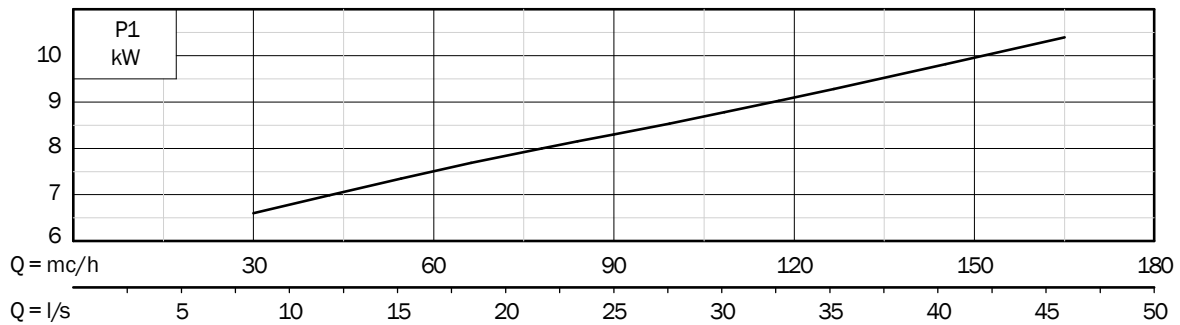
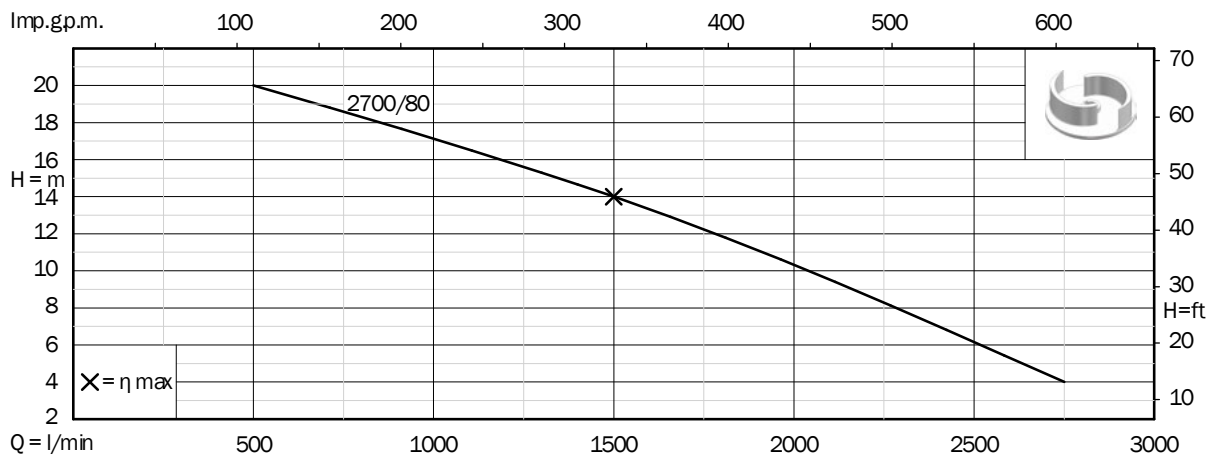
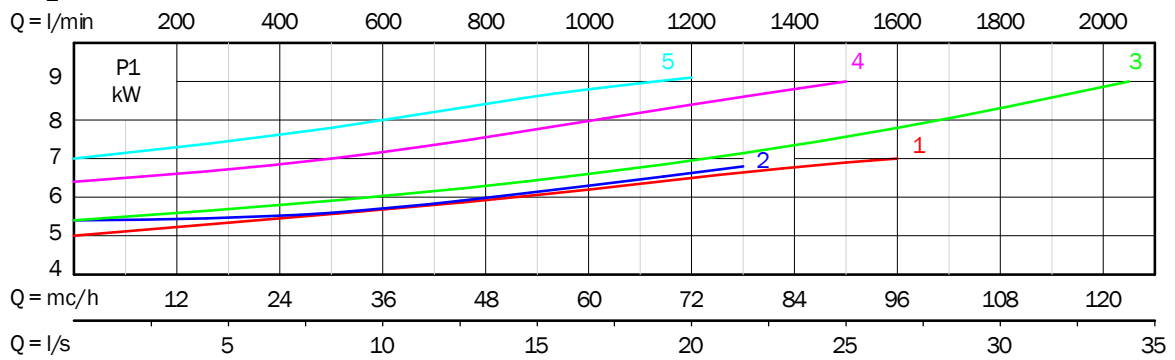
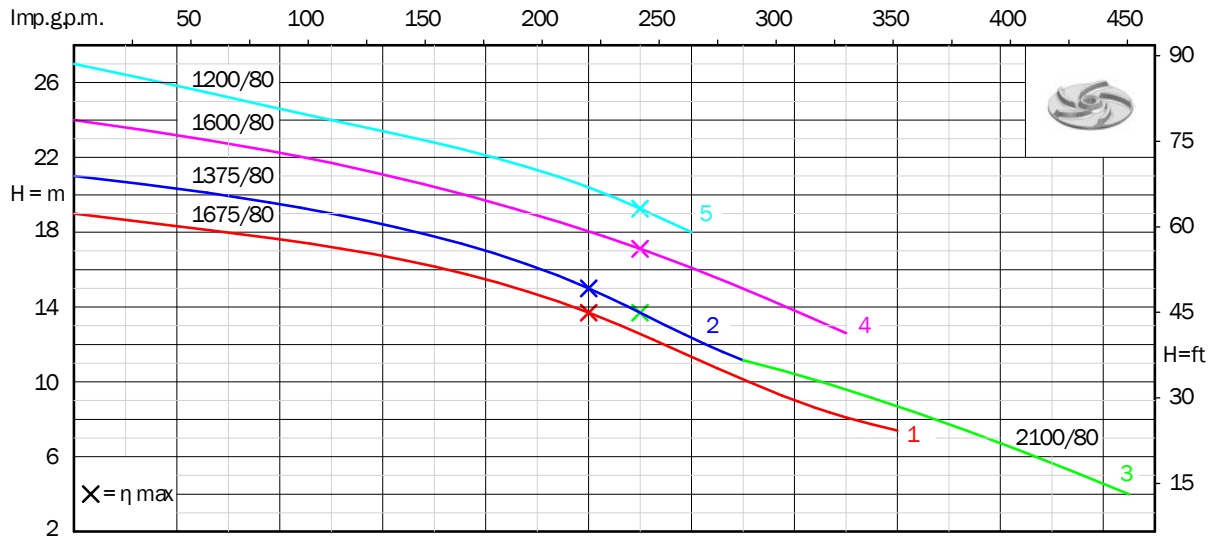

Electric submersible pumps SEMISOM /80

for sewage water

PERFORMANCE DATA - 2 poles 50 Hz

| Vortex Impeller  | Code | Version | | P2 | | P1 | Max | Flow | | Ø solids | DNM | Dimensions (mm) | | | | Weight kg |
|---|------------|---------|---------|-----|-----|------|------|-------------------|--------------------|----------|-----|-----------------|----|-----|-----|--------------|
| | | | | hp | kW | kW | A | l/min | m | | | A | B | C | D | |
| SEMISOM 1555/80 | ST/80/1555 | 400 V | 3-phase | 5,5 | 4 | 5,34 | 9,2 | 250 - 800 - 1500 | 13,5 - 10,6 - 4 | 74 | 80 | 703 | 78 | 383 | 295 | 65,5 |
| SEMISOM 1255/80 | ST/80/1255 | 400 V | 3-phase | 5,5 | 4 | 5,31 | 9,1 | 250 - 600 - 1200 | 14,6 - 13,2 - 7,7 | 74 | 80 | 703 | 78 | 383 | 295 | 65,5 |
| SEMISOM 1055/80 | ST/80/1055 | 400 V | 3-phase | 5,5 | 4 | 5,41 | 9,2 | 250 - 500 - 1000 | 16,4 - 15,5 - 11,4 | 74 | 80 | 703 | 78 | 383 | 295 | 65,5 |
| SEMISOM 1775/80 | ST/80/1775 | 400 V | 3-phase | 7,5 | 5,5 | 6,8 | 11,9 | 250 - 1200 - 1800 | 16,4 - 9,1 - 4,4 | 74 | 80 | 733 | 78 | 383 | 295 | 69 |
| SEMISOM 1675/80 | ST/80/1675 | 400 V | 3-phase | 7,5 | 5,5 | 7 | 12 | 250 - 1000 - 1600 | 18,2 - 13,7 - 7,4 | 74 | 80 | 733 | 78 | 383 | 295 | 69 |
| SEMISOM 1375/80 | ST/80/1375 | 400 V | 3-phase | 7,5 | 5,5 | 6,8 | 11,9 | 250 - 800 - 1300 | 20 - 16,8 - 11,6 | 74 | 80 | 733 | 78 | 383 | 295 | 69 |
| SEMISOM 2100/80 | ST/80/2100 | 400 V | 3-phase | 10 | 7,5 | 9 | 16,2 | 250 - 1300 - 2050 | 20 - 11,6 - 4 | 74 | 80 | 758 | 78 | 383 | 295 | 71 |
| SEMISOM 1600/80 | ST/80/1600 | 400 V | 3-phase | 10 | 7,5 | 9 | 16,2 | 250 - 1000 - 1500 | 23 - 18,3 - 12,6 | 74 | 80 | 758 | 78 | 383 | 295 | 71 |
| SEMISOM 1200/80 | ST/80/1200 | 400 V | 3-phase | 10 | 7,5 | 9,1 | 16,4 | 250 - 800 - 1200 | 25,4 - 22 - 18 | 74 | 80 | 758 | 78 | 383 | 295 | 71 |

P1: Max. absorbed power - P2: Nominal power of the motor

PERFORMANCE DATA - 4 poles 50 Hz

| Vortex Impeller  | Code | Version | | P2 | | P1 | Max | Flow | | Ø solids | DNM | Dimensions (mm) | | | | Weight kg |
|---|------------|---------|---------|-----|-----|------|-----|-------------------|-----------------|----------|-----|-----------------|----|-----|-----|--------------|
| | | | | hp | kW | kW | A | l/min | m | | | A | B | C | D | |
| SEMISOM 1504/80 | ST/80/1504 | 400 V | 3-phase | 3,5 | 2,6 | 3,64 | 8,2 | 200 - 1000 - 1600 | 9,3 - 6,8 - 3,9 | 74 | 80 | 758 | 78 | 383 | 295 | 71 |

P1: Max. absorbed power - P2: Nominal power of the motor

PERFORMANCE DATA - 2 poles 50 Hz

| Channel impeller  | Code | Version | | P2 | | P1 | Max | Flow | | Ø solids | DNM | Dimensions (mm) | | | | Weight kg |
|--|------------|---------|---------|----|----|------|-----|-------------------|-------------|----------|-----|-----------------|----|-----|-----|--------------|
| | | | | hp | kW | kW | A | l/min | m | | | A | B | C | D | |
| SEMISOM 2700/80 | ST/80/2700 | 400 V | 3-phase | 11 | 8 | 10,4 | 18 | 500 - 1500 - 2750 | 20 - 14 - 4 | 45x62 | 80 | 758 | 78 | 383 | 295 | 71 |

P1: Max. absorbed power - P2: Nominal power of the motor



SUPPLIED WITH

10 meters power cable



Micro thermostat to protect the motor from overheating to be wired to the protection/control panel (type QT-MT - AM-AT)



Humidity probe to be wired to the protection/control panel (type ATS - AT2S)

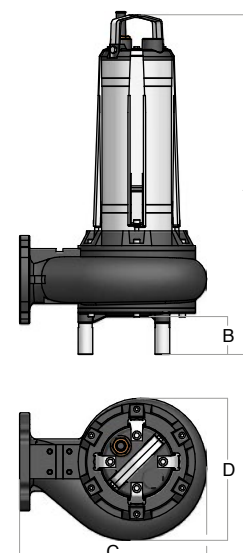

ACCESSORIES

| Code | Description |
|----------|---|
| 04105053 | Guide rail kit /80 (2" guide poles not included) |
| 04105054 | Pump stand |
| 04105049 | Threaded flange UNI EN 1092-1 |

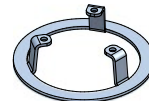
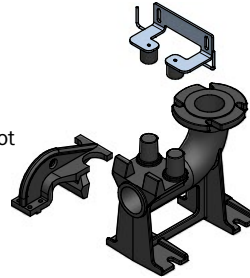
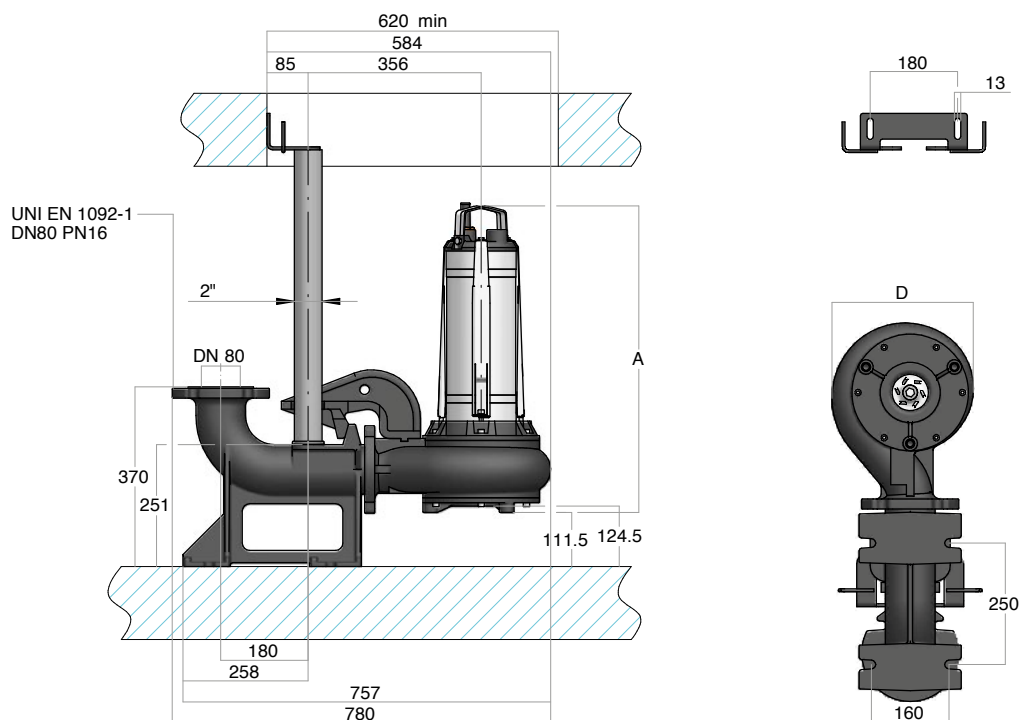
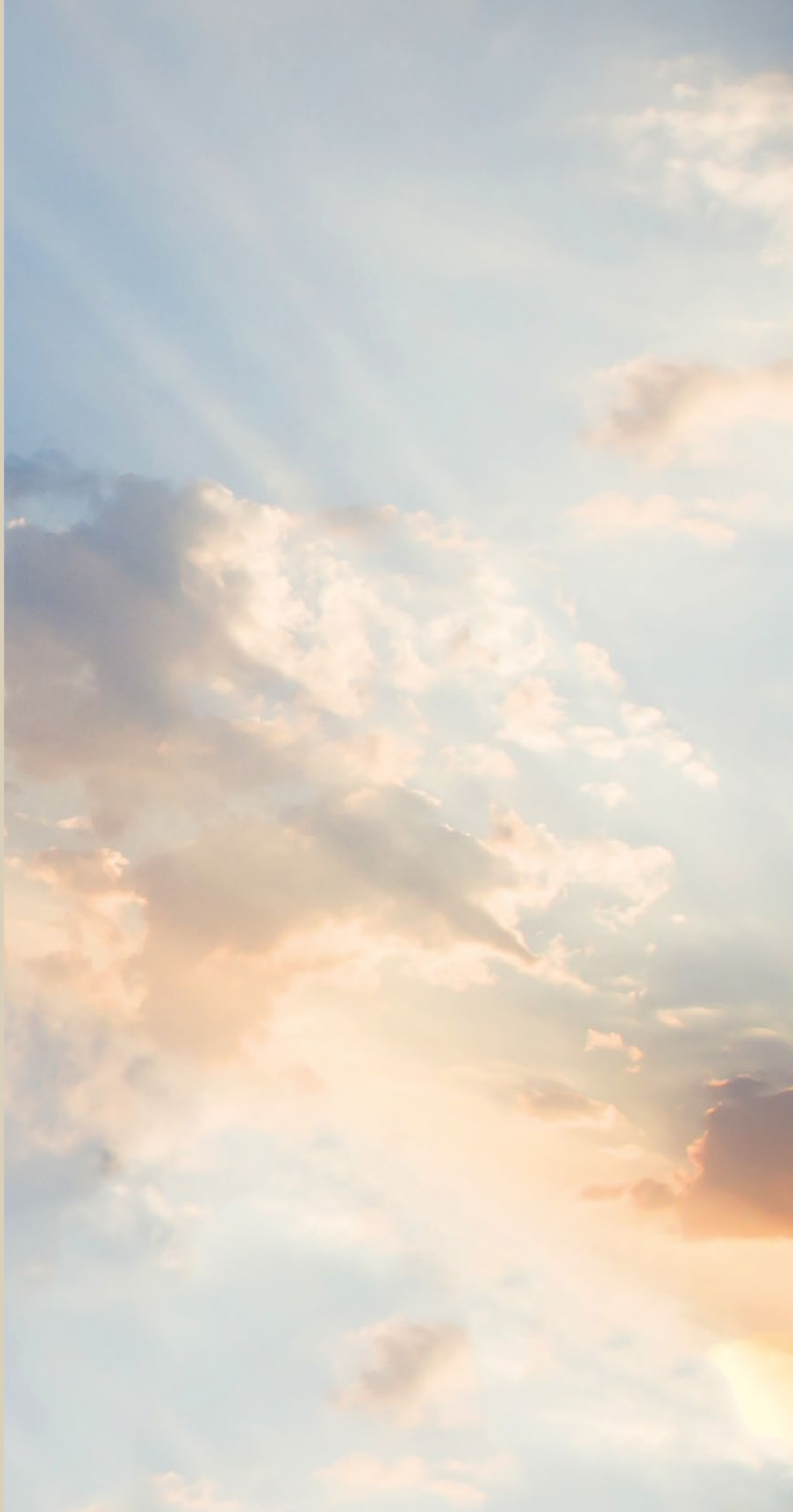

ILLUSTRATION OF AN INSTALLATION WITH GUIDE RAIL KIT



Photovoltaic





ECOSOM



INTRODUCTION

ECOSOM solar stations are easy-to-install pumping units that can be used wherever there is good solar radiation. The solar panels supplied with both ECOSOM “E ” and “I” solar stations recharge the batteries thus to provide energy even when no solar light is available. ECOSOM “L ” solar stations can run exclusively with solar light since they use, directly, the energy coming from the solar panels. ECOSOM solar stations can be combined with electric pumps type SR (for clean water) or SEMISOM (for grey or sewage water), all equipped with 24V DC permanent magnets motors.

APPLICATION

| ECOSOM E - ECOSOM I | | | ECOSOM L | | |
|--|---|---|--|--|---|
| ECOSOM 4/80 | ECOSOM 190 - 320 | ECOSOM 262 - 265 | ECOSOM 4/80 | ECOSOM 190 - 320 | ECOSOM 262 - 265 |
| To pump water from tanks, reservoirs and boreholes | To expel rain water and waste water coming from electric household appliances | To pump water from tanks, reservoirs even in case of solids | To pump water from tanks, reservoirs and boreholes | To pump water from tanks and reservoirs | To pump water from tanks, reservoirs even in case of solids |
| To pressurize civil and industrial plants | To drain tanks, cellars and garages | To expel rain water, waste and sewage water from septic tanks | Irrigation | To transfer water from pools and fountains | To transfer water from pools and fountains |
| Irrigation | To transfer water from pools and fountains | To transfer water from pools and fountains | | Irrigation | Irrigation |
| | Irrigation | Surface irrigation | | | |

APPLICATION RANGE

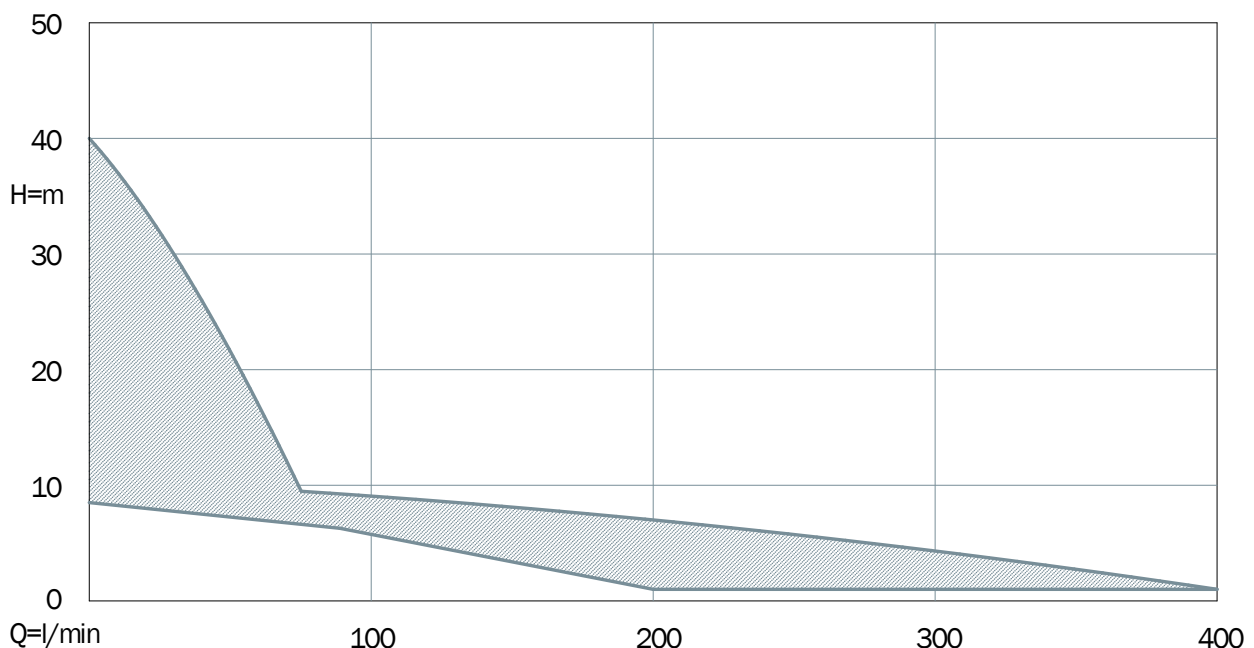

ECOSOM solar pumping stations

PERFORMANCE DATA ECOSOM for clean water

| Type | Code | | | Available electric pumps | | | | | Q | Flow | | | | | | | | | | |
|-------------|-----------|-----------|-----------|--------------------------|------|------|------|-----|-----|-------------------------|-------------------|----|------|-----|-----|-----|-----|----|-----|-----|
| | Version E | Version I | Version L | Type | P2 | | P1 | Max | | Life of the batteries * | m ³ /h | 0 | 0,36 | 0,6 | 1,2 | 1,8 | 2,4 | 3 | 3,6 | 4,2 |
| | | | | | hp | kW | kW | A | min | l/min | 0 | 6 | 10 | 20 | 30 | 40 | 50 | 60 | 70 | 80 |
| ECOSOM 4/80 | DE80/04E | DE80/04I | DE80/04L | SR 4/80 24 V DC | 0,75 | 0,55 | 0,67 | 28 | 120 | H (m) | 40 | 38 | 37 | 34 | 30 | 26 | 21 | 17 | 11 | 7 |

* only for "E" and "I" versions

PERFORMANCE DATA ECOSOM for sewage water

| Type | Code | | | Available electric pumps | | | | | Q | Flow | | | | | | | | | |
|------------|-----------|-----------|-----------|--------------------------|------|------|------|-----|-----|-------------------------|-------------------|-----|-----|-----|-----|-----|-----|-----|-----|
| | Version E | Version I | Version L | Type | P2 | | P1 | Max | | Life of the batteries * | m ³ /h | 0 | 1,8 | 6 | 9 | 12 | 15 | 18 | 21 |
| | | | | | hp | kW | kW | A | min | l/min | 0 | 30 | 100 | 150 | 200 | 250 | 300 | 350 | 400 |
| ECOSOM 190 | DE190E | DE190I | DE190L | SEMISOM 190 24 V DC | 0,5 | 0,37 | 0,58 | 24 | 160 | H (m) | 10,5 | 9,5 | 7 | 4 | 1 | | | | |
| ECOSOM 320 | DE320E | DE320I | DE320L | SEMISOM 320 24 V DC | 0,75 | 0,55 | 0,67 | 28 | 120 | | 11,5 | 11 | 9 | 7,5 | 5,5 | 3 | 0,5 | | |
| ECOSOM 265 | DE265E | DE265I | DE265L | SEMISOM 265 24 V DC | 0,75 | 0,55 | 0,67 | 28 | 120 | | 8,5 | 8 | 6,5 | 5,5 | 4 | 3 | 1 | | |
| ECOSOM 262 | DE262E | DE262I | DE262L | SEMISOM 262 24 V DC | 0,75 | 0,55 | 0,67 | 28 | 120 | | 10,5 | 10 | 9 | 8 | 7 | 6 | 4,5 | 3 | 1 |

* only for "E" and "I" versions

AVAILABLE ELECTRIC PUMPS

| Type | Code | Construction | Application / materials | Characteristics |
|---------------------|-----------|--------------|-------------------------|-----------------|
| SR 24 V DC | RF80/04/1 | see page 11 | see page 12 | see page 16 |
| SEMISOM 190 24 V DC | SF190 | see page 101 | see page 101 | see page 105 |
| SEMISOM 320 24 V DC | SF320 | see page 101 | see page 101 | see page 105 |
| SEMISOM 262 24 V DC | SF262 | see page 109 | see page 109 | see page 115 |
| SEMISOM 265 24 V DC | SF265 | see page 109 | see page 109 | see page 114 |

ECOSOM E with fibreglass cabinet for external installations

CONTROL PANEL

Characteristics

IP rating IP44

Ambient temperature -5/+40 °C

Suitable for external installation

Possibility of installing it to the base of the fixing frame

Easy-to-inspect battery location

Facility to wire float switches for dry running protection

Facility to wire pressure switch, stop and run float switch, etc.

Main components

Fibreglass cabinet

Hand - off - auto selector switch

30 A unipolar thermal protector switch

80 A power relay

Indicator light for: run - pump cut-out - low battery cut-out

20 A automatic charge controller to provide the correct power to the batteries

Fuse holder with fuses on both main and auxiliary circuit

SOLAR MODULES

2 x 180 Wp (+/- 3%) monocrystalline silicon solar cells supplied with fixing bars and frame

ELECTRIC WIRING

The pumping station is supplied with: all cables (pre-wired) for the electric connection of the solar modules, the control panel and the batteries

ACCESSORIES

| Code | Description |
|----------|--|
| 07210005 | FRAME: designed for open-space, land installations with an angle of incidence at 30°. The installation is easy and quick and doesn't require particular tools. All components are in aluminium or stainless steel and their high resistance gives them a long life. |
| 02086005 | BATTERY 12 V 100 Ah: 100 Ah 12 V AGM Long-Life, monobloc, stationary Maintenance-free; 120 minutes life with no light (160 minutes for ECOSOM 190); 8 hours to charge them totally, with pump in stand-by. |

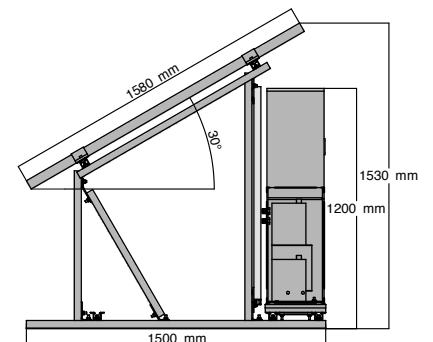
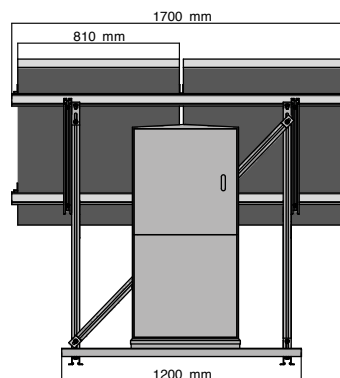

ECOSOM solar pumping stations

ECOSOM I with plastic panel

CONTROL PANEL

Characteristics

IP rating IP55

Ambient temperature -5/+40 °C

Suitable to be installed in sheltered places, away from solar beams

Facility to wire float switches for dry running protection

Facility to wire pressure switch, stop and run float switch, etc.

Main components

Plastic panel: 300 x 400 x 120 mm

Hand - off - auto selector switch

30 A unipolar thermal protector switch

80 A power relay

Indicator light for: run - pump cut-out - low battery cut-out

20 A automatic charge controller to provide the correct power to the batteries

Fuse holder with fuses on both main and auxiliary circuit

SOLAR MODULES

2 x 180 Wp (+/- 3%) monocrystalline silicon solar cells supplied with fixing bars and frame

ELECTRIC WIRING

The pumping station is supplied with: all cables (pre-wired) for the electric connection of the solar modules, the control panel and the batteries

ACCESSORIES

| Code | Description |
|----------|---|
| 07210005 | <p>FRAME: designed for open-space, land installations with an angle of incidence at 30°. The installation is easy and quick and doesn't require particular tools. All components are in aluminium or stainless steel and their high resistance gives them a long life.</p> |
| 02086005 | <p>BATTERY 12 V 100 Ah: 100 Ah 12 V AGM Long-Life, monobloc, stationary Maintenance-free; 120 minutes life with no light (160 minutes for ECOSOM 190); 8 hours to charge them totally, with pump in stand-by.</p> |

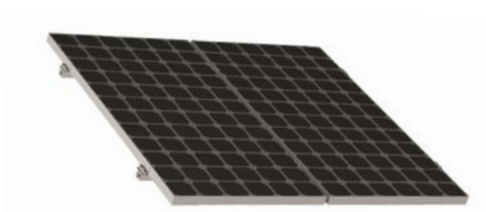

ECOSOM L with plastic panel and without batteries

CONTROL PANEL

Characteristics

IP rating IP65

Ambient temperature -5/+40 °C

Suitable to be installed in sheltered places, away from solar beams

Facility for automatic device (ex: level control)

Main components

Plastic panel: 220 x 300 x 120 mm

Hand - off - auto selector switch

Unipolar thermal protector switch to protect the electric pump from overload

Indicator light for pump running

SUGGESTED SOLAR MODULES (NOT included)

Open circuit voltage (Voc) < 40 V

Maximum power voltage (Vmp) > 29 V

Required power to run the station:
P1 of the electric pump + 30% (Max. 1000 Wp)



IDROSOLAR



INTRODUCTION

The solar stations IDROSOLAR allow pumping water from a well with complete autonomy and can be easily installed anywhere there is a good solar radiation. Using the sunlight, they can produce the energy required to run the electric pump. The number of revolutions of the pump is continuously adapted to available radiation, thus maximizing the flow of the water pumped. (MPPT function: Maximum Power Point Tracking).
When radiation levels increase so do the revolutions of the pump and, consequently, the flow rises.
When the radiation decreases, (clouds passing by or different times of the day) the revolutions of the pump get lower and thus its flow. However, the system continues to supply water until the radiation falls below the minimum necessary operation point. In addition, the system is completely protected against overvoltage, over current and lack of water.

APPLICATION

To pump water from boreholes

Irrigation

APPLICATION RANGE

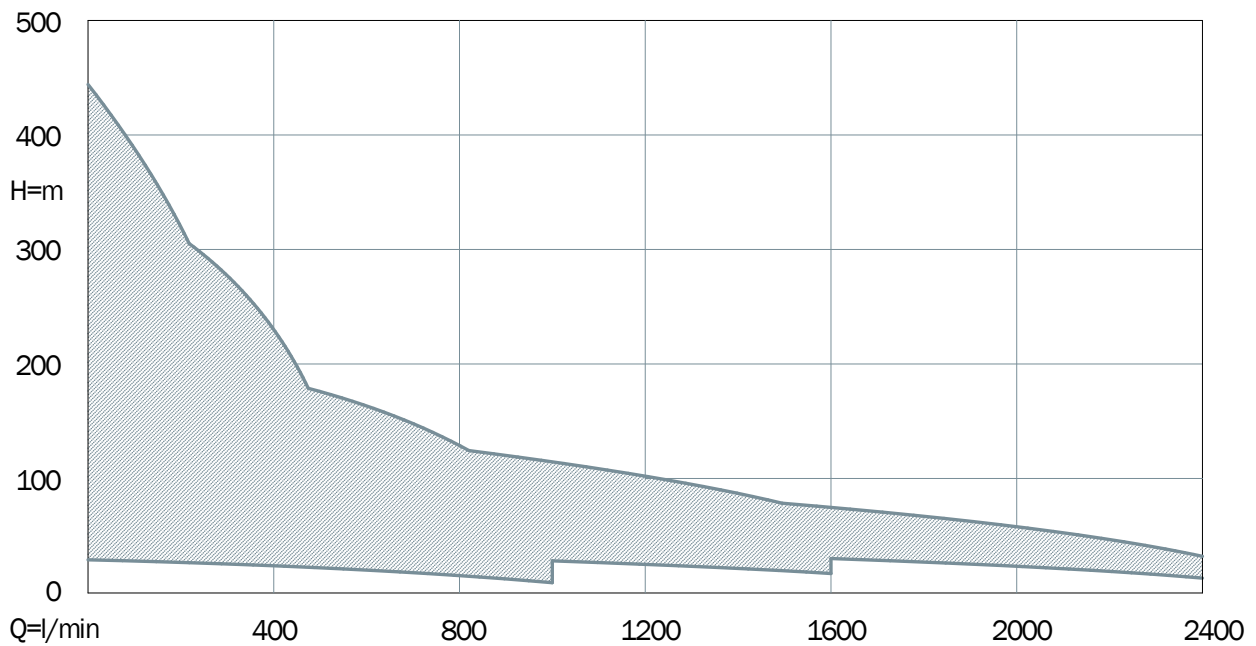

Photovoltaic pumping stations IDROSOLAR

PERFORMANCE CHARACTERISTICS

| Type | MOTOR | | PUMP END | | | | SUGGESTED SOLAR MODULES* | | |
|-----------------|-------|------|----------|-------|------|------|--------------------------|---------------------|-------------------------|
| | P2 | | H | | Q | | Number of strings | Modules each string | Total number of modules |
| | hp | kW | from | to | from | to | | | |
| | | m | | l/min | | | | | |
| IDROSOLAR 1200 | 1 | 0,75 | 13 | 90 | 10 | 175 | 1 | 5 | 5 |
| IDROSOLAR 1800 | 1,8 | 1,35 | 13 | 122 | 10 | 225 | 1 | 7 | 7 |
| IDROSOLAR 2800 | 2,8 | 2 | 11 | 188 | 10 | 300 | 1 | 11 | 11 |
| IDROSOLAR 3600 | 3,6 | 2,7 | 12 | 245 | 10 | 350 | 1 | 14 | 14 |
| IDROSOLAR 5500 | 5,5 | 4 | 9 | 295 | 20 | 1000 | 1 | 20 | 20 |
| IDROSOLAR 7500 | 7,5 | 5,5 | 13 | 223 | 75 | 1000 | 2 | 13 | 26 |
| IDROSOLAR 10000 | 10 | 7,5 | 17 | 250 | 75 | 1600 | 2 | 19 | 38 |
| IDROSOLAR 12500 | 12,5 | 9,2 | 23 | 307 | 90 | 1000 | 3 | 18 | 54 |
| IDROSOLAR 15000 | 15 | 11 | 13 | 361 | 90 | 2400 | 3 | 19 | 57 |
| IDROSOLAR 20000 | 20 | 15 | 34 | 323 | 150 | 1600 | 4 | 18 | 72 |
| IDROSOLAR 25000 | 25 | 18,5 | 19 | 383 | 150 | 2400 | 4 | 21 | 84 |
| IDROSOLAR 30000 | 30 | 22 | 26 | 290 | 200 | 2400 | 5 | 20 | 100 |
| IDROSOLAR 40000 | 40 | 30 | 32 | 190 | 400 | 2400 | 6 | 21 | 126 |

* The above calculations have been made considering solar panels with the following specifications

- Open circuit voltage (Voc) < 40,5 V
- Maximum power voltage (Vmp) > 30,8 V
- Maximum power current (Imp) < 10 A
- Maximum power rating (Pmax) ≥ 280 Wp

PUMP TYPE COMBINATIONS

| Type | Construction | Application/materials |
|--|--------------|-----------------------|
| Electric submersible pumps IDROSOM for 4" boreholes | see page 35 | see page 36 - 37 |
| Electric submersible pumps IDROSAND for 6" boreholes | see page 49 | see page 50 - 51 |
| Electric submersible pumps for 8" boreholes | see page 67 | see page 68 - 69 |

IDROSOLAR

Characteristics

IP rating IP54

Ambient temperature -5/+40 °C

Suitable for external applications

Solar Inverter with MPPT and protection against overvoltage, over current and lack of water

Facility for remote control to run and stop the pump

Dimensions: 434 x 504 x 210 mm

Main components

Fibreglass cabinet

Opening interlocked

Display to set and check the electric pump

Surge protector for photovoltaic systems

Protective fuses

Hand - off - auto selector switch

Led indicator lamps for run and alarm



IDROSOLAR L

Characteristics

IP rating IP65

Ambient temperature -5/+40 °C

Suitable to be installed in sheltered places, away from solar beams

Solar Inverter with MPPT and protection against overvoltage, over current and lack of water

Facility for remote control to run and stop the pump

Dimensions: 300 x 400 x 190 mm

Main components

Inverter case in powder coated, die-cast aluminium

Connection box in plastic

Steel-sheet fixing plate

Display to set and check the electric pump

Button to start and stop the electric pump

Terminal board for wiring the solar panels

Fuses to protect the inverter



Panels and Accessories

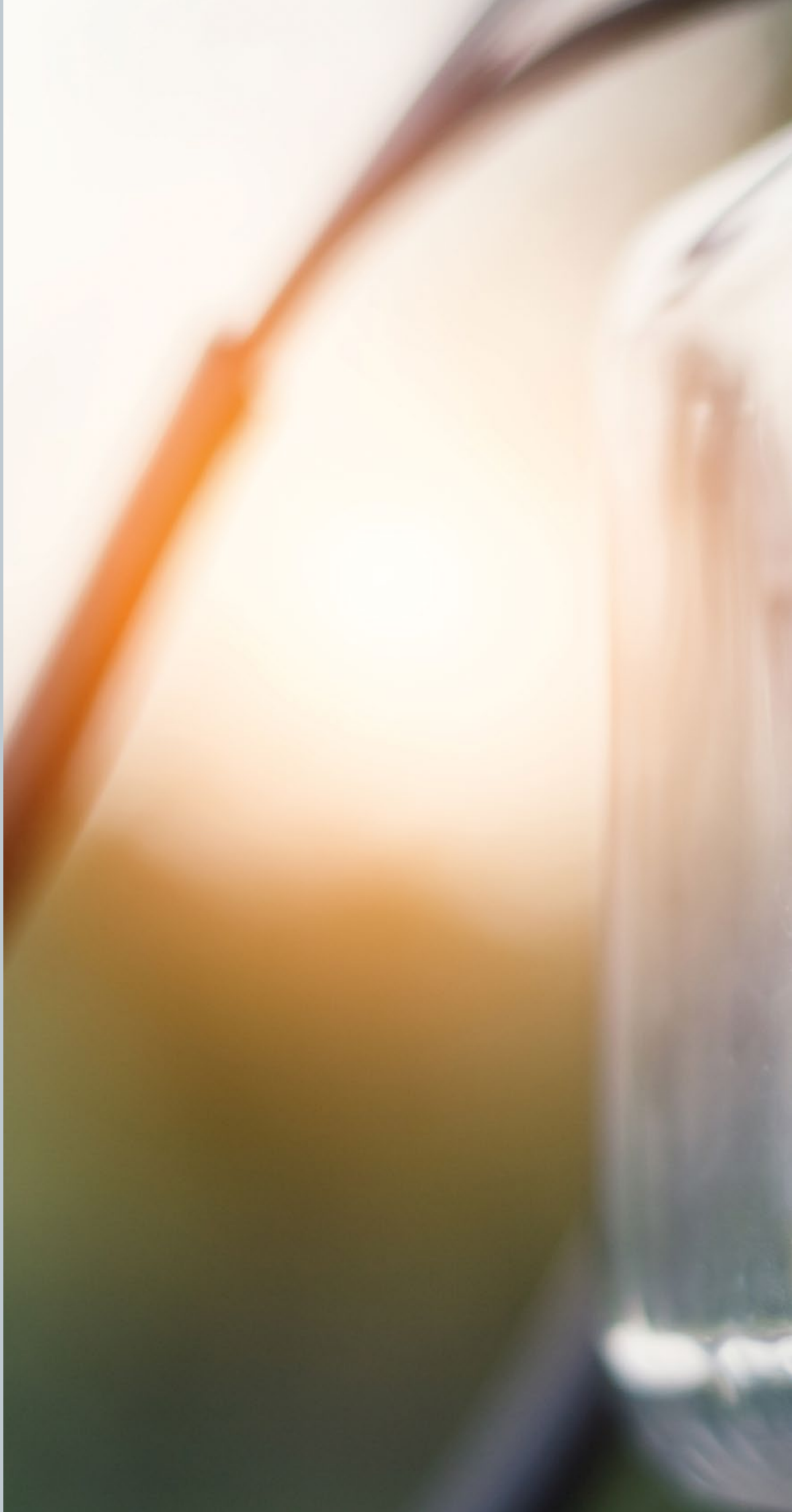



Control and protection panels

QM IT -Single-Phase direct starters

CHARACTERISTICS

IP rating IP40

Ambient Temperature -5/+40 °C

N° 1 facility for wiring a pump controller (float switch, pressure switch, etc.), 1~230V

MAIN COMPONENTS

Plastic panel

Bipolar, illuminated thermal protector switch

OPTIONS

Also available in IP55 rating



| Type | Code | Approx. Power | | A max | Dimensions mm |
|---------------------------------|----------|---------------|-------------|-------|------------------|
| | | hp | kW | | |
| Single-phase 230 V 50 Hz | | | | | |
| QM IT 3 | 02070005 | 0,35 - 0,5 | 0,26 - 0,37 | 3 | 150 x 110 x 70 |
| QM IT 5 | 02070010 | 0,5 - 0,75 | 0,37 - 0,55 | 5 | |
| QM IT 7 | 02070015 | 0,9 - 1,1 | 0,65 - 0,8 | 7 | |
| QM IT 10 | 02070025 | 1,3 - 1,6 | 0,95 - 1,2 | 10 | |
| QM IT 12 | 02070030 | 2 | 1,5 | 12 | |
| QM IT 18 | 02070035 | 3 | 2,2 | 18 | |

QT MT - Three-phase Electromechanical direct starters

CHARACTERISTICS

IP rating IP65

Ambient Temperature -5/+40 °C

N° 1 facility for wiring a pump controller (float switch, pressure switch, temperature sensor etc.)

N° 2 facilities for wiring stand and stop float switches

MAIN COMPONENTS

Plastic panel

Bipolar, illuminated thermal protector switch

Run contactor

Low-voltage auxiliary circuits (24 V) with fuses

Lamp for pump running



| Type | Code | Approx. Power | | A min | A max | Dimensions mm |
|--------------------------------|----------|---------------|-------------|-------|-------|------------------|
| | | hp | kW | | | |
| Three-phase 400 V 50 Hz | | | | | | |
| QT MT 2,5 | 02081110 | 0,5 - 0,9 | 0,37 - 0,65 | 1,6 | 2,5 | 250 x 200 x 110 |
| QT MT 4 | 02081120 | 1 - 1,6 | 0,75 - 1,2 | 2,5 | 4 | |
| QT MT 6 | 02081130 | 2 - 3 | 1,5 - 2,2 | 4 | 6,3 | |
| QT MT 10 | 02081140 | 4 | 3 | 6,3 | 10 | |

QDC - DC Electromechanical direct starter

CHARACTERISTICS

IP rating IP40

Ambient Temperature -5/+40 °C

N° 1 facility for wiring a pump controller (float switch, pressure switch, temperature sensor etc.)

MAIN COMPONENTS

Plastic panel

Unipolar thermal protector switch

Power relay

Hand - off - auto selector switch

Lamp for pump running



| Type | Code | Approx. Power | | A max | Dimensions mm |
|----------------|----------|---------------|-------------|-------|------------------|
| | | hp | kW | | |
| 24 V DC | | | | | |
| QDC | 02076100 | 0,5 - 0,75 | 0,37 - 0,55 | 30 | 190 x 140 x 70 |

QM BT - Single-phase electronic starter with level control

CHARACTERISTICS

IP rating IP40

Ambient Temperature -5/+40 °C

N° 1 facility for wiring a pump controller (float switch, pressure switch, temperature sensor etc.)

N° 3 facilities for wiring level probes (2 with switched timer) that can also be used with one or two float switches

MAIN COMPONENTS

Plastic panel

Bipolar, illuminated thermal protector switch

Electronic level control

Led lights for: run - minimum level - cut-out

Low-voltage auxiliary circuits

OPTIONS

Also available in IP55 rating



| Type | Code | Approx. Power | | A max | Dimensions mm |
|---------------------------------|----------|---------------|-------------|-------|------------------|
| | | hp | kW | | |
| Single-phase 230 V 50 Hz | | | | | |
| QM BT 3 | 02075003 | 0,35 - 0,5 | 0,26 - 0,37 | 3 | 190 x 140 x 70 |
| QM BT 5 | 02075010 | 0,5 - 0,75 | 0,37 - 0,55 | 5 | |
| QM BT 7 | 02075015 | 0,9 - 1,1 | 0,65 - 0,8 | 7 | |
| QM BT 10 | 02075020 | 1,3 - 1,6 | 0,95 - 1,2 | 10 | |
| QM BT 12 | 02075025 | 2 | 1,5 | 12 | |

QT CL - Three-phase electromechanical direct starters with level control

CHARACTERISTICS

IP rating IP65

Ambient Temperature -5/+40 °C

N° 1 facility for wiring a pump controller (float switch, pressure switch, temperature sensor etc.)

N° 3 facilities for wiring level probes that can also be used with one or two float switches

MAIN COMPONENTS

Plastic panel

Circuit breaker

Run contactor

Low-voltage auxiliary circuit (24 V) with fuses

Electronic level control

Led lights for power and run



| Type | Code | Approx. Power | | A min | A max | Dimensions mm |
|--------------------------------|----------|---------------|-------------|-------|-------|------------------|
| | | hp | kW | | | |
| Three-phase 400 V 50 Hz | | | | | | |
| QT 2,5 CL | 02081111 | 0,5 - 0,9 | 0,37 - 0,65 | 1,6 | 2,5 | 250 x 200 x 110 |
| QT 4 CL | 02081121 | 1 - 1,6 | 0,75 - 1,2 | 2,5 | 4 | |
| QT 6 CL | 02081131 | 2 - 3 | 1,5 - 2,2 | 4 | 6,3 | |
| QT 10 CL | 02081141 | 4 | 3 | 6,3 | 10 | |

Control and protection panels

AM - AT - Direct-on line starters for single and three-phase pumps with level control

CHARACTERISTICS

IP rating IP55

Ambient Temperature -5/+40 °C

N° 1 facility for wiring a pump controller (float switch, pressure switch, temperature sensor etc.)

N° 3 facilities for wiring level probes that can also be used with one or two float switches

MAIN COMPONENTS

Plastic panel

Opening interlocked

Run contactor

Low-voltage auxiliary circuit (24 V) with fuses

Thermal relay for motor protection

Set of fuses for motor protection

Electronic level control by means of a microprocessor

Hand - off - auto selector switch

Led lights for power and motor running, thermal cut-out and level cut-out



| Type | Code | Approx. Power | | A min | A max | Dimensions mm |
|---------------------------------|----------|---------------|-----------|-------|-------|------------------|
| | | hp | kW | | | |
| Single-phase 230 V 50 Hz | | | | | | |
| AM 20 CL | 02080025 | 2 | 1,5 | 9 | 13 | 220 x 300 x 120 |
| AM 30 CL | 02080030 | 3 | 2,2 | 12 | 18 | |
| Three-phase 400 V 50 Hz | | | | | | |
| AT 55 CL | 02081030 | 5,5 | 4 | 9 | 13 | 220 x 300 x 120 |
| AT 75 CL | 02081035 | 7,5 | 5,5 | 12 | 18 | |
| AT 125 CL | 02081040 | 10 - 12,5 | 7,5 - 9,2 | 17 | 25 | |
| AT 150 CL | 02081045 | 15 | 11 | 22 | 32 | |

P2 BPA2 - P2 BPTA2 - Direct on line electromechanical single/three-phase starters for 2 electric pumps

CHARACTERISTICS

IP rating IP55

Ambient Temperature -5/+40 °C

N° 3 facilities for wiring a start - stop alternate-duty-assist device (float switch, pressure switch, etc.)

N° 1 facility for maximum level alarm device

N° 1 Volt-free facility for alarm device

MAIN COMPONENTS

Plastic panel

Opening interlocked

Low-voltage auxiliary circuit (24 V) with fuses

Run contactors

Thermal relays to protect the motors (in case of intervention, the stand-by pump is immediately turned ON)

Set of fuses for motor

Electronic circuit with microprocessor to control the alternate or simultaneous run of the electric pumps

Hand - off - auto selector switch

Led lights for: run P1 and P2 - thermal cut-out P1 and P2

ACCESSORIES

Power failure alarm



| Type | Code | Approx. Power | | A min | A max | Dimensions mm |
|---------------------------------|------------|---------------|-------------|-------|-------|--------------------|
| | | hp | kW | | | |
| Single-phase 230 V 50 Hz | | | | | | |
| P2 BPA2 4 | ZP2BPA2/1 | 0,5 | 0,37 | 2,5 | 4 | 300 x 380 x 120 |
| P2 BPA2 6 | | 0,75 - 1 | 0,55 - 0,75 | 4 | 6,3 | |
| P2 BPA2 10 | | 1,5 | 1,1 | 7 | 10 | |
| P2 BPA2 13 | | 2 | 1,5 | 9 | 13 | |
| Three-phase 400 V 50 Hz | | | | | | |
| P2 BPTA2 2 | ZP2BPTA2/1 | 0,5 | 0,37 | 1,2 | 1,9 | 300 X 380 X 120 |
| P2 BPTA2 2,5 | | 0,75 | 0,55 | 1,6 | 2,5 | |
| P2 BPTA2 4 | | 1 - 1,5 | 0,75 - 1,1 | 2,5 | 4 | |
| P2 BPTA2 6 | | 2 - 3 | 1,5 - 2,2 | 4 | 6,3 | |
| P2 BPTA2 10 | | 4,5 | 3,4 | 7 | 10 | |

ATI - Three-phase Inverter starters

CHARACTERISTICS

| |
|---|
| IP rating IP40 |
| Ambient Temperature -5/+40 °C |
| N° 2 facilities for wiring a pump controller (float switch, pressure switch, temperature sensor etc.) |
| N° 2 facilities for wiring start - stop float switches |
| N° 1 facility for wiring a pressure transducer 4÷20 mA 0÷10 bar |

MAIN COMPONENTS

| |
|--|
| Steel-sheet control panel |
| Opening interlocked |
| Low-voltage auxiliary circuits (24V) with fuses |
| Inverter with display, setting keyboard and internal fan |
| Set of fuses to protect the inverter |
| Hand - off - auto selector switches. In Hand: using constant frequency (50 Hz) via pressure switch, float switch, etc. In Auto: using variable frequency (30÷50 Hz) via pressure transducer 4÷20 mA 0÷10 bar |
| Lamps for: power - run - alarm - level cut-out |

ACCESSORIES

| |
|--------------------|
| Pressure trasducer |
|--------------------|



| Type | Code | Approx. Power | | A max | Dimensions mm |
|--|----------|---------------|------------|-------|------------------|
| | | hp | kW | | |
| Single-Phase line 230 V 50 Hz - Three-phase motor 230 V 50 Hz | | | | | |
| ATI 230 10 | 02077010 | 1 | 0,75 | 4,2 | 300 x 400 x 200 |
| ATI 230 20 | 02077020 | 1 - 2 | 0,75 - 1,5 | 6,8 | |
| ATI 230 30 | 02077030 | 2 - 3 | 1,5 - 2,2 | 9,6 | 400 x 600 x 250 |
| Three-phase line 400 V 50 Hz - Three-phase motor 400 V 50 Hz | | | | | |
| ATI 400 10 | 02078010 | 1 | 0,75 | 2,2 | 300 x 400 x 200 |
| ATI 400 20 | 02078020 | 1 - 2 | 0,75 - 1,5 | 3,7 | |
| ATI 400 30 | 02078030 | 2 - 3 | 1,5 - 2,2 | 5,3 | 400 x 600 x 250 |
| ATI 400 40 | 02078040 | 3 - 4 | 2,2 | 7,2 | |
| ATI 400 55 | 02078050 | 4 - 5,5 | 3 - 4 | 9 | |
| ATI 400 75 | 02078060 | 5,5 - 7,5 | 4 - 5,5 | 12 | |
| ATI 400 100 | 02078070 | 7,5 - 10 | 5,5 - 7,5 | 15,5 | |

ATRS - Three-phase soft starters

CHARACTERISTICS

| |
|---|
| IP rating IP55 |
| Ambient Temperature -5/+40 °C |
| N° 1 facility for wiring a pump controller (float switch, pressure switch, temperature sensor etc.) |
| N° 2 facilities for wiring start – stop float switches |
| N° 3 facilities for wiring level probes |

MAIN COMPONENTS

| |
|--|
| Steel-sheet control panel |
| Opening interlocked |
| Low-voltage auxiliary circuits (24V) with fuses |
| Set of fuses to protect the motor |
| Hand - off - auto selector switch |
| Lamps for: power - run - thermal cut-out – level cut-out |



| Type | Code | Approx. Power | | A min | A max | Dimensions mm |
|--------------------------------|----------|---------------|-----------|-------|-------|------------------|
| | | hp | kW | | | |
| Three-phase 400 V 50 Hz | | | | | | |
| ATRS 10 | 02079010 | 7,5 - 12,5 | 5,5 - 9,2 | 12 | 25 | 300 x 400 x 200 |
| ATRS 20 | 02079020 | 15 - 20 | 11 - 15 | 14 | 32 | |
| ATRS 25 | 02079030 | 25 | 18,5 | 23 | 45 | 400 x 600 x 250 |
| ATRS 35 | 02079050 | 30 - 35 | 22 - 26 | 30 | 60 | |
| ATRS 40 | 02079060 | 40 | 30 | 37,5 | 75 | 500 x 700 x 250 |
| ATRS 50 | 02079070 | 50 | 37 | 42,5 | 85 | |
| ATRS 60 | 02079080 | 60 | 45 | 60 | 115 | |
| ATRS 75 | 02079090 | 75 | 55 | 70 | 142 | 600 x 800 x 300 |

Control and protection panels

ATS - Direct-on-line electromechanical three-phase starters for electric pumps Semisom/80

CHARACTERISTICS

| |
|---|
| IP rating IP55 |
| Ambient Temperature -5/+40 °C |
| N° 1 facility for wiring the humidity probe of the first chamber |
| N° 1 facility for wiring the temperature sensor |
| N° 1 facility for wiring a pump controller (float switch, pressure switch, temperature sensor etc.) |
| N° 2 facilities for wiring start – stop float switches |
| N° 1 facility for maximum level float switch |
| N° 1 facility for 24 V AC alarm device |

MAIN COMPONENTS

| |
|--|
| Steel-sheet control panel |
| Opening interlocked |
| Low-voltage (24 V) auxiliary circuits with fuses |
| Run contactor |
| Thermal relay for motor protection |
| Relay to control motor overheating |
| Set of fuses to protect the motor |
| Electronic control in case of humidity in the first chamber |
| Hand - off - auto selector switch |
| Lamps for: power - run - thermal cut-out - cut-out for motor overheating - cut-out for humidity in the first chamber - maximum level cut-out |



| Type | Code | Approx. Power | | A min | A max | Dimensions mm |
|--------------------------------|----------|---------------|-----------|-------|-------|------------------|
| | | hp | kW | | | |
| Three-phase 400 V 50 Hz | | | | | | |
| ATS 55 | 02082010 | 3,5 - 5,5 | 2,6 - 4 | 7 | 10 | 300 x 400 x 150 |
| ATS 100 | 02082020 | 7,5 - 10 | 5,5 - 7,5 | 12 | 18 | |
| ATS 110 | 02082030 | 11 | 8 | 17 | 25 | |

AT2S - Direct-on-line electromechanical three-phase starters for 2 electric pumps Semisom/80

CHARACTERISTICS

| |
|--|
| IP rating IP55 |
| Ambient Temperature -5/+40 °C |
| N° 2 facilities to wire the humidity probes of the first chamber |
| N° 2 facilities for wiring the temperature sensors |
| N° 3 facilities for wiring a start - stop alternate-duty-assist device (float switch, pressure switch, etc.) |
| N° 1 facility for maximum level alarm device |
| N° 1 Volt-free facility for alarm device |

MAIN COMPONENTS

| |
|--|
| Steel-sheet control panel |
| Opening interlocked |
| Low-voltage (24 V) auxiliary circuits with fuses |
| Run contactors |
| Thermal relays for motor protection |
| Relays to control motor overheating |
| Set of fuses to protect the motor |
| Electronic control in case of humidity in the first chambers |
| Hand - off - auto selector switches |
| Electronic circuit with microprocessor to control the alternate or simultaneous run of the electric pumps |
| Lamps for: power - pump 1 - pump 2 - thermal cut-out - cut-out for motor overheating - cut our for humidity in the first chamber |



ACCESSORIES

Power failure alarm

| Type | Code | Approx. Power | | A min | A max | Dimensions mm |
|--------------------------------|----------|---------------|-----------|-------|-------|------------------|
| | | hp | kW | | | |
| Three-phase 400 V 50 Hz | | | | | | |
| AT2S 55 | 02082110 | 3,5 - 5,5 | 2,6 - 4 | 7 | 10 | 400 x 600 x 200 |
| AT2S 100 | 02082120 | 7,5 - 10 | 5,5 - 7,5 | 12 | 18 | |
| AT2S 110 | 02082130 | 11 | 8 | 17 | 25 | |

QA 12 - Power failure alarm

CHARACTERISTICS

IP rating IP40

Ambient Temperature -5/+40 °C

N° 1 facility for Volt-free alarm device

12 hour-life battery

MAIN COMPONENTS

Plastic panel

On - off - test selector switch

102 db/1m acoustic alarm

Led visual alarm

230 V battery charger supplied with 6 V nickel cadmium battery



| Type | Code | Dimensions |
|-------|----------|----------------|
| | | mm |
| QA 12 | 02064030 | 190 x 140 x 70 |

Accessories

Electrodes



CHARACTERISTICS

Plastic material

Conductance probe in stainless steel AISI304

Suitable for cables up to 2,5 mm²

| Code | Description |
|----------|--|
| 03605011 | Electric probe ESU E |
| 01901016 | Cable for probes 1 x 1,5 mm ² |

Float switches



CHARACTERISTICS

Cable size 3 x 1 mm²

IP rating IP68

Dual function (emptying and filling)

10 (4) A switch

| Code | Description |
|----------|-----------------------|
| 02034045 | Float switch 2 m PVC |
| 02034060 | Float switch 5 m PVC |
| 02034040 | Float switch 10 m PVC |
| 02034042 | Float switch 15 m PVC |
| 02034050 | Float switch 20 m PVC |

| Code | Description |
|----------|--|
| 02034015 | Float switch for sewage water 5 m PVC |
| 02034005 | Float switch for sewage water 10 m PVC |

| Code | Description |
|----------|--------------------------------|
| 03105005 | Counterweight for float switch |

Start and control devices



CHARACTERISTICS

Built-in pressure gauge

Adjustable pressure

Dry running protection

Power up to 1,5 kW

| Code | Description |
|----------|-------------------------|
| 06605040 | Pressure flow regulator |

Capacitors



CHARACTERISTICS

450 V 3000 h continuous duty

| Code | Description |
|----------|------------------------|
| 02008005 | Capacitor 10 μ F |
| 02008015 | Capacitor 12,5 μ F |
| 02008025 | Capacitor 16 μ F |
| 02008030 | Capacitor 20 μ F |
| 02008040 | Capacitor 25 μ F |
| 02008045 | Capacitor 31,5 μ F |
| 02008050 | Capacitor 35 μ F |
| 02008055 | Capacitor 40 μ F |
| 02008060 | Capacitor 45 μ F |
| 02008065 | Capacitor 50 μ F |
| 02008070 | Capacitor 60 μ F |

Electric cables

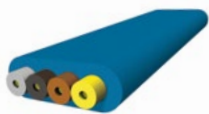
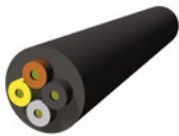

| Code | Description |
|---|--|
| Cables for permanent immersion | |
| 01902016 | H07 RN8-F round cable 3 x 1 mm ² |
| 01902051 | H07 RN8-F round cable 4 x 1 mm ² |
| 01902056 | H07 RN8-F round cable 4 x 1,5 mm ² |
| 01906070 | AD8 round cable 4 x 1,5 mm ² + 2 x 0,75 mm ² |
| 01906090 | AD8 round cable 4 x 2,5 mm ² + 3 x 0,75 mm ² |
| Cables for permanent immersion in drinking water | |
| 01906050 | ACS AD8 round cable 4 x 1 mm ² |
| 01906060 | ACS AD8 round cable 4 x 1,5 mm ² |
| Cables for permanent immersion in drinking water | |
| 01922050 | ACS AD8 flat cable 4 x 4 mm ² |
| 01922055 | ACS AD8 flat cable 4 x 6 mm ² |

Non-return valves



| Code | Description |
|--------------------|--|
| 05405031 | Non-return valve 1"½ GAS threaded |
| 05405035 | Non-return valve 2" GAS threaded |
| Code | |
| Description | |
| 05430010 | Non-return ball valve 1"½ GAS |
| 05430015 | Non-return ball valve 2" GAS |
| 05430020 | Non-return ball valve 2"½ GAS threaded |
| 05430110 | Non-return ball valve DN80 PN16 threaded |

Pressure lost chart

Pressure loss in pipes for 100m run

| Flow | | | Internal diameter of the pipe | | | | | | | | | | | | | | | |
|--|-------|------|-------------------------------|------|------|--------|--------|------|--------|--------|------|------|------|------|------|------|------|------|
| | | | gas | 3/4" | 1" | 1" 1/4 | 1" 5/8 | 2" | 2" 1/2 | 3" 1/8 | 4" | 5" | 6" | 7" | 8" | 10" | 12" | 16" |
| l/sec | l/min | m³/h | mm | 20 | 25 | 32 | 40 | 50 | 65 | 80 | 100 | 125 | 150 | 175 | 200 | 250 | 300 | 400 |
| Pressure loss in meters of column of water | | | | | | | | | | | | | | | | | | |
| 0,16 | 10 | 0,6 | | 2,6 | 1 | 0,28 | 0,09 | | | | | | | | | | | |
| 0,25 | 15 | 0,9 | | 6,5 | 2,15 | 0,6 | 0,18 | | | | | | | | | | | |
| 0,33 | 20 | 1,2 | | 10 | 3,5 | 1 | 0,3 | 0,11 | | | | | | | | | | |
| 0,41 | 25 | 1,5 | | 15 | 5,5 | 1,6 | 0,5 | 0,16 | | | | | | | | | | |
| 0,5 | 30 | 1,8 | | 22 | 8 | 2,2 | 0,65 | 0,23 | | | | | | | | | | |
| 0,66 | 40 | 2,4 | | 40 | 13 | 4 | 1,2 | 0,4 | 0,1 | | | | | | | | | |
| 0,83 | 50 | 3 | | 60 | 21 | 6 | 1,8 | 0,6 | 0,16 | | | | | | | | | |
| 1 | 60 | 3,6 | | 75 | 28 | 8 | 2,4 | 0,85 | 0,22 | | | | | | | | | |
| 1,16 | 70 | 4,2 | | | 40 | 11,5 | 3,2 | 1,15 | 0,3 | 0,11 | | | | | | | | |
| 1,33 | 80 | 4,8 | | | 54 | 14,5 | 4,5 | 1,5 | 0,4 | 0,14 | | | | | | | | |
| 1,5 | 90 | 5,4 | | | 65 | 18 | 5,3 | 1,8 | 0,48 | 0,16 | | | | | | | | |
| 1,66 | 100 | 6 | | | 77 | 22 | 6,5 | 2,2 | 0,52 | 0,2 | | | | | | | | |
| 2 | 120 | 7,2 | | | | 30 | 9 | 3 | 0,8 | 0,3 | | | | | | | | |
| 2,33 | 140 | 8,4 | | | | 42 | 12 | 4,2 | 1,1 | 0,38 | 0,13 | | | | | | | |
| 2,66 | 160 | 9,6 | | | | 53 | 16 | 5,3 | 1,4 | 0,5 | 0,17 | | | | | | | |
| 3 | 180 | 10,8 | | | | 65 | 20 | 6,5 | 1,7 | 0,6 | 0,21 | | | | | | | |
| 3,33 | 200 | 12 | | | | 78 | 24 | 8 | 2,1 | 0,72 | 0,26 | | | | | | | |
| 3,66 | 220 | 13,2 | | | | 90 | 26,5 | 9 | 2,4 | 0,84 | 0,3 | 0,1 | | | | | | |
| 4 | 240 | 14,4 | | | | | 33 | 11,3 | 3 | 1,1 | 0,37 | 0,12 | | | | | | |
| 4,33 | 260 | 15,6 | | | | | 40 | 13,5 | 3,5 | 1,22 | 0,43 | 0,14 | | | | | | |
| 4,66 | 280 | 16,8 | | | | | 45 | 15 | 4 | 1,4 | 0,48 | 0,16 | | | | | | |
| 5 | 300 | 18 | | | | | 51 | 17 | 4,5 | 1,6 | 0,51 | 0,18 | | | | | | |
| 5,83 | 350 | 21 | | | | | 68 | 24 | 6 | 2,1 | 0,75 | 0,24 | | | | | | |
| 6,66 | 400 | 24 | | | | | 87 | 29 | 7,8 | 2,65 | 0,95 | 0,31 | 0,12 | | | | | |
| 7,5 | 450 | 27 | | | | | | 38 | 9,6 | 3,3 | 1,18 | 0,38 | 0,15 | | | | | |
| 8,33 | 500 | 30 | | | | | | 45 | 11,8 | 4,2 | 1,4 | 0,47 | 0,18 | | | | | |
| 9,16 | 550 | 33 | | | | | | 55 | 14 | 5 | 1,7 | 0,51 | 0,21 | 0,1 | | | | |
| 10 | 600 | 36 | | | | | | 64 | 16,5 | 5,5 | 2 | 0,65 | 0,25 | 0,12 | | | | |
| 11,6 | 700 | 42 | | | | | | 87 | 23 | 8 | 2,8 | 0,9 | 0,32 | 0,16 | | | | |
| 13,3 | 800 | 48 | | | | | | | 30 | 10,5 | 3,5 | 1,18 | 0,44 | 0,21 | 0,11 | | | |
| 16,6 | 1000 | 60 | | | | | | | 44 | 15 | 5,3 | 1,8 | 0,65 | 0,31 | 0,16 | | | |
| 20 | 1200 | 72 | | | | | | | 62 | 22 | 7,5 | 2,5 | 0,95 | 0,45 | 0,22 | | | |
| 23,3 | 1400 | 84 | | | | | | | 81 | 28,5 | 10 | 3,25 | 1,25 | 0,6 | 0,3 | 0,1 | | |
| 26,6 | 1600 | 96 | | | | | | | | 37,5 | 13 | 4,3 | 1,6 | 0,78 | 0,38 | 0,13 | | |
| 30 | 1800 | 108 | | | | | | | | 46 | 16 | 5,3 | 2 | 0,95 | 0,47 | 0,16 | | |
| 33,3 | 2000 | 120 | | | | | | | | 56,5 | 19,5 | 6,5 | 2,4 | 1,15 | 0,58 | 0,19 | | |
| 36,6 | 2200 | 132 | | | | | | | | 65 | 23 | 7,7 | 2,9 | 1,38 | 0,7 | 0,23 | | |
| 40 | 2400 | 144 | | | | | | | | 75 | 27 | 9 | 3,3 | 1,6 | 0,81 | 0,27 | 0,11 | |
| 43,3 | 2600 | 156 | | | | | | | | | 32 | 10,7 | 4 | 1,9 | 0,98 | 0,32 | 0,13 | |
| 46,6 | 2800 | 168 | | | | | | | | | 37 | 12 | 4,5 | 2,2 | 1,1 | 0,37 | 0,15 | |
| 50 | 3000 | 180 | | | | | | | | | 42 | 14 | 5,25 | 2,45 | 1,22 | 0,42 | 0,17 | |
| 58,3 | 3500 | 210 | | | | | | | | | 56 | 18 | 6,8 | 3,25 | 1,65 | 0,55 | 0,22 | |
| 66,6 | 4000 | 240 | | | | | | | | | 73 | 24 | 8,8 | 4,25 | 2,15 | 0,7 | 0,29 | |
| 75 | 4500 | 270 | | | | | | | | | | 30 | 11 | 5,4 | 2,7 | 0,9 | 0,37 | |
| 83,3 | 5000 | 300 | | | | | | | | | | 37 | 14 | 6,6 | 3,3 | 1,1 | 0,45 | 0,11 |

Notes

Pressure loss should be multiplied by:

- **0,65** for PVC pipes;
- **0,8** for new steel pipes;
- **1,25** for slightly rusty steel pipes;
- **1,7** for encrusted pipes.

Single-phase 230 V 50 Hz

| Motor nominal power | | Cable section in mm ² | | | | | | | | | |
|---------------------------------------|------|----------------------------------|-------|-------|-----|-----|------|------|------|------|------|
| hp | kW | 4x1 | 4x1,5 | 4x2,5 | 4x4 | 4x6 | 4x10 | 4x16 | 4x25 | 4x35 | 4x50 |
| Maximum cable length in meters | | | | | | | | | | | |
| 0,5 | 0,37 | 60 | 90 | 140 | 230 | 340 | | | | | |
| 0,75 | 0,55 | 40 | 70 | 110 | 190 | 280 | 470 | | | | |
| 1 | 0,75 | 35 | 55 | 85 | 135 | 200 | 335 | 525 | | | |
| 1,2 | 0,9 | 30 | 50 | 80 | 120 | 180 | 300 | 470 | | | |
| 1,5 | 1,1 | 25 | 40 | 60 | 100 | 150 | 250 | 395 | | | |
| 2 | 1,5 | | 35 | 50 | 80 | 120 | 190 | 300 | 470 | | |
| 3 | 2,2 | | | 30 | 50 | 70 | 120 | 190 | 300 | 405 | |

Three-phase 400 V 50 Hz

| Motor nominal power | | Cable section in mm ² | | | | | | | | | |
|---------------------------------------|------|----------------------------------|-------|-------|-----|-----|------|------|------|------|------|
| hp | kW | 4x1 | 4x1,5 | 4x2,5 | 4x4 | 4x6 | 4x10 | 4x16 | 4x25 | 4x35 | 4x50 |
| Maximum cable length in meters | | | | | | | | | | | |
| 0,5 | 0,37 | 220 | 340 | 550 | | | | | | | |
| 0,75 | 0,55 | 200 | 300 | 480 | 770 | | | | | | |
| 1 | 0,75 | 150 | 230 | 370 | 600 | | | | | | |
| 1,2 | 0,9 | 130 | 210 | 330 | 530 | | | | | | |
| 1,5 | 1,1 | 100 | 180 | 290 | 470 | | | | | | |
| 2 | 1,5 | 80 | 140 | 220 | 360 | 540 | | | | | |
| 3 | 2,2 | 60 | 100 | 160 | 260 | 390 | 650 | | | | |
| 4 | 3 | 45 | 75 | 120 | 200 | 300 | 500 | | | | |
| 5,5 | 4 | | 55 | 90 | 150 | 220 | 370 | 590 | | | |
| 7,5 | 5,5 | | 40 | 70 | 115 | 170 | 285 | 450 | | | |
| 10 | 7,5 | | | 60 | 90 | 140 | 230 | 360 | 560 | | |
| 12,5 | 9,2 | | | | 75 | 115 | 190 | 300 | 470 | | |
| 15 | 11 | | | | 60 | 90 | 155 | 245 | 380 | 520 | |
| 20 | 15 | | | | | 60 | 110 | 170 | 260 | 360 | 480 |
| 25 | 18 | | | | | | 90 | 140 | 220 | 300 | 395 |
| 30 | 22 | | | | | | 75 | 120 | 185 | 250 | 320 |
| 35 | 26 | | | | | | | 105 | 160 | 215 | 285 |
| 40 | 30 | | | | | | | 90 | 145 | 200 | 260 |
| 50 | 37 | | | | | | | | 110 | 155 | 200 |
| 60 | 45 | | | | | | | | | 130 | 170 |
| 75 | 55 | | | | | | | | | | 140 |

Note

Voltage drop:

- 3 %

Maximum ambient temperature:

- 30 °C

Concept and Art Direction -
Digital post production -
Studiopieri Web & Graphic Agency

Technical features, dimensions and all
other data in this catalogue are not binding.
The manufacturer reserves the right to make any
necessary modifications without prior notice.

June 2018 - Cod 001 - Rev 012

Performances according to
EN ISO 9906:2012 - grade 3B

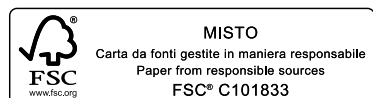



Via G. Di Vittorio, 9
61034 Fossombrone (PU) - Italy
Tel. + 39 0721 716590
Fax + 39 0721 716518
bbcpompe@bbc.it - www.bbc.it